

QST

DEVOTED ENTIRELY TO

AMATEUR RADIO

PUBLISHED SINCE 1915 BY THE AMERICAN RADIO RELAY LEAGUE INC.

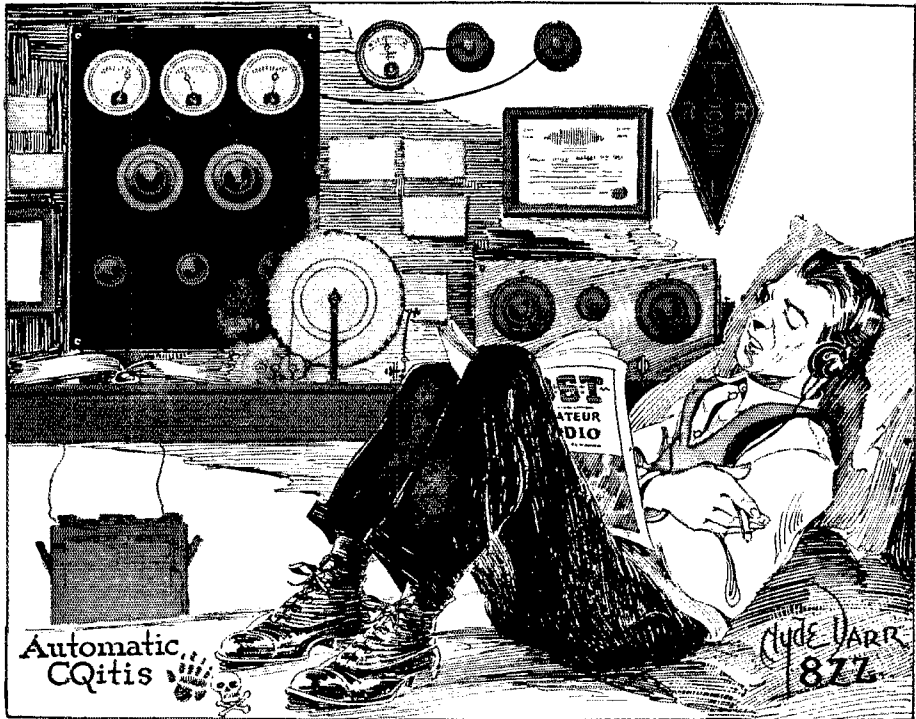

JULY
1928

25^c

RESULTS

From An Efficient Circuit Depend
Primarily Upon the Use of Good Parts

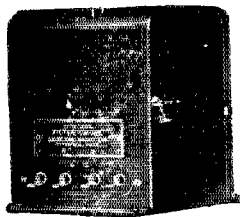

Type 366
FILTER CHOKE
Price \$8.00

Always remember this fact in set-building. General Radio apparatus has long been recognized by radio editors, test laboratories, and experimenters as the standards of radio.

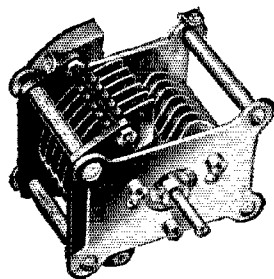

Type 334T
TRANSMITTING
CONDENSER
Price \$4.25

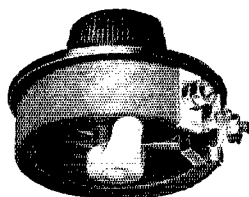

Type 214A
RHEOSTAT
Price \$2.25

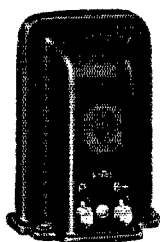

Type 285
AUDIO TRANSFORMER
Price \$6.00

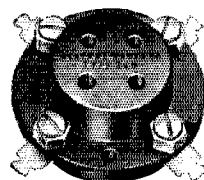

Type 349
SOCKET
Price 50c

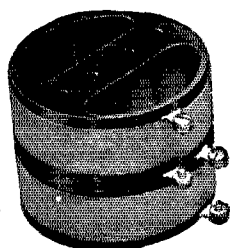

Type 277C
INDUCTANCE COIL
Price \$1.25

Your correspondence is welcome in regards to technical problems. Bulletin No. 929 describing our complete line of radio apparatus will be sent on request.

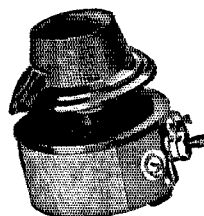

Type 410
RHEOSTAT
Price \$1.25

GENERAL RADIO Co

30 State St., Cambridge, Mass. 274 Brannan St., San Francisco, Calif.

In the finest sets Faradon



AT the R. M. A. Show the latest and finest radio equipment is presented.

Playing no small part in this advanced standard of quality and dependability is the Faradon Capacitor, specified by manufacturers because of satisfactory service rendered.

Twenty years of electrical engineering skill and highest quality materials have made Faradon Capacitors the standard of electrostatic condenser long life and dependability.

Faradon engineers are always ready to co-operate with you on special equipment which cannot be taken care of by the more than 200 Faradon Capacitors in regular production.

Wireless Specialty Apparatus Company
Jamaica Plain, Boston, Mass., U.S.A.

Established 1907

Faradon

Electrostatic Condensers for All Purposes

Take the Advice of Leading Radio Service Organizations

Play safe with **PARVOLTS!**

IF you want the real truth about condensers go to an organization that builds, services and repairs every type of radio receiver and power supply unit.

Such an organization is Rossiter, Tyler & McDonell. These engineers have had actual experience in every branch of radio. Mr. Frank McDonell says:

"We think so well of ACME PARVOLT Condensers that we have samples constantly on display for all clients to see. Those of our customers who know radio also know that PARVOLTS are thoroughly reliable. We like our clients to realize that we use the best in radio."

Mr. McDonell says that his firm has used many ACME PARVOLTS in both experimental and practical work and has never known one to break down under proper load. Absolute safety is vital with a firm doing a large volume of service work.

Should a condenser

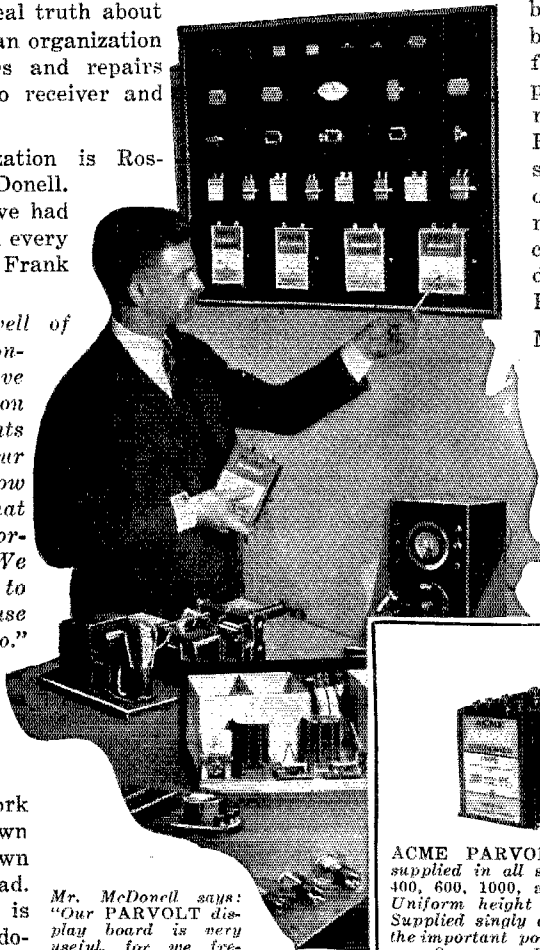

Mr. McDonell says: "Our PARVOLT display board is very useful, for we frequently have occasion to show our clients how these condensers are made."

blow out, many dollars would be lost in ruined tubes, transformers, chokes and other parts. The experience of the nationally known house of Rossiter, Tyler & McDonell should be a good guide for other builders and service men to follow. Don't take chances with condenser break down. Play safe with ACME PARVOLTS.

Made by THE ACME WIRE CO., New Haven, Conn., manufacturers of magnet and enameled wire, varnished insulations, coil windings, insulated tubing and radio cables.

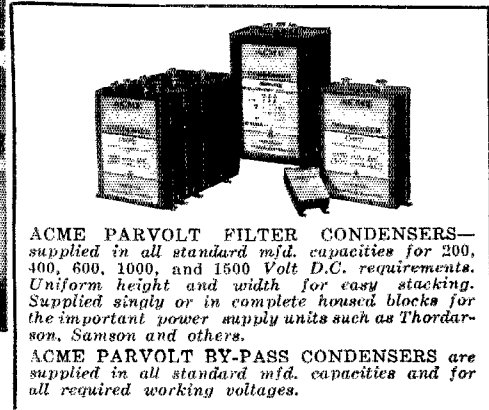

ACME PARVOLT FILTER CONDENSERS—supplied in all standard mfd. capacities for 200, 400, 600, 1000, and 1500 Volt D.C. requirements. Uniform height and width for easy stacking. Supplied singly or in complete housed blocks for the important power supply units such as Thordarson, Samson and others.

ACME PARVOLT BY-PASS CONDENSERS are supplied in all standard mfd. capacities and for all required working voltages.

ACME PARVOLT CONDENSERS

Made by the Manufacturers of

ACME CELATSITE HOOK-UP WIRE

ENAMELED AERIAL WIRE

Enameled copper wire in both stranded and solid types. Also Acme Leads, Battery Cables, Insulor and Loop Aerial Wire.

CELATSITE FLEXIBLE and SOLID

For all types of radio wiring. High insulation value; non-inflammable. 10 colors.

ACME SPAGHETTI

A superior cambric tubing for all practical radio and other electrical requirements. Supplied in 10 colors.

Section Communications Managers of THE COMMUNICATIONS DEPARTMENT, A. R. R. L.

		ATLANTIC DIVISION	
Eastern Pennsylvania	5QP	J. B. Morgan, 2nd	431 E. Willow Grove Ave. Chestnut Hill, Phila
Maryland-Delaware-District of Columbia	3A18	Dr. H. H. Layton	805 Washington St.
Southern New Jersey	3CFQ	M. J. Lotysh	Box 49, RFD 1
Western New York	8PJ	C. S. Taylor	598 Masten St.
Western Pennsylvania	CEO	A. W. McAulry	399 Third St.
		CENTRAL DIVISION	
Illinois	9APY	Fred J. Hinds	3337 Oak Park Ave.
Indiana	9CYQ	D. J. Angus	310 N. Illinois St.
Kentucky	9ARU	D. A. Downard	116 No. Longworth Ave.
Michigan	3CEP	Dallas Wise	9187 Falcon Ave.
Ohio	8BYN	H. C. Storz	694 Carpenter St.
Wisconsin	9VD	C. N. Crapo	443 Newton Ave.
		DAKOTA DIVISION	
North Dakota*	9DM	H. L. Sheets	
South Dakota	9DR	F. J. Beck	
North Minnesota	96AH	C. L. Barker	
South Minnesota	9BYA	D. F. Cottam	3538 Third Ave. So.
		DELTA DIVISION	
Arkansas*	5ABI	H. E. Votto	5498 U St.
Louisiana	3UK	C. A. Freitag	129 Camp St.
Mississippi	5AKP	J. W. Gullett	1708 23rd Ave.
Tennessee	4KM	L. K. Rush	4 Second St.
		HUDSON DIVISION	
Eastern New York	2CNS	F. M. Holbrook	2 Livingston Ave.
N. Y. C. & Long Island	2CWK	F. H. Mardon	1399 W. Paris Rd.
North New Jersey	2WR	A. G. Wester, Jr.	59 Princeton St.
		MIDWEST DIVISION	
Iowa*	9DZW	H. W. Kerr	
Kansas	9DNG	F. S. McKeever	1325 W. Campus Rd.
Missouri	9RB	L. B. Lutz	8010 Mercer St.
Nebraska	9BYG	C. B. Deihl	5665 Cedar St.
		NEW ENGLAND DIVISION	
Connecticut	1ZL	C. A. Weidenhammer	33 Washington Place
Maine	1BG	Frederick Best	13 E. Crescent St.
Eastern Massachusetts	1UE	E. L. Batty	39 Royal St.
Western Massachusetts	1UM	Dr. John A. Tessmer	83 Schaffner St.
New Hampshire	1ATY	V. W. Hodges	227 Main St.
Rhode Island	1RYR	D. B. Fancher	9 1/2 Hobart St.
Vermont	1AJG	C. T. Kerr	
		NORTHWESTERN DIVISION	
Alaska		W. B. Wilson	U. S. LIFE Fern
Idaho	7ST-7ALD	Henry Fleischer	1610 N. 10th St.
Montana	7AAT-7QT	O. W. Viers	
Oregon	7PP	R. H. Wright	310 Ross St.
Washington	7ED	Otto Johnson	4340 30th Ave. W.
		PACIFIC DIVISION	
Hawaii	6CFQ	F. L. Fullaway	2714 Manoa Rd.
Nevada	6UO	C. B. Newcombe	
Los Angeles	6AM	D. C. Wallace	109 W. Third St.
Santa Clara Valley	6NX	F. J. Quement	232 Hanchett Ave.
East Bay	6CZR	J. Waller Frates	368 62nd St.
San Francisco	6YR	J. W. Patterson	400 Octavia St. Apt. 29
Sacramento Valley	6CRS	C. F. Mason	2539 N. St.
Arizona	6ANO	H. B. Lamb	229 W. First St.
Philippines*	opLAT	Jose E. Jimenez	835 San Fernando St.
San Diego	6BQ	G. A. Sears	236 Bonair St.
		ROANOKE DIVISION	
North Carolina	4JR	R. S. Morris	413 S. Broad St.
Virginia	3CA	J. P. Wohlford	118 Cambridge Ave.
West Virginia	8HD	C. S. Hoffman	126 Chantal Court
		ROCKY MOUNTAIN DIVISION	
Colorado	9CAA	C. R. Stedman	1641 Albion St.
Utah-Wyoming	6RM	Don C. McRae	211 Belvedere Apts.
		SOUTHEASTERN DIVISION	
Alabama	5AJP	A. D. Trum	217 Catoma St.
Florida	4LK	C. E. Foulkes	502 Spearinx St.
Georgia-South Carolina-Cuba-Porto Rico-Isle of	4KU	H. L. Reid	11 Shadowlawn Ave.
		WEST GULF DIVISION	
Northern Texas	5AKN	J. H. Robinson, Jr.	522 Cumberland St.
Oklahoma	5APG	K. M. Ehret	2904 N. Robinson St.
Southern Texas	5YK	E. A. Sahn	146 N. Academy St.
New Mexico	5TT	L. E. Rauka	Box 185
		MARITIME DIVISION	
Newfoundland	8AR	Loyal Reid	Avalon House
New Brunswick	1EI	T. B. Lacey	c/o N. B. Power Co.
Nova Scotia	1DD	W. C. Borrett	14 Sinclair St.
Prince Edward Island	1BZ	P. W. Hyndman	25 Fitzroy St.
		ONTARIO DIVISION	
Ontario	9BJ	W. Y. Sloan	167 Close Ave.
		QUEBEC DIVISION	
Quebec	2BE	Alex Reid	169 Logan Ave.
		VANALTA DIVISION	
Alberta	4HA	E. J. Taylor	10107-87th Ave.
British Columbia	5BJ	E. S. Brooks	c/o Forestry Dept. Radio
		PRAIRIE DIVISION	
Manitoba	4FV	D. B. Sinclair	205 Cambridge St.
Saskatchewan	4FO	W. J. Pickering	514 19th St. W.

*Temporary officials appointed to act until the membership of the Section concerned choose permanent SCMs by the mountain and election.

Get it Better with a Grebe



Hundreds of invisible beacons planted along the Channel coast from Plymouth to Carlisle suddenly flashed into flame upon the approach of the Spanish Armada, arousing England to the valiant defense that resulted in the destruction of this supposedly invincible fleet.

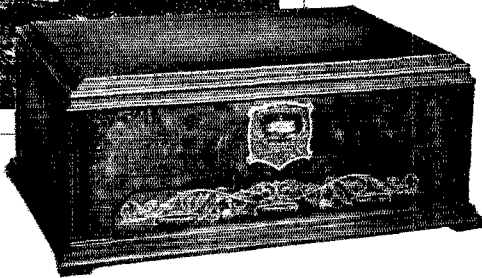

Invisible Value—is an intangible quality of the Grebe Synchronphase A-C Six. It is an inbuilt quality that cannot be copied. It is the basis upon which for nineteen years all Grebe radios have been made and sold.

The Grebe standards of craftsmanship and materials, the real secret of this *invisible value*, never have been more clearly typified than in the Grebe Synchronphase A-C Six. Its remarkable selectivity, fidelity of tone and distinctive Grebe innovations have



brought immediate success. It offers a complete demonstration of the difference between a radio, built just to meet price conditions, and one whose quality must be upheld to maintain a reputation.

Also Grebe Synchronphase Seven; Grebe Synchronphase Five; Grebe Natural Speaker; Grebe No. 1750 Speaker.

Hear the Grebe Synchronphase A-C Six today, or send for Booklet Q, which fully explains this new receiver.

GREBE

SYNCHROPHASE
TRADE MARK REG. U.S. PAT. OFF.

A-C Six

RADIO

A. H. Grebe & Company, Inc., 109 West 57th Street, New York City
 Factory: Richmond Hill, N. Y. Western Branch: 443 S. San Pedro St., Los Angeles, Cal.
 Makers of quality radio since 1909

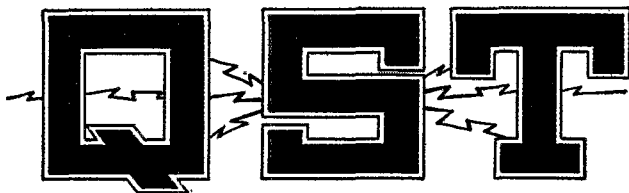

The Official Organ of the A.R.R.L.

VOLUME XII

JULY, 1928

NUMBER 7

Editorials	7
Frequency Precision	<i>Hiram Percy Maxim</i> 8
Standard Frequency Transmissions from WWV	8
Some Notes on a Visit to the Naval Research Laboratory	<i>Ross A. Hull</i> 9
New England Division Convention	12
What is Amateur Radio Traffic?	<i>Paul M. Segal</i> 13
Vanalta Division Convention	18
1XV-1XAN	<i>Gordon G. Macintosh</i> 19
A Phone Transmitter for the Beginner or Advanced Amateur	<i>R. Wm. Tanner</i> 23
Notes on Filter Circuit Design	<i>D. E. Replogle & James Millen</i> 27
Some More About the Family	<i>A. B. Chamberlain</i> 29
The Hudson Division Convention	31
A Super-Regenerator for Short Waves	<i>George B. Hart</i> 32
Relays for the Amateur	<i>G. F. Lamplin</i> 33
Official Wavelength Stations	36
Tests on a Method of Voltage-Feeding the Antenna	<i>Joseph Fuchs</i> 37
Becoming an Operator in 15 Minutes	<i>Don C. Wallace</i> 38
Filament Supply Progress	<i>W. J. Halligan</i> 39
A Resonance Testing Method	<i>A. E. Teachman</i> 41
Concerning Amplified Absorption Modulation	<i>Severiano Justi</i> 42
A Simple High Frequency Oscillator	<i>William H. Christie</i> 43
Reducing the Cuss-Quotient	<i>Jack Paddon</i> 44
A Mounting for Space-Wound Coils	<i>Guy E. Pigford</i> 45
Communications Department	47
I. A. R. U. News	60
Calls Heard	61
Correspondence	62
Central Division Convention	86
Hamads	91
QRAs	98

QST is published monthly by The American Radio Relay League, Inc., at Hartford, Conn., U. S. A.
Official Organ of the A.R.R.L. and the International Amateur Radio Union

Kenneth B. Warner (Secretary, A.R.R.L.),
Editor-in-Chief and Business Manager

F. Cheyney Beekley,
Managing Editor and Advertising Manager

Harold P. Westman,
Technical Editor

Ross A. Hull,
Associate Technical Editor

David H. Houghton,
Circulation Manager

Subscription rate in United States and Possessions, Canada, and all countries in the American Postal Union, \$2.50 per year, postpaid. Single copies, 25 cents. Foreign countries not in American Postal Union, \$3.00 per year, postpaid. Remittances should be by international postal or express money order or bank draft negotiable in the U. S. and for an equivalent amount in U. S. funds. Entered as second-class matter May 29, 1919, at the post office at Hartford, Connecticut, under the act of March 3, 1879. Acceptance for mailing at special rate of postage provided for in section 1103, Act of October 3, 1917, authorized September 9, 1922. Additional entry as second-class matter, acceptable at special rate of postage provided for above, at Springfield, Mass., authorized September 17, 1924.

Copyright 1928 by the American Radio Relay League, Inc.. Title registered at United States Patent Office.
Member of the Radio Magazine Publishers' Association.

The American Radio Relay League

The American Radio Relay League, Inc., is a non-commercial association of radio amateurs, bonded for the promotion of interest in amateur radio communication and experimentation, for the relaying of messages by radio, for the advancement of the radio art and of the public welfare, for the representation of the radio amateur in legislative matters, and for the maintenance of fraternalism and a high standard of conduct.

It is an incorporated association without capital stock, chartered under the laws of Connecticut. Its affairs are governed by a Board of Directors, elected every two years by the general membership. The officers are elected or appointed by the Directors. The League is non-commercial and no one commercially engaged in the manufacture, sale or rental of radio apparatus is eligible to membership on its board.

"Of, by and for the amateur", it numbers within its ranks practically every worth-while amateur in the world and has a history of glorious achievement as the standard-bearer in amateur affairs.

Inquiries regarding membership are solicited. A bona fide interest in amateur radio is the only essential qualification; ownership of a transmitting station and knowledge of the code are not prerequisites. Correspondence should be addressed to the Secretary.

Directors

- | | | |
|---|--|---|
| <p><i>President</i>
 HIRAM PERCY MAXIM
 Drawer 2102,
 Hartford, Conn.</p> <p><i>Vice-President</i>
 CHARLES H. STEWART
 St. David's, Pa.</p> <p><i>Canadian General Manager</i>
 A. H. K. RUSSELL
 5 Mail Bldg.,
 Toronto, Ont.</p> <p><i>Atlantic Division</i>
 DR. EUGENE C. WOODRUFF
 234 W. Fairmount Ave.,
 State College, Pa.</p> <p><i>Central Division</i>
 CLYDE E. DARR
 187 Hill Ave., Highland Park,
 Detroit, Mich.</p> | <p><i>Dakota Division</i>
 C. M. JANSKY, JR.
 Dept. of Elec. Eng., U. of M.,
 Minneapolis, Minn.</p> <p><i>Delta Division</i>
 BENJ. F. PAINTER
 424 Hamilton Nat'l Bank Bldg.,
 Chattanooga, Tenn.</p> <p><i>Hudson Division</i>
 DR. LAWRENCE J. DUNN
 480 East 19th St.,
 Brooklyn, N. Y.</p> <p><i>Midwest Division</i>
 PORTER H. QUINBY
 817 Lauderman Building,
 St. Louis, Mo.</p> <p><i>New England Division</i>
 DR. ELLIOTT A. WHITE
 Dartmouth College,
 Hanover, N. H.</p> <p><i>Northwestern Division</i>
 K. W. WEINGARTEN
 3219 No. 24th St.,
 Tacoma, Wash.</p> | <p><i>Pacific Division</i>
 ALLEN H. BABCOCK
 65 Market St.,
 Southern Pacific Co.,
 San Francisco</p> <p><i>Roanoke Division</i>
 W. TREDWAY GRAVELY
 Box 245,
 Danville, Va.</p> <p><i>Rocky Mountain Division</i>
 PAUL M. SEGAL
 Box 1771
 Denver, Colo.</p> <p><i>Southeastern Division</i>
 HARRY F. DOBBS
 c/o Dobbs & Wey Co.,
 245 Spring St., N. W.,
 Atlanta, Ga.</p> <p><i>West Gulf Division</i>
 FRANK M. CORLETT
 2515 Catherine St.,
 Dallas, Tex.</p> |
|---|--|---|

Officers

- | | |
|---|---|
| <i>President</i> | HIRAM PERCY MAXIM, Hartford, Conn. |
| <i>Vice-President</i> | CHAS. H. STEWART, St. David's, Pa. |
| <i>Secretary</i> | KENNETH B. WARNER, Hartford, Conn. |
| <i>Treasurer</i> | ARTHUR A. HEBERT, Hartford, Conn. |
| <i>Communications Manager</i> | F. EDWARD HANDY, Hartford, Conn. |

Address General Correspondence to Executive Headquarters, Hartford, Conn.

EDITORIALS

WE'RE getting all steamed up about the possibilities of our 10-meter band. With this band opened to amateur occupancy but a few weeks, transatlantic and transcontinental daylight work already have taken place. Good signals from low power, too, and no particular difficulty about holding the frequency steady enough to work. A number of stations on each coast are having a great old time blasting away in transcontinental work all through the daylight hours of each week-end, pioneering in the new region and giving a demonstration to the Federal Radio Commission and the world at large that the American amateur will find a way. If foreign amateurs would get going on the 30-Mc. band we'd surely have some nice international DX.

Such frequencies are supposed to be useless for ordinary communications. We may well wonder how it happened that these useless frequencies seemed to yield the moment we tackled them. We're entitled to be decidedly suspicious of the situation. How does it happen? Is the joy going to be taken out of life by the discovery that there is something bug-house about this business? That is exactly what Dr. Taylor of the Naval Radio Research Laboratory tells us. He says that the Kennelly-Heaviside Layer has been most abnormally low for some months and that that could well explain our success. When it rises to where it belongs, he says (and it threatens to do so immediately, now that our organized 30-Mc. tests have started), we oughtn't to hear a thing with the methods we are now employing.

Well, we shall see. Considering that 30 Mc. is normally useless even for communication with the Antipodes, that Layer must have strayed a great long ways from home to make our recent communications accord with current theories. If everything goes blotto on 30 Mc. soon, we'll have to accept the theory and look around for methods that offer greater promise. All of the work to date seems to have been done along perfectly conventional lines with half-wave Hertzian antennas or with the usual amateur antenna operating at some harmonic. As far as we know not one of the hundred-or-so stations experi-

menting on this band is using a reflector. Theory indicates the need for controlling the angle of radiation before 10 meters will do its stuff. Horizontal reflectors seem likely to help. A. Meissner of Berlin describes some interesting work at an 11-meter Telefunken station in last November's *Proceedings of the I.R.E.* The station communicated with South America. A horizontal antenna was used, with a horizontal reflector under it, and the reflector could be rotated to change the angle of reflection. Best results with South America were found at 38 degrees from the horizontal, but almost as good results were had at 80 degrees, nearly vertical. Try and figure that out! According to Hoyle and Taylor—we mean Hulbert and Taylor—that wave, if it got reflected at all, would have to make some hundreds of reflections before it zigzagged to Rio, and Hertz himself wouldn't be able to recognize it when it got there.

Which leads us to a gorgeous idea. It probably isn't any good but the concept is magnificent. We know that because we got it up ourselves. Why not use one of Prof. Hertz' horizontal antennas, one of Herr Meissner's horizontal reflectors, and a few of Dr. Yagi's horizontal directors, direct the beam substantially vertically, and there let it shatter itself to bits against Prof. Kennelly's well-known Layer, to splatter down R9 signals all over the world to the utter confounding of all Taylor skip-zones! Just like a fire-hose, with its nozzle pointed at the center of the ceiling, would provide a sure-fire method of wetting down every square inch of the floor in jig time. This idea, if it works, must be known as the Warner Splatter System, or the Splatter Warner System as the case may be. Otherwise it is conveyed free of charge to a breathless world. No more fade-outs, no more skips, one wave for any distance. I'm Queen of the May and, besides, Napoleon and I have a date and anyhow I'm not going riding in the black wagon, Officer!

But seriously, stranger things have happened. We present the dizzy idea feeling that this is one page in *QST* in which we can be technically unsound if we want to be to illustrate an idea. Our thought is to suggest that the ultimate taming of 30 Mc. may

well involve the evolution of gear and of methods radically different from those we employ to-day, so that departure from conventional lines and independent and constructive thinking are to be encouraged. The

goal is well worth it. That 10-meter band contains more channels than we have at 20 meters and 40 meters combined, and we shall need them badly next year. Hail, then, the 10-meter pioneers!

K. B. W.

Frequency Precision

By Hiram Percy Maxim, President A.R.R.L.

If somebody were to ask you the question, 'What is the big outstanding problem in amateur radio today?', what would you reply? It was asked me the other day. I had given the matter considerable thought, so I was ready with my reply. My answer was, 'FREQUENCY PRECISION.'

Come next January first, every radio station in the world must positively be on its assigned frequency or in its assigned frequency band. That's when the new international treaty regulations go into effect. When one of us American amateurs gets outside our bands after next January first it becomes an international offense. If a Turkish station is bothered by one of us, diplomatic representations will be made to Washington, and the entire U.S. Government machinery must, if necessary, be set in motion to see that it does not happen again. Our treaty promises require this.

Let it be a frequent occurrence, to have foreign governments complaining to Washington that American amateurs are transmitting outside their assigned bands—what is likely to happen then? It makes one shudder. To put it mildly, amateur radio is likely to get hurt. Therefore, this question of FREQUENCY PRECISION.

As we climb up into the super frequencies, as we do when we use forty meters and below, frequency precision becomes a problem of the first magnitude. But we have been confronted with technical problems in radio engineering that are of the first magnitude for fifteen years. And we have mastered every one of them. We shall master this one. But in the process there are those among us who are going to get badly hurt. The moral is—FOR GOODNESS' SAKE GET INSIDE YOUR BAND AND STAY INSIDE.

Standard Frequency Transmissions from WWV

UNFORTUNATELY the "headway" allowed at the Bureau of Standards is insufficient for a monthly magazine, hence we must as usual drop off some of the current schedule sheet since it will be obsolete before it can be printed and sent to our readers.

The details of these transmissions have been given many times in the past and are in fact self-explanatory if the transmission is listened to carefully.

Because there has been criticism in this regard, it is but fair to call attention to the fact that it is perfectly proper and correct for certain regions to be unable to

hear certain of the frequencies from WWV. This does not in any way prove that WWV is an inferior station, but simply confirms the fact that some frequencies are not suited for certain distances. The very good record of WWV in being received consistently over a large part of the world is in itself proof that such talk is nonsense.

Schedule of Frequencies in Kilocycles.

Eastern Standard Time	July	Aug.	Sept.	Oct.
10:00-10:08 P.M.	3000	125	300	650
10:12-10:20	3300	150	350	750
10:24-10:32	3600	175	400	850
10:36-10:44	4000	200	450	950
10:48-10:56	4400	225	500	1050
11:00-11:08	4900	250	550	1200
11:12-11:20	5400	275	600	1350
11:24-11:32	6000	300	650	1500

Some Notes On a Visit to the Naval Research Laboratory

By Ross A. Hull*

IF you could stroll into the radio shack of an amateur in Timbuktu or, for that matter, in Tibooburra (yes, that's in Australia) and could make mention to its owner in some way of the call "NKF", his face would be illuminated, without doubt, by a light of understanding. "Ah!"

nificance accomplishing great things in the most delightfully direct and unassuming manner possible. It is, he finds, the sort of place in which amateurs, in their dreams, find themselves permitted to twiddle knobs, jiggle clips and wreck 250 watters for evermore.

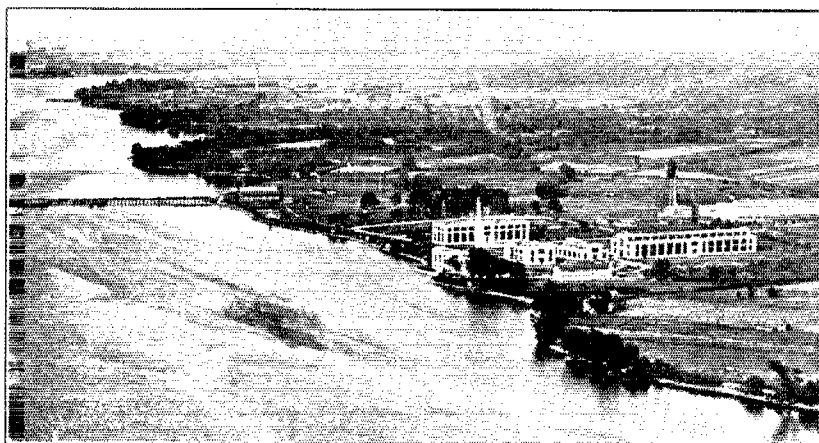

"THE VERY PLAYGROUND OF SHORT WAVES, SKIP DISTANCES AND KENNELLY-HEAVISIDE LAYERS"

At the extreme left, near the horizon, is the dome of the Capitol in Washington. The large open area near the top centre of the picture is famed Bolling Field. On the right sit the buildings of the Naval Research Laboratory.

Photo Courtesy U.S. Navy

he would gurgle in more or less broken English, "at Washington—ah yes, the Naval Research Laboratory." For of all the centers of activity in short-wave radio development, none has quite the same appeal to the amateur as that at Bellevue near Washington. NKF, the call used for experimental work, has provided a grand thrill for the thousands of amateurs who have communicated with the Naval experimental stations using it; and NKF and the Naval Research Laboratory have always been synonymous. Then, to the amateur, Bellevue will always be known as the very birthplace of practical crystal controlled transmitters†. To the amateur visiting the place, however, it is more, much more than this. It is to him the one brilliant example of a laboratory of the highest sig-

Bellevue, as we found on arriving in Washington, is not in or even near the latter city. It is just \$2.50 away by taxi if the meter is not out of adjustment. The drive is through thickly populated suburban areas as far as the famed Bolling Field but soon after that the road breaks away into open rolling country, with heavy hedges and a wealth of foliage crowding the road on both sides. The brilliant white buildings of the Naval Research Laboratory sit off in a neat group on the river flats right at the banks of the Potomac. In fact, if one jumped from one of the several dozen antennas available, one could readily lob in the muddy waters of that famous stream.

Of course, we put on our best cool-calm-and-collected manner as we wandered around from laboratory to laboratory with Commander A. Hoyt Taylor, U.S.N.R.F., and agreed in our most *blazé* tone that of course it was desirable to have equal inductive paths between units in the high

*Associate Technical Editor, QST. In charge A.R.R.L. Technical Development Program.

†"Navy Developments in Crystal-Controlled Transmitters," QST, November, 1925.

voltage condenser bank but inwardly we were pop-eyed. For was not this *The Naval Research Laboratory*—the very playground of short waves, skip distances, and Kennelly-Heaviside layers! And here we were, inside its walls, squizzing with apparent unconcern its jungles of frequency standards,

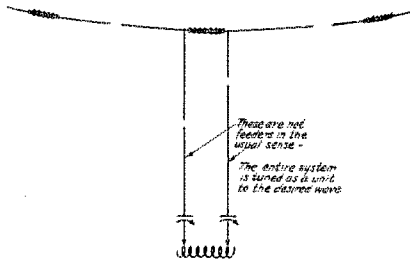

FIG. 1. THE FOLDED CURRENT-FEED ANTENNA

For 20-meter operation the entire system would be tuned to 20, 60 or 120 meters in order to place a current loop at the inductance. For 40-meter work the antenna would be tuned to 40, 120 or 200 meters.

constant temperature chambers, harmonic amplifiers and oscillators of every conceivable type; its maze of receivers and screen-grid amplifiers, its transmitters and antennas and more transmitters and still more antennas! At the end of the day, we were happy. At least we had seen everything. With all our artificial unconcern, we had

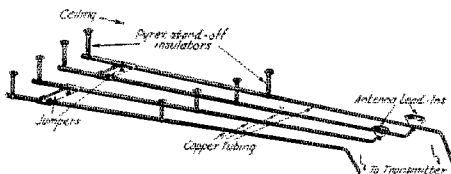

FIG. 2. THE "TROMBONE" ANTENNA TUNING SYSTEM

managed to get a sharp and searching look at all there was therein. Of course, a great many things we saw, though intensely interesting, had no particular significance for us. Either we failed to understand them or else they were built around 20 Kw. tubes or equally un-amateur apparatus. Just once in a while, however, perhaps buried in the circuits of a pair of 500-watt screen-grid amplifiers, we would see something that caught our amateur eye. And it is about these odd things that we originally intended to write.

We observed, for instance, that where "forced-feed" untuned antennas were not used, a folded current-feed affair could be

found almost invariably. For general non-directional transmission, it was explained, the arrangement shown in Fig. 1 proved thoroughly practical and satisfactory. There is nothing new about the antenna. It is the same rig (tuned to a harmonic that gives a current anti-node at the inductance) that some amateurs have used for years, but it was splendid to find that it was used by the Naval engineers. When our new antenna goes up, we thought, after we have proved to ourself on paper that a three-quarter wave long tuned feeder is the best, we will crawl onto the roof with a coil of wire and put up a folded current feed affair with full confidence. "Anyway," we will be able to think, "the Navy uses it". Then, we might try the "trombone" antenna tuning system used by Dr. Taylor on the experimental 20 Kw. 21,000 Kc. (14.28-meter) transmitter at the "field station". It is arranged as shown in Fig. 2, the tuning of the antenna being accomplished by the simple expedient of sliding the "jumpers" to or from the lead-ins. As the "jumpers" are moved away from the lead-ins, the wavelengths of the system is, of course, increased.

The actual "trombone" system was built of heavy copper tubing suspended from the ceiling with large pyrex stand-off insulators but there is no reason why the amateur should not obtain results with heavy antenna wire strung tightly across the room and fitted with ordinary pyrex antenna insulators.

While on the subject of antennas, we must mention the antenna coupling used on the experimental 21,000 Kc. transmitter. The plate inductance of the "tank" of the final amplifier tubes consisted of an incomplete rectangle of about $\frac{3}{4}$ " copper tubing, the small sides consisting of movable "jumpers" to permit rough adjustment. The plate leads from the amplifier tubes were taken to heavy clips spaced about eighteen inches on the long side of the rectangle and the two antenna leads were taken from clips on the same rod spaced about nine inches. Here was a mere twenty kilowatts being tapped off a nine-inch length of tubing!

For general reception, it would seem that no special type of antenna is used, but we were deeply interested in the evidences to be found of extensive experiment in directional reception. The "wire fence" Beverage system shown in Fig. 4 would seem to be splendidly adaptable to special amateur work. The system consists essentially of two "feeders" spaced about six inches to which are connected, at intervals of a few feet, short "collectors". The system in use at Bellevue was five wavelengths long and had collectors extending about three feet on each side of the "feeders". It

would seem, however, that even a single-wavelength long antenna shows marked directional qualities and that "feeder" spacings and "collector" lengths are not matters of any great importance. Dr. Taylor, in discussing the merit of the arrangement in reducing interference and improving the background-signal ratio, suggested that if the "collectors" were arranged in a horizontal instead of a vertical plane an even greater reduction in background noises probably could be secured on account of the marked vertical polarization of waves arriving from near-by sources of interference.

Our first impression on entering those laboratories devoted to the development of receivers and transmitters was that no tube circuits were considered complete unless they were "push-pull". The screen-grid tubes of the short-wave radio frequency amplifiers were arranged in "push-pull" fashion and were followed, in all of the new receivers with "push-pull" detectors. In the transmitters (which are crystal controlled almost exclusively), "push-pull" crystal oscillators were followed by "push-pull" amplifiers in each stage. Nowhere

watts or more of output), there would be, without question, loud yells of horror. Yet in the typical Bellevue transmitter two such tubes, operated in just that manner, are used to excite a pair of 250-watt frequency doublers and these, in turn, serve to drive a pushing and pulling pair of 10-kilowatt ether wreckers. The three tubes following

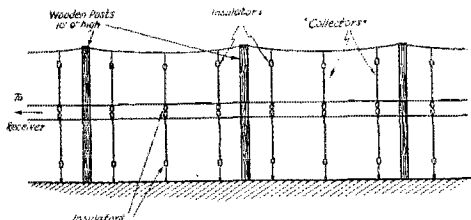

FIG. 4. A SECTION OF THE SPECIAL BEVERAGE RECEIVING ANTENNA

The system, detailed in the text, has the disadvantage, for amateur work, of being so splendidly adapted for use as a trellis for the family's sweet peas.

the crystal in the more conventional transmitter would be a 201A, a 171, and maybe, a 210! Of course, not all crystals can be operated in the Navy manner, as we know from sad experience, but when cut and ground correctly, it has been shown definitely that they can withstand the treatment described without heating unduly, without consequential frequency drift, and without any unusual danger of cracking.

Another feature which permits a valuable reduction in the number of necessary stages of amplification is the unusual method used for frequency doubling and trebling. By its use, a very much greater power step-up can be obtained in the amplifiers than is possible with the ordinary scheme of plucking harmonics from the amplifier plate "tank". The method, we discovered, is to run the grid bias of the amplifier tube far above the usual value to the point where the tube draws plate current only when the exciting voltage from the oscillator or previous amplifier is near the peak of its positive half cycle. If the amplifier is to be used as a frequency doubler its plate circuit is tuned to the double frequency and its bias is adjusted to the point where plate current is passed during that fraction of the positive half cycle of the exciting voltage which corresponds to one half cycle of the new frequency. The amplifier "tank" will, under these conditions, be given a jolt on every other positive half cycle, and so will be maintained in a condition of oscillation. When the frequency is to be trebled, the bias is run still higher so that the time interval is reduced to correspond to a half cycle of the new frequency. Surprising

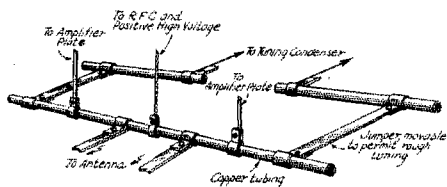

FIG. 3. THE PLATE "TANK" OF THE 20-Kw. 21,000 Kc. EXPERIMENTAL TRANSMITTER

A large incomplete rectangular turn is used for the plate "coil" and the 20 Kw. of antenna power is tapped from a nine-inch section of it.

could a tube be seen without its "push-pull" companion. In the receivers, the scheme is employed on account of the stability, ease of adjustment and gain provided by it. In the transmitters, the arrangement permits doubled power output from the crystal oscillator and from each amplifier stage. In addition, it allows a beautifully symmetrical mechanical arrangement of the tubes and their circuits, and correspondingly effective neutralizing of the various stages.

Navy practice in the operation of crystal controlled transmitters is, by the way, unique. If one should go to any of the centers of learning and activity in New York State or Massachusetts and suggest that the crystal be connected to the grids of a couple of 50-watt tubes supplied with 400 volts at about 250 m.a.—with 10 amperes in its plate "tank" (representing 50

overall efficiencies are obtained in the amplifiers operated in this manner, values of 40 to 45 percent for frequency doublers and 30 to 35 percent for frequency treblers not being unusual. When we get around to our new crystal control rig, we surely will incorporate this stunt.

In proceeding through the various laboratories, we came across, from time to time, some new experimental transmitter in the process of adjustment and we could

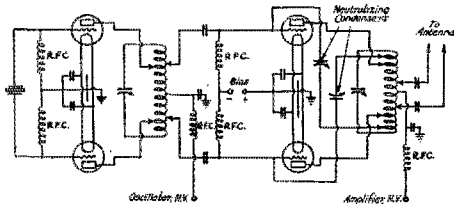

FIG. 5. A TYPICAL "PUSH-PULL" CRYSTAL-CONTROL OSCILLATOR AND AMPLIFIER

Coil sizes and Condenser capacities are of the same order as those in the usual type of crystal-control transmitter. For the sake of clearness the filament supply leads and center-tap have been eliminated.

not help being impressed by the precise and methodical manner in which the adjustment and tuning was carried out. In the first place, the engineers showed clearly that appreciation of the danger of high voltage supplies which is usually so lacking in amateur ranks. Even in the low powered rigs tuning was accomplished either with the power off or with the aid of a most convenient "tuning stick" consisting of a length of bakelite rod $\frac{5}{8}$ " in diameter bound with 'friction tape' at one end and fitted with a wire loop at the other. The taped end was used to rotate dials while the loop served to manipulate switches. The general usefulness of the gadget and the facility with which it was used made us decide right then and there to build one when we got home. Another thing we decided to rig is a portable key and power switch of the type used at Bellevue. The arrangement is simply a key and switch mounted on a small board and connected through two long pairs of flexible leads to the transmitter. This "portable key" can then be carried across the room, if necessary, as adjustments are carried out, and can be placed on the floor and operated by foot should both hands be required for adjustments of manipulation.

As the day wore on and laboratory followed laboratory, we became more and more surprised at the extent of the work being conducted and the novelty and interest of it all. The more we write about it, how-

ever, the more we become convinced of our inability either to tell the whole story or to create a complete and accurate impression of the few matters mentioned. Even so, we must tell of our visit, late in the afternoon, to the "field house" a half mile or so from the main buildings. It was here that we were permitted actually to "assist" Dr. Taylor and his assistant in the tuning of the 20-Kw., 21,000-Kc. transmitter.

The larger experimental transmitters, where 10,000 volts or more are in evidence, are tuned by at least two engineers who keep well clear when the power is on. "Power off," yells the engineer at the switch to the other when adjustment is to be made. "Power off," repeats the second engineer before either of them move. When the alteration has been made, the warning "High voltage coming" is yelled by the man at the switch. Those same words must be echoed by the second man before the switch is thrown.

Aside from this procedure, the tuning business was just like the tuning of a "ham" station on a very large scale. Our part was the adjustment of the "jumpers" on the "trombone" and this was "hammy" enough for us to feel very much in our element. We were even more at home when a meter was wrecked and when a sizzling corona developed between one end of an inductance and the frame. "Why," we thought, "our own transmitter can do all the things this one can."

An hour or so later the merry whine of the water cooling pump was lost in a sudden report, a flash of flame and a scramble to the switch. We had at last shared in the wrecking of a 10 Kw. "bottle". Could we have wished for a finer thrill? "This is something our own transmitter will never do", we reflected.

New England Division Convention

(Maine Section)

July 13-14, Augusta, Maine

THE Y.M.C.A. is the place where all meetings will be held, except the Banquet, which will take place at the Augusta House. The Committee has prepared a good program and cordially invite all "Hams" in the New England Division to come to Augusta for a real good time and relaxation. Of course, visiting amateurs who might be spending their vacations in the State will receive the glad hand if they show up.

What Is Amateur Radio Traffic?

An Opinion Prepared for the Consideration of the American Radio Relay League Under the Law and Regulations Now Effective

By Paul M. Segal*

The question of the amateur's right to engage in message traffic is an increasingly important one, particularly in these days when our frequencies and our ranges are directly comparable with those of the commercial radio stations which work alongside us. There is a tendency in some quarters to the feeling that it is improper for us to handle messages of any importance, a tendency which, carried to its logical conclusion, would reduce our Communications Department to the same impotent basis as the traffic activities of foreign amateurs where the governments enforce a monopoly on behalf of the state-owned communications. In this article Mr. Segal, the League's General Counsel, analyzes current law and regulations, and gives his opinion on our rights.—Editor.

THERE has been much discussion of what messages and types of messages may be handled by American amateur radio stations. Several attempts have been made under the treaties, the law, regulations and license provisions to set forth more clearly the answers to the questions raised, but as the general questions are answered specific ones arise. An attempt should therefore be made to set forth, as clearly as possible, the law applicable.

Stating the problem in its most general form, we have the following query: What is an amateur message and what are the features or elements which may enter into its source, text or method of handling to deprive it of that classification?

Similar problems have agitated other fields of activity and in many cases with less possibility of solution. In athletics, for example, the opposite of 'amateur' is 'professional' and thousands of agencies over a period of many years have devoted their best efforts to attempts to draw the line of demarcation between the two groups. The distinguishing element there is the question of compensation. Yet even this distinction has become the subject of controversy. A recent example is the quarrel during 1927 between the International Olympic Committee, the *Federation International de Football* and the Football Association of England over the question of whether a football player might accept compensation for the loss of time from his employment during his attendance at the Amsterdam Olympiad. Athletics has never arrived at a plain or universal standard for the solution of the problem and it is still being bitterly agitated. The most that can be said is that an athlete's amateur stand-

ing depends upon the rules of the particular conference or association to which he belongs or in which he desires to compete.

In the radio field one element of complication is eliminated. We have, in this connection, no such thing as an amateur operator status. This is recognized by the law. Under the radio regulations an operator holding a commercial license may—by virtue of that license only—operate an amateur station. Also an amateur operator who, for example, has spent the summer as a ship operator, is not by that fact disqualified as an amateur after the fashion of the college baseball player who has spent a summer playing professional baseball.

In radio there are two opposites to 'amateur': 'non-amateur' and 'commercial'. These two are not mutually exclusive. In using these words we must bear in mind that they are of wide meanings and that one can, in working out the amateur or commercial aspect of a particular fact, give effect to one's preconceived notions by the definition used.

According to Webster's New International Dictionary, an amateur is 'one who is attached to or cultivates a particular pursuit, study or science, as music or painting, from taste, without pursuing it professionally.'

Commercial, by the same authority, is 'of or pertaining to commerce; mercantile; hence, variously: occupied with commerce; engaged in trade.'

From the first of these definitions it would appear that an amateur radio station is one maintained and operated by an amateur as above described which is not used as or as part of the profession or occupation of the amateur. An amateur message would be any message handled by amateurs and amateur stations, regardless of source, text or compensation.

If our inquiry could end here the problem would be easily disposed of, but in radio the

*General Counsel, A.R.R.L.; Director, A.R.R.L. Rocky Mountain Division; 9EEA, Denver.

use of the word 'commercial' instead of the word 'professional', as one of the opposites of 'amateur', introduces further complications.

We meet two tasks. The first is classifying a station either as amateur or non-amateur. This can be done easily by reference to the definition above and the legal definitions which will be given below. If a station is maintained out of taste and not as a business or profession or as part of such, if it is kept up for amusement, for scientific interest, for purely personal aims, it is an amateur station; if it is kept up as a business or profession or for the purpose of assisting in the conduct of a business or for the advertisement thereof or for pecuniary gain, it is non-amateur and has no right to operate under an amateur license, under an amateur call signal or upon any of the wavelength bands set aside for amateur use.

Our second task is that of supplying standards by which we can segregate from this broad amateur field all that in radio can be called 'commercial', such as commercial traffic, commercial correspondence, etcetera. For, even though a station may fall within the classification of an amateur station (as distinguished from what is here called non-amateur), that station cannot lawfully handle commercial correspondence. This second task presents difficulties. But the task must be performed in view of the Revised Regulations Governing the Operation of Amateur Stations (No. 132 Radio Service Bulletin, 12) which provide that 'amateur stations are not authorized to . . . conduct any form of commercial correspondence.'

We must bear in mind that the classes 'commercial' and 'non-amateur' are not mutually exclusive. A station may be both commercial and non-amateur. The station itself may be non-amateur without being commercial. In either event it is not an amateur station, and if licensed as such the law will eliminate it under very simple interpretations. Much greater difficulty arises in the classification of messages as distinguished from the stations which handle them. We must determine whether, for example, a message which does not deal with amateur transmission or stations as its subject matter is for that reason a commercial message. What do the words 'commercial', 'amateur' and 'non-amateur' mean when we apply them to messages?

Aside from the simple dictionary definition of 'commercial' which is given above, it is plain that there are at least four different senses in which the word may be used when applied to radio traffic:

(1) Commercial in the sense that it comes under the protection of the commerce

clause of the Constitution of the United States (Art. I, Sec. 8) which vests in Congress the exclusive right to regulate interstate and foreign commerce. But under such an interpretation all uses of an amateur transmitter constitute commerce [Whitehurst v. Grimes, et al., 21 Fed. (2d) 787; Marconi Wireless Telegraph Company of America v. Commonwealth, 218 Mass. 558, 106 N.E. 310, Ann. Cas. 1916C 214; Sec. 1, Radio Act, 1927]. If such construction were placed upon 'commercial correspondence' the regulation referred to would nullify the law creating amateur stations. Therefore that construction should be disregarded for present purposes.

(2) Commercial in the sense that the text of the message comes within the dictionary definition of 'commercial' given above. Under such a construction an amateur would not be permitted to handle any correspondence relating to barter and trade, to merchandising or commerce. He would be prohibited, for example, from sending over the radio an order for a suit of clothes for himself to a tailor who also had an amateur station but he would be permitted to exact a transmission fee of ten dollars from a sick person for using the radio to summon a physician from a neighboring town. He could place a poster in a lobby of a hotel to the effect that for a flat charge of one dollar per message he would send 'greetings via radio' to anyone in the world but he would not be permitted to send a radio message to a dealer that a rise in the price of fixed condensers was being planned. Any such interpretation of 'commercial correspondence' is illogical. Its legal aspect will be discussed below.

(3) Commercial in the sense that the person whose name is signed to the message receives some gain or benefit from the transmission thereof. Under such a construction, if the person signing the message would have been compelled to use either the wire telegraph, the air mail or simple postage for his message in the absence of an amateur station, the message is commercial because through amateur radio the sender saves ninety, ten or two cents as the case may be. Announcements by radio that the message sender expected to arrive in the addressee's city by a certain train would be forbidden. Most of the messages now generally handled by amateurs would be prohibited. Reducing this theory to its logical extreme, an Official Relay Station of the American Radio Relay League would not be permitted to use his station to rush to the headquarters station, 1MK, a late Section Communications Manager's report for publication in QST because by so doing the amateur saves the S.C.M. the cost of a wire telegram. Such a con-

struction, of course, would place an amateur in a perilous predicament every time a message is tendered either in origination or relaying as its true character depends upon the situation and mental attitude of the signer of the message over whom he has no control and of whom he often has no knowledge. Another objection to this construction is that it would permit amateurs to charge for 'greetings via radio' messages, for certainly, in most instances, such messages can only be sent by amateur radio. It has been suggested that a reason for this construction is that the United States Government, which licenses amateur radio stations, is under a duty to protect the revenue of enfranchised telegraph companies from inroads by amateurs. The mere statement of this proposition, however, is its own refutation. In the first place, wire telegraph companies hold no franchise from the federal government. That government is no more under a duty to protect the revenue of telegraph companies than it is that of railroad companies and if this alleged obligation of protection did exist, it would also be necessary to prohibit automobilists from giving free rides to pedestrians along transcontinental highways. The principal relationship between the federal government and the telegraph companies is this: Congress has the exclusive right to regulate them under their interstate activities and, under the Act of Congress of July 24, 1866, (14 Stat. L. 221, Rev. Stats. Sec. 5263 *et seq.*) guarantees the rights of the companies to construct and maintain telegraph lines along certain roads. Charters and franchises of telegraph companies are derived from the several states. It is not true that the federal government is under any duty to protect an organized business from competition resulting from the progress of science and invention.

(4) Commercial in the sense that the station or operator knowingly and intentionally derives some financial benefit either directly or indirectly from the handling of the message. Such a construction seems to accord with similar language in other connections. An amateur artist paints or draws because he is studying art, because he likes the work as a relaxation, because he wants to amuse himself or his friends. A commercial artist paints a picture because he has been hired to do it and expects to be paid for it. A professional artist derives his livelihood from art. Here is a field in which the three terms 'amateur', 'commercial' and 'professional' may all be used. So also an amateur traveler is traveling because he desires the education and amusement afforded, while the commercial traveler is on the road for a specific purpose because he expects to get paid for it.

Innumerable such examples suggest themselves, such as commercial and amateur 'movies', theatricals, aviation, etc. The world is full of activities which may be pursued either for profit or pleasure and in which the question of remuneration is the sole distinguishing feature between the amateur and the professional or the amateur and the commercial.

If this question of compensation is the true test, there is then a corollary to it. An amateur is free to transmit or not as he sees fit. He accepts nothing for transmitting and cannot be held liable if he fails to perform his promise. A commercial message must be transmitted. There is consideration and a contract. Failure to transmit the paid message to its destination would make the operator liable in damages. There is freedom for an amateur message and compulsion for a commercial message. This being the case, in all instances where there is doubt, under the presently considered definition of 'commercial', this further test may be applied: if the operator is legally free to handle or neglect the message, it is amateur correspondence; if he is under any compulsion to accept the message for transmission or to transmit it after he has accepted it, the message is commercial correspondence.

Having considered these various possible constructions of the expression 'commercial correspondence', the legal provisions in effect may now be examined.

The Radio Act of 1927 (47 U.S.C.A. Secs. 81-120) contains the first statutory reference to amateur stations under that designation. In Section 21 the Act says: 'A permit for construction shall not be required for . . . amateur stations.' In Section 27 it says 'that this section (on secrecy) shall not apply to the receiving, divulging, publishing or utilizing the contents of any radio communication broadcasted or transmitted by amateurs for the use of the general public or relating to ships in distress.'

It will at once be observed that these references attempt neither to authorize nor to define amateur communication. The one section recognizes amateur stations as an already existing type and the other recognizes amateur operators as an already existing class. This indicates the intent of the Radio Act of 1927 to recognize and deal with amateur stations and traffic as those stations existed and as that traffic was conducted at the time the Act was passed (February 23, 1927). At that time amateurs had been existing only by virtue of the Radio Law of 1912 (47 U.S.C.A. Secs. 51-60) and such voluntary rules as they had, through the American Radio Relay League, imposed upon themselves.

The only provision of the 1912 law which

approached a description or definition of an amateur station or its traffic was Regulation Fifteen of Section 4, which provided:

'No private or commercial station not engaged in the transaction of bona fide commercial business by radio communication or in experimentation in connection with the development and manufacture of radio apparatus for commercial purposes shall use a transmitting wavelength exceeding two hundred meters . . . etcetera.'

This language plainly makes the distinction above referred to between amateur and non-amateur stations and is a legal recognition of that distinction. It is true that the Radio Law of 1912 was repealed by Section 39 of the Radio Act of 1927 but the portion quoted must nevertheless be considered in interpreting the latter.

In addition to this provision of the Radio Law of 1912, there were in effect innumerable practices, customs, extra-legal regulations and voluntary restrictions at the time the Radio Act of 1927 was passed. These are properly to be considered in an inquiry as to the significance of the term 'amateur' as used in that Act. By way of illustration, there are the extensive rules of the Communications Department of the American Radio Relay League which were quite generally observed; there are the several types of message blanks prepared by the League and used by its members and containing information for the message-filing and message-receiving public on the type of messages transmitted and the rules of transmission. There are also for consideration the many thousands of messages of all types and character handled for the public each month and the constant emphasis placed upon the fact that these messages were handled absolutely free of all charge whatsoever. Unlimited and conclusive evidence could be adduced to prove beyond any question that at the time of the enactment of the Radio Act of 1927, it was the well established custom of amateur stations to handle messages of all kinds and importance provided only that the handling was without compensation of any kind to the amateur.

As is said in Davis on *Law of Radio Communication*, 28:

'Amateur stations outnumber all other classes in the United States and are scattered over the entire country. Their transmission is chiefly by the telegraphic code, and is carried on for *pleasure and experimentation*. Although these stations constitute in fact a communications system covering the United States, they are *not used for gain*.' (Italics ours)

On November 25, 1927, the International Radiotelegraph Convention was signed at Washington, D. C., after a conference lasting more than six weeks. It was ratified in executive session by the United States Senate on March 21, 1928. It will go into effect and become part of the 'supreme law

of the land' on January 1, 1929. In Article 1 of the General Regulations annexed to the treaty, we find the following language:

The term 'private experimental stations' means:

1. A private station intended for experiments with a view to the development of the radio technique or radio art;
2. A station used by an 'amateur' i.e., by a duly authorized person interested in radio technique solely with a personal aim and without pecuniary interest.

This language unquestionably strengthens the view that the proper construction of the term 'commercial' is that discussed as number (4) above.

In addition, we have the following significant language in Article 6 of these Regulations:

6. (1) The exchange of communications between private experimental stations of different countries shall be forbidden if the Administration of one of the interested countries has given notice of its opposition to the exchange.

(2) When this exchange is permitted the communications must, unless the interested parties have entered into other agreements among themselves, be carried on in plain language and be *limited to messages bearing upon the experiments and to remarks of a private nature for which, by reason of their unimportance, recourse to the public telegraph service might not be warranted.* (Italics ours.)

The use of the italicized language would surely not have been necessary if its effect could have been obtained by the use of a term such as 'commercial correspondence' under the theory of construction number (3) of that expression as above.

On March 7, 1928, the Federal Radio Commission, in General Order Number 24, said:

'For the purpose of clarifying the amateur situation the Federal Radio Commission has adopted the following definition and regulation: an amateur station is a station operated by a person interested in radio technique solely with a personal aim and without pecuniary interest. Amateur licenses will not be issued to stations of other classes.'

This gives present effect, in the United States, to the definition of the Treaty set out above.

On March 6, 1928, the Federal Radio Commission (see No. 132 Radio Service Bulletin, 12) caused to be issued certain Revised Regulations Governing the Operation of Amateur Stations, which provide, after a repetition of the language of General Order Number 24, among other things, that:

'Amateur stations are not permitted to communicate with commercial or Government stations unless authorized by the licensing authority except in an emergency or for testing purposes. This restriction does not apply to communication with small pleasure craft, such as yachts and motor boats, holding limited commercial station licenses which may have difficulty in establishing communication with commercial or Government stations.

'Amateur stations are not authorized to broadcast news, music, lectures, sermons or any form of

entertainment, or to conduct any form of commercial correspondence.' (Italics ours.)

The italicized portion may be the subject of controversy. The Federal Radio Commission has made no explanation of what it means by conducting 'commercial correspondence'. Isolated by itself, without any legal background or context, the expression might fall into any one of the four classes of construction above discussed. In the absence of explanation or further definition by the Commission we have the duty, then, of construing the expression, and in so doing we must bear in mind the following factors:

1. In the first paragraph quoted, the word 'commercial' is used twice as adjective before 'stations' and in the second paragraph once as adjective before 'correspondence'. It is reasonable to assume that it is throughout used in the same sense. As is well known, a commercial station is a station operated as a business for gain or profit.

2. The Regulations repeat the language of General Order Number 24, giving color to the Regulations by the use of the expression 'pecuniary benefit'.

3. In connection with radio communication, as is above set forth, the interpretation of 'commercial' as 'for gain', is the only reasonable one.

4. The language is not framed as though it was intended to destroy an existing custom but rather to prevent the development of a new one and it is found conjunctively with the prohibition of broadcasting of entertainment, an activity in which amateurs have not heretofore engaged.

5. Section 27 of the Radio Act of 1927, in the portion quoted above, dealing with certain exemptions from the secrecy rule, refers to 'radio communication . . . transmitted by amateurs for the use of the general public', clearly recognizing a traffic existing in America by amateurs for the public.

6. The Federal Radio Commission having copied from Article 1 of the General Regulations attached to the treaty, the language of General Order Number 24 and the language of the second paragraph of the Revised Regulations, we must assume that if they had intended to place in effect in the United States the provisions of paragraph (2) of Article 6 of those General Regulations, they would have copied that also, instead of using different terms having a generally accepted and a logical meaning contrary to paragraph (2).

So much, then, for the present situation. AN AMATEUR OPERATOR, AT AN AMATEUR RADIO STATION, MAY, UN-

DER THE LAW, ACCEPT FOR TRANSMISSION, TRANSIT, RELAY OR DELIVER A MESSAGE OF ANY KIND OF TEXT, IMPORTANCE OR SOURCE SO LONG AS NO MONEY OR OTHER VALUABLE CONSIDERATION IS DIRECTLY OR INDIRECTLY PAID OR PROMISED HIM OR CHARGED OR ACCEPTED BY HIM, subject of course to the general laws against obscene or profane language over the air.

The principle can be illustrated by a few cases taken from inquiries received at American Radio Relay League headquarters.

1. Two amateurs, A and B, at cities X and Y, have an operating schedule. Branch offices of the Z corporation are located at each city. A is employed with the Z corporation as a clerk. Subsequent to the employment of A, the branch manager of the Z company discovers the radio connection and asks A to transmit company reports via the radio schedule from X to the branch manager at Y each evening. Under this state of the facts, the amateur would be entitled to handle the traffic. If the manager offered A a weekly increase in salary on condition that A handle this traffic, it would then become commercial correspondence and a violation of the Regulations. If A had originally obtained his clerical position merely because of his radio schedule, with the traffic handling in contemplation, the traffic would likewise be a violation of the Regulations. So also, if, having obtained the position without reference to radio, the handling of the traffic were made a condition of his keeping it. If the manager told A to take time from his clerical duties each afternoon between two and four for traffic handling for the Company, the traffic would be commercial. If the Z Company undertook to furnish A with any of his equipment in consideration of handling traffic for them, the traffic would be commercial.

2. The X Radio Club enters into an arrangement with the Y Hotel that if the hotel will furnish a room for the club meetings, its amateur members will handle radio greetings messages for guests of the hotel free of charge. This is commercial correspondence and prohibited even though the consideration for the traffic goes to the club rather than the individual members and even though the consideration comes from the hotel and not from the guests for whom the messages are handled.

3. Radio station 9UVW is the property of and is maintained by a daily newspaper. It has a daily schedule with station 8WVU which latter station transmits to the paper, free of charge, items of news interest from the city in which it is located. Under these circumstances 8WVU is within the law.

The newspaper station, however, is clearly violating the law. The newspaper station is a non-amateur station. It is maintained with a pecuniary interest, the saving of telegraph tolls and the utilization of the amateur communication system as a news gathering agency for its own benefit. If the newspaper station broadcasts news to the general public instead of collecting it, it is still non-amateur in that it is maintained for the advertisement of the newspaper and its consequent financial benefit [see *Jerome K. Remick and Company v. American Automobile Accessories Company*, 5 Fed. (2d) 411].

4. The X Radio Club places a poster at an automobile tourist camp ground reciting that all desiring to send radio messages may do so free of charge from the stations of the club members. This is lawful.

In closing, some speculation might be indulged in as to the right of the Federal Radio Commission, should it so desire, to amend the Regulation quoted and attempt to put into effect, for American amateur communication, the drastic rule which will be made internationally effective under General Regulation 6 (2) quoted above in an effort to prevent amateurs from handling messages otherwise important enough to go over the line telegraph. The right of the Federal Radio Commission to enact such a rule is, to say the least, very doubtful.

Section 4 of the Radio Act of 1927 provides as follows:

"Sec. 4. Except as otherwise provided in this Act, the commission, from time to time, as public convenience, interest or necessity requires, shall—

(h) Prescribe the nature of the service to be rendered by each class of licensed stations and each station within any class."

This and similar language elsewhere in the Act requires the order of the Commission in any such connection to be made in the public convenience, interest and necessity. A regulation like 6 (2) which would have the effect of emasculating the amateur system and crippling the development of the amateur art merely to prevent a very doubtful competition with telegraph companies could hardly be sustained as being in the public interest, convenience and necessity.

Again, an amateur undoubtedly has a valuable property right in the station he owns and in his right to continue in the use thereof. This right not only entitles him to the use of the station as a personal convenience but also to give away certain of the benefits accruing from the ownership of the station. The attempt to divest that right by a regulation not of a police

character, not closely allied with the public safety, health or morals and not even tending to any public good in its reasonable consequences, would very probably be held to violate the Constitution of the United States.

But these are questions not for the present, and, it is to be hoped, not to be raised in the future.

Vanalta Division Convention

July 28-29, Vancouver, B. C.

HAIL to the "gang"! For the third time, we, the B. C. Amateur Radio Association, are going to stage the annual A.R.R.L. Convention and extend to all radio amateurs a cordial invitation to attend our affair.

A good program has been prepared, and we now have our own club house to help entertain visitors.

Ed. S. Brooks says there is only one thing to do to make him feel good as the Secretary of the Association and that is to drop him a card saying you will be there. His address is, Radio Room, Court House, Vancouver, B. C.

Strays

The list of 'Amateur Radio Stations of the United States', published annually by the Government Printing Office at Washington, is now promised to be available in adequate quantities in subsequent issues. In past issues the supply generally has been exhausted a few months after appearance.

Word was generally distributed some months ago that the supply of the last edition, dated June 1927, was exhausted. This now proves incorrect, the supply merely having been mislaid during a movement to new quarters, and at last reports 600 copies were available. This list is accurate to its date, and inexpensive. Copies may be had at 25c each (stamps not accepted) from the Superintendent of Documents.



1XV-1XAN*

An Experimental Station with the World as Its Laboratory

By Gordon G. Macintosh†

The Kennelly-Heaviside layer (if any) and the routing of short-wave signals hold few secrets for 1XV-1XAN at which station some of the experimental work conducted formed the basis of that brilliant treatment of antenna problems 'Directional Properties of Transmitting and Receiving Antennae' which appeared in the March, 1928, QST.—Editor.

THIS station is sponsored by Col. E.H.R. Green, who has provided the means and facilities for short-wave radio experimentation under the supervision of the Electrical Engineering Department, Communications Division, of the Massachusetts Institute of Technology, and is located on his beautiful Round Hill estate at South Dartmouth, Massachusetts.

Should we journey seven miles down the Atlantic coast from New Bedford, enjoying the country scenery and the fresh sea

the big stone mansion with the lawns, greenhouses, windmills, the farm, the duck pond, two sets of radio towers high in the air, the 'lighthouse' containing the public address installation, and the whaling ship 'Charles W. Morgan.' Anchor chains mark the edge of the roadway while large anchors of ships that have passed on forever, greet us at the forks of the roads. The towers near the mansion support the antenna for the broadcasting station, WMAF, where Mr. Shirley L. Davis, better

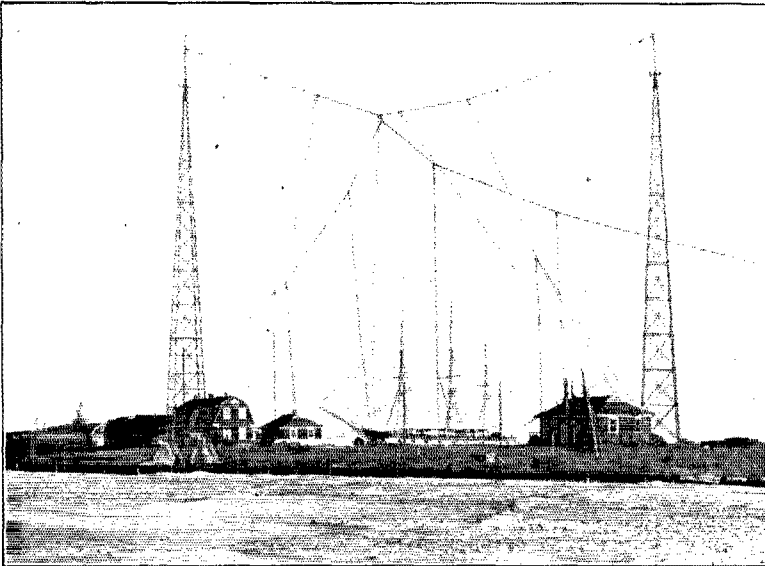

VERTICAL DOUBLETS SWING WHERE ONCE DOUBLOONS WERE BURIED

A general view of the station and antenna systems. Suspended between the two masts is the system shown in Fig. 22 on page 24 of the March QST with the difference that four vertical wires are used instead of the eight shown on the diagram. Many other vertical voltage feed antennas are sprinkled over the landscape.

air, we would find ourselves at the entrance of Round Hills. A half mile further and we would be in sight of the ocean again and

*Contribution from the Colonel E.H.R. Green Shortwave Radio Research.

†Resident Operator.

known in our circles as 1BHS, holds forth. Inside the station, a complete Western Electric 1-Kw. transmitter is installed along with a public address system that provides entertainment during the summer months to hundreds of visiting motorists,

through the large group of loudspeakers mounted at the lighthouse.

Let us continue another half mile down towards the beach and we arrive at our real destination. The ocean waves are

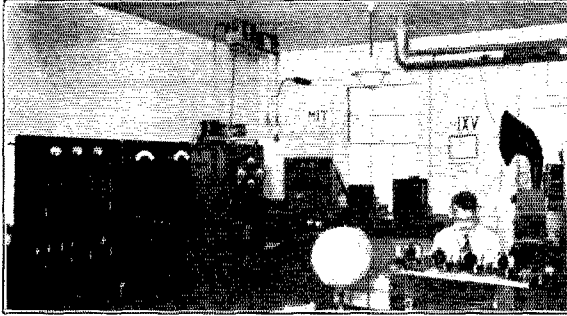

WHERE HIGH-FLUNG THEORIES COME TO EARTH

The operating room of 1XV-1XAN as seen on entering the station. From left to right can be seen the short-wave power distribution board, broadcast transmitter power board, broadcast transmitter with 50-watt 60-meter transmitter on top, the 'flexible' transmitters, the 50-watt, 20-meter and 250-watt, 40-meter transmitters. At the right are the broadcast speech input equipment, short-wave receivers and wavemeter and, in front, the 30 Kc. intermediate frequency amplifier of the short-wave super. The author is holding down the key (and the chair).

splashing within fifty feet of 1XV and we are, truly, on the sandy beach. Looking towards the ocean, a group of the Elizabeth Islands, including the well known Cuttyhunk, is visible on the horizon. To our left, Buzzards Bay, where once the New Bedford whalers passed on their way to the sea. The last of the old whaling ships, the *Charles W. Morgan*, lies enshrined in a bed of sand almost within the shadow of our steel towers. A monument to the days of wooden ships and iron men. (They didn't have radio).

The building wherein we find 1XV has three rooms; a studio, an operating room and a generator room, and still houses the original WMAF broadcasting station, a Western Electric 2A, 100-watt transmitter, complete.

Now that we are familiar with the surroundings, let us enter the operating room, shown in the photograph exactly as we see the room on entering. From left to right are two power control panels convenient to the operator, followed by the 2A broadcast transmitter. The flexible transmitter described in November, 1926, *QST*, may be seen to the left on the rear table alongside of which are two transmitters in panel form. One is designed for 20 meters using a 50-watt tube, the other for 38 meters using a UV-204-A. Far back in the corner, barely visible, is a 20-meter breadboard set employing a UV-204-A. Some of the trans-

mitters are designed in panel form for semi-permanent installation, while others are breadboard arrangements to facilitate experimentation.

One of the photographs shows the rear view of the UV-204-A, 250-watt, panel-type transmitter. Four tuning controls on the front provide ease of adjustment. Two condensers are used for antenna tuning, while the others are oscillator tank circuit and grid condensers. Inductances and other equipment are mounted on the rear framework, as shown in the photograph. The coils are mounted on a small wooden base which may be slid into place between wooden guide rails, thus permitting quick change of the inductances and adjustment of coupling. Power and keying leads are brought to the rear and terminate in binding posts. The advantages of this type of transmitter arrangement include ease and permanence of adjustment to any desired wave band; ready accessibility of parts, short solidly-supported leads, combined with a neat appearance and reasonable cost.

Next we see the back of the operating desk. To the left of the operator is the Western Electric electric speech input equipment, part of the original WMAF station. Three plug-in coil receivers, on the desk, cover wavelengths from 15 to 200 meters and may be used with or without a superhetero-

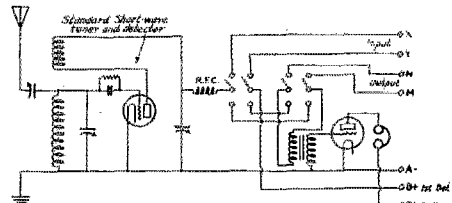

FIG. 1. THE STANDARD SHORT-WAVE RECEIVER WITH CHANGE-OVER SWITCHES

The detector and one-step is similar in lay-out and constants to ordinary receivers used by thousands of amateurs. This diagram is given to show the arrangement of the switches used to change the output of the detector from the audio amplifier to the intermediate amplifier when the super-heterodyne is to be used, and to hitch the output of the intermediate and second detector to the audio tube.

dyne amplifier shown directly in front of the operator. Two and sometimes three receivers are used simultaneously for multiplex reception as suggested by J. K. Clapp in *QST* for March, 1926. Motor generator controls are mounted conveniently at the operator's left.

It was felt that more sensitive receiving equipment was necessary, and for that reason the superheterodyne unit was constructed to be used in conjunction with the receivers mentioned. After considerable experimentation in the Communication Laboratories of the Massachusetts Institute of Technology, the breadboard model, shown in front of the operator, was decided upon and has been used during the past year. The output of the first autodyne detector is transferred to a filter and three stages of tuned and neutralized transformer-coupled radio frequency amplification, by merely throwing a double pole switch. The intermediate amplifier was tuned to 30 Kc., using fixed capacities across the secondaries of the specially designed transformers, and will only pass signals that are within one kilocycle of 30 Kc. That is, the amplifier will pass a band of frequencies approximately two Kc. wide. The output of this amplifier is connected to a second detector employing plate rectification and back to the single audio stage in the receiver, by way of a second double-pole double-throw switch. By throwing the switches one way, we have an ordinary detector and one stage receiver; switching to the other side we have the superheterodyne arrangement. An oscillator is connected in the grid circuit of the second

The room on the right of the operating room (as seen in the photograph) was originally the studio but is now used for an experimental laboratory which at the moment contains 20- and 40-meter trans-

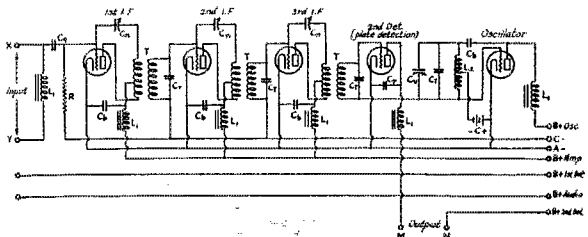
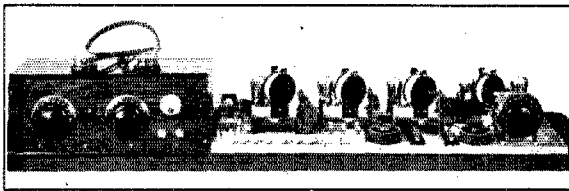

FIG. 2. THE INTERMEDIATE FREQUENCY AMPLIFIER, 2ND. DETECTOR AND LONG-WAVE HETERO-DYNE OSCILLATOR

- T-30 Kc. transformers. Primary, 500 turns of No. 30 wire center-tapped wound outside secondary. Secondary, 1000 turns of same wire. Formers 4" outside diameter, 3/4" wire slot.
 - Cn—10-µmfd. variable neutralizing condensers.
 - Ct—Approximately 6000 µmfd. (several small condensers in parallel used to tune to 30 Kc.)
 - L1—3-Henry Samson chokes.
 - Cg—2000-µmfd. fixed condenser.
 - R—1 megohm.
 - Cb—1-µmfd. fixed condensers.
 - Cp—2000-µmfd. fixed condensers.
 - L2—Oscillator coil with windings same as transformers.
 - W—Windings connected in series, junction used as center-tap.
 - Cy—250-µmfd. variable condenser.
- When set up for operation jumpers are run between the terminals X, Y, M and N shown on the diagram to the terminals similarly designated on Fig 1.

mitters, broadcast receiving equipment and various other pieces of apparatus that one finds in a laboratory. The walls are shielded and provided with a special sound-proof covering, in order to make the room suitable for use as a studio.

To the left of the operating room is the generator room. Two complete motor-generator units, mounted on concrete bases, supply the power to transmitters throughout the station. For plate voltages below a thousand volts, a Robbins and Meyers unit, consisting of a one-half Kw. generator and a filament generator, both driven by a Wagner 2 h.p. motor, is used. For higher plate voltages, an Esco unit is used which consists of a 3,000-volt, one and one-half Kw. generator and a 15-volt, one-half Kw. generator. This unit is driven by a Wagner 5 h.p. motor. Another small Esco motor generator is used for field excitation. Along the rear wall a bench extends from side to side. At present an 80-meter transmitter is installed here, with ample room for others. A work bench, rows of shelves for storing extra equipment, a 10-amp. Tungar charger, Willard storage 'B' bat-



THE SHORT-WAVE SUPER-HETERODYNE RECEIVER

The 30 Kc. tuned and neutralized transformer-coupled amplifier follows the standard short-wave receiver at the left. Either the usual two-tube receiver or the complete super may be placed in operation by throwing two switches. A screen-grid amplifier has been built for the work (and rebuilt three times) but it has not yet proved the equal of the outfit here shown.

detector for the reception of c.w. signals. All battery leads have chokes and by-pass condensers to prevent interaction of the circuits. For the entertainment of visitors, the output of this super is sometimes connected to the speech amplifier equipment and DX signals amplified a la R-50 or so. This superheterodyne has also successfully operated tape recorders on many DX stations.

teries, Exide 'A' batteries and a high voltage power transformer for use when a.c. is required, complete the power room equipment.

Leads from the generators go directly to the power panels in the operating room, shown in the left of the photograph. Double-pole single-throw switches provide means for transferring power to any one

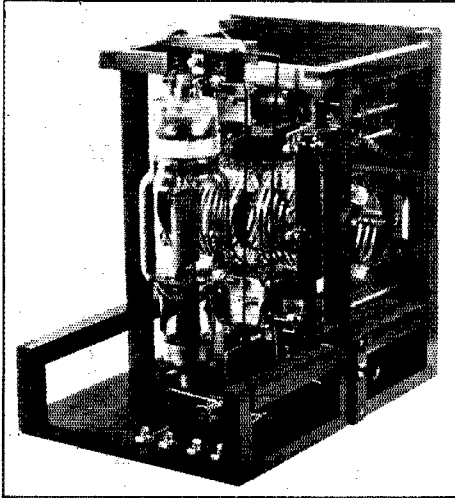

A TYPICAL TRANSMITTER RIG

Rear view of the 250-watt, 40-meter transmitter. The coil at the left with variable condensers above and below it constitutes the antenna tuning and coupling system. The coil at the right with the variable condenser below it comprises the oscillator circuit. Above it is the variable grid condenser.

or all of the transmitter benches located in the three rooms. Three meters at the top of the power panel are in sight of the operator at all times, and thus the filament voltage, plate voltage and current are always known, although the transmitter in use may not be within sight of the operator. Individual power switches are mounted on each transmitter bench in each of the three rooms and wiring brought to binding posts conveniently located. Therefore, if we have three transmitters on a single bench and wish, for instance, to operate two of them simultaneously, all that is necessary is to adjust the power panel switches for the particular room and close the bench switches for the desired sets.

The Hartley circuit is used in nearly all cases in transmitters using UX-210, UX-852, UV-203-A and UV-204-A tubes. Communications are carried on with various power inputs from 10 to 1,000 watts, on frequencies from 3,000 to 100,000 Kc.

Vertical half-wave antennas, fed by two-wire voltage-feed lines, either one quarter or three quarters wavelength long, are used almost entirely for average communications. After considerable research, this type of antenna has been selected for its general adaptability and consistent performance. Solid copper enameled wire is used for both antenna and feeders. Feeder lines are separated by wooden dowels boiled in paraffin.

Experimental work at this station has consisted of: (1) the development and extended operation of short-wave receiving and transmitting equipment; (2) a study of the variation of the cut-off wavelength (the minimum wavelength at which signals are audible for a given distance) for different times of day and seasons of the year, mainly between 1BYX and this station; (3) a study of fading on various wavelengths; (4) a study of the 38-meter transmissions to points throughout the world, during a period of two years, which permitted the plotting of skip-distance maps for various times of day and night and seasons of the year; (5) the compiling of reports of foreign signals, their time, date and wavelength as they are received at this station; (6) a study of practically all types of antennas employed for short-wave transmissions, including small directive (beam) systems; (7) a study of the variation of signal strength at the receiver as the direction of the transmitting antenna is changed in space, and (8) a study of the radiating characteristics of 3-meter antennas.

Whenever research activities of the station permit, the station is always glad to communicate with amateur stations in any part of the world, and is particularly glad to receive reports on the reception of its signals. All communications will be answered. In times of emergency, or in times when the need for special communication is urgent, the station is glad to offer its facilities and to be of any assistance possible. Communication with various expeditions, and with stations located at outlying points of civilization, has been maintained in many instances in the past, and the station is always interested in being of assistance in such cases.

The technical work of the research is under the direction of J. K. Clapp (1BYX-1BJN), of the Electrical Engineering Department, M. I. T.; Howard A. Chinn and Lloyd T. Goldsmith, of the same department, are in charge of the laboratory and field investigations.

A Phone Transmitter for the Beginner or Advanced Amateur

By R. Wm. Tanner*

AMONG the amateur fraternity, the radio phone is the cause of a lot of argument. Some think that it is of no use at all while others agree that a good phone is decidedly worthwhile. There are few, if any, real good amateur phones. The reason for this is due, mainly, to the use of an unstable oscillator coupled closely to the antenna and modulation accomplished by either loop or the constant-current system. The loop is out of the question if quality is considered. It is also a "HAM" way of doing the thing. Constant current modulation varies the voltage to the plate of the oscillator and shifts the frequency at which the circuit is oscillating in a manner similar to an unsteady plate supply. The only difference being that the variation is at speech frequencies rather than just the supply frequency. The result is broad tuning and lots of interference in the immediate vicinity. Another "red mark" against the phones is the use of a plate supply that contains a large percentage of a.c. hum. Who wants to strain their ears trying to pick out a few words all garbled up with 120-cycle a.c.

Let us see what constitutes a good amateur phone. It means, first, a carrier wave that is absolutely steady. Second, that the a.c. or commutator hum in the plate supply is weak or practically non-existent when the microphone is not being actuated. Third, undistorted speech. I might mention more but these are the main points to watch.

Crystal control gives a 100 percent steady signal but is inflexible as to the shifting of frequency. An oscillator with a large capacity across the tube elements together with a fairly high grid leak resistance followed by a neutralized amplifier will emit a good steady signal. While not as steady as a crystal it will answer the purpose.

A filter containing two 30-henry chokes and about 10 μ d. of shunt capacity, properly placed, will not pass enough of the a.c. component to be noticeable.

Modulating on the grid of the P.A. together with a speech amplifier using a good reliable make of audio transformer and sufficient grid bias will not give any trouble in obtaining undistorted speech. This form of modulation is shown in Fig. 1. The one requirement of the speech am-

plifier is that sufficient voltage is available from transformer coupling the 171 to the r.f. amplifier. Modulation is accomplished by varying the bias on the power amplifier tube in accordance with the speech input. This should not be confused with similar

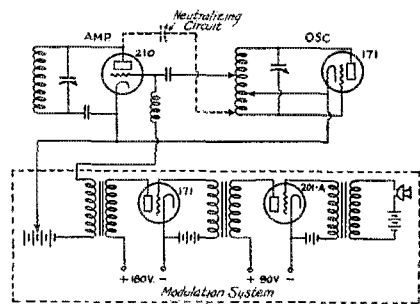

FIG 1

THE ESSENTIALS OF THE CIRCUIT

The modulator portion may be borrowed from a good BC receiver. The transformer in the plate circuit of the 171 may be any of a number of good output transformers designed to couple the 171 to a loud speaker.

modulation applied to an oscillating tube. There is not anything near a linear relation between output and grid bias in an oscillating tube circuit, whereas there is a thoroughly satisfactory relation between them in an amplifier circuit.

Now that we know what is required for good phone transmission, let us construct one built around these ideas. Fig. 2 shows the complete circuit. There are four tubes in all, a UX-210 as power amplifier, a UX-171 as oscillator and a UX-171 and UX-201-A as speech amplifiers. The last audio amplifier may be a UX-112 if desired as the output voltage will probably be high enough to swing the grid of the 210.

OSCILLATOR

It will be noticed that the oscillator circuit is a shunt feed Hartley. This was chosen for no reason other than the fact that it oscillates easily and is very simple to put into operation. With proper adjustment, a UX-171 will furnish sufficient excitation to the grid's of two 210s as power amplifiers (if two are desired for greater output). However, do not make the mistake of overloading this circuit or

*ex-1BZY 8CMU, 1720 Delaware St., Berkeley, Cal.

absorbing too much energy from it or it will become unstable. There is little sense in having a master oscillator if it is at all unstable.

It is well to use a large value of shunt capacity and a small number of turns in the tuned circuit. The output is then not so much affected by variations in plate or filament voltages. For operation in the 85-meter band, the tuning inductance consists of 8 turns of No. 12 enameled aerial wire space wound and held together with strips of celluloid and colodion. The diameter is 3". This method of winding has been mentioned in *QST* before so there is no need of saying any more¹. A tap is taken off at the center for connection to the filament. The tuning condenser is shunted across all of the inductance (from grid to plate) and has a capacity of .001 μ f. The grid condenser is .0005 μ f. and is shunted by a 10,000-ohm grid leak. The plate blocking condenser has a capacity of .001 μ f. An r.f. choke is connected next to the plate and consists of 300 turns of No. 34 cotton covered wire on a 1" form. The first 100 turns are spaced, then 100 close wound and the remaining 100 scramble wound. This enables the choke to be used down to about 20 meters with small loss at all waves.² To keep the plate voltage at exactly 180, two of the R.C.A. glow tubes may be connected in series and placed across the plate supply. However, this is not absolutely. The 180 volts is obtained from the high voltage supply through a resistance. The filament is lighted from a storage battery.

THE POWER AMPLIFIER

This circuit must be free from bad wiring, high resistance and poor insulation. The exciting voltage for the grid is obtained by taking an inductive drop across part of the oscillator coil. The number of turns is not especially critical so the grid connection may be made directly to the plate end of the oscillator inductance. The plate coil for 3500 Kcs. (85 meters) has 11 turns of No. 12 on a 3" form with the turns spaced as in the oscillator coil. For 1875 Kcs. (160 meters), this should have 20 turns. An r.f. choke is placed in the positive high voltage lead close to the plate coil but not too close. This choke is a duplicate of the one in the oscillator. The plate coil is tuned by means of a .00025- μ f. condenser. The filament voltmeter has a range of 0 to 10 volts. A milliammeter is connected next to the r.f. choke.

1. See page 34 of the June, 1928 and 16 of the November, 1927 issues of *QST*.—Ed.

2. Such a choke will give fair action over a broad band. For good choking over a narrow band, the type described on page 27 of the October, 1927 issue is recommended.—Ed.

This has a range of 0 to 50 m.a. The meter is mounted on the panel with a piece of two-wire lamp cord attached to the terminals. On the end of this cord is a telephone plug. The plate circuits of all of the tubes, except the first speech amplifier, contain a closed circuit jack. This makes it possible to read the plate current of each tube. If two tubes are used in the power amplifier, a resistance should be connected across the jack in that circuit as the current here will some times run as high as 80 mills. The resistance should be of such a value as to give a full scale reading when the current is 100 mills. The manufacturer will furnish the resistance at a nominal price. A small size 45-volt "B" battery is used to supply the grid bias and must be variable in small steps. About the best way to vary the voltage is to use a high resistance potentiometer. A Frost 50000-ohm affair will be about right. The adjustment of the grid bias will be taken up later. The secondary of the last audio transformer, in the speech amplifier circuit, is connected between the negative of the grid battery and the r.f. choke.

THE ANTENNA CIRCUIT

The antenna coil has 8 turns of No. 12 wire 3" in diameter. Coupling to the amplifier plate coil is variable up to about 3" which is sufficient. A radio frequency ammeter may be used if desired to show the antenna current but is not necessary. If one is to be built into the set it should have a range of 0 to 1 or 2 amps. A .00025- μ f. variable condenser is connected in the antenna lead to tune this P. being power, E. voltage and I current.

SPEECH AMPLIFIER

This part of the transmitter is merely a good audio amplifier with a power tube in the last stage. The quality depends, a great deal, upon the type of coupling transformers. Do not make the mistake of building a phone transmitter of this type and then installing a set of \$2 transformers. The result will surely be rotten quality. Hundreds of broadcast listeners are now listening in on the short waves and you may be received by some of them. After listening to good quality from the B.C. stations for the past few years, any amateur station sounding as if the operator had marbles in his mouth, would be in for a nice razzing. Fellows, if you would only get that a.c. out of your signal and build a good speech amplifier, you would receive a great many cards from the short-wave BCL's saying that they heard your "program" or "broadcasting" (they call all transmitting broadcasting). Usually these BCL's are truthful. If they say you are

loud and the quality is good, you may be sure that they have spoken the truth (which is more than can be said of a lot of amateurs).

But to get back to the story. Three transformers are required. Silver-Marshall type 220s are used throughout although there are a few others that will answer as well. One of the 220s is used as a modulation transformer with a Baldwin type C headphone as a microphone connected in the primary. This gives much better quality than a regular carbon grain type. A 22.5-volt battery, in series with the 'microphone' is not always necessary. First try to work without it, then connect it in the circuit. Whichever way works the better is the one to use. One quarter megohm grid leaks are connected across the secondaries of the first two transformers.

The bias on the first stage is 4.5 volts and on the last, 40 volts. It should be obtained from batteries rather than from resistances in the 'B' supply. The filament of the 171 tube is lighted from a 5-volt winding on the power transformer. It may be lighted from a storage battery as is the 201-A filament.

It is a good plan to place a milliammeter in the plate circuit of the 171. It should have a range of 0 to 25 M.A. If the reading deviates from normal when talking, distortion is present and speech input should be reduced. All of the speech amplifier parts are mounted in a separate cabinet and placed near the receiver.

FILAMENT AND PLATE SUPPLY

A transformer, rectifier and filter furnishes the plate and filament voltages. Only 8 rectifier jars are needed with a 1/2 megohm resistance shunted across each cell. This was described on page 44 of the December, 1927 issue of QST. These resistances should not be left out as they are the secret of non-heating chemical rectifiers. The transformer primary is tapped to make up for any variation in the 110-volt line. This coil is wound on a fiber or bakelite tube 2 1/4" in diameter and 6" long. It consists of 239 turns of No. 16 enamel wire tapped at 203, 209, 215, 219, 223, 229, 235 and 239 turns. This takes care of any voltage between 102 and 120. A layer or two of heavy paper is placed over the primary and the filament windings of 16 turns of No. 12 d.c.c. and 11 turns of No. 16 d.c.c. for 7.5 and 5 volts respectively are wound on. Three or four layers of paper are put over this and then the high voltage secondary is wound on in two equal sections of 1200 turns each. No. 20 d.c.c. wire is used. The outside lead of one section is connected to the inside of the other, which becomes the center tap for full-wave rec-

tification. After all of the coils are wound, the entire unit should be well tapped. The core is made up of a bundle of stove pipe iron wire about 2" in diameter or just large enough to fit tightly into the

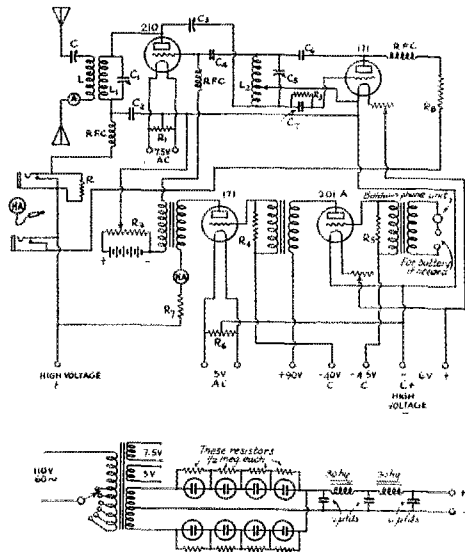

FIG. 2

THE COMPLETE CIRCUIT WITH ALL THE NECESSARY RESISTORS, METERS, ETCETERA

The filaments of the master oscillator and first audio tubes are supplied from a 60-volt storage battery. The other two filaments are operated from the power transformer. The constants are as follows.

- C, C1—250-μufd. variable receiving condenser.
- C2, C6—1,000-μufd. fixed condenser.
- C3—Neutralizing condenser, 50 μufds.
- C4, C7—500-μufd. fixed condenser.
- R—Meter shunt to give double range.
- R1, R6—200-ohm potentionmeter.
- R2—Frost 50,000-ohm potentionmeter.
- R3—10,000 ohms.
- R4, R5—1/4-megohm leaks.
- R7, R8—Heavy duty type Clarostat.

fiber tube. The iron wires should be cut long enough so that they may be bent up over the top of the windings from both ends and overlap about 2". At the overlap, the wires should be taped very tightly to avoid vibrating at the frequency of the supply voltage. Just a word of caution here; mark all leads with a tag during the coil winding process. After the transformer is completed, it may be mounted in a wooden box with a bakelite or hard rubber panel on which is mounted the primary rotary switch and terminals. The box may then be filled with wax taken from defunct 'B' batteries and dry cells. In mounting the switch, drill holes for 15 contacts. The primary leads are connected to the 1st, 3rd, 5th, 7th, 9th, 11th, 13th and

15th contacts. This leaves a dead contact between any two live ones.

The rectifier jars may be common jelly glasses with a lead and an aluminum electrode to each jar. A saturated solution of 20 Mule Team borax is used for the electrolyte. So much has been written in regard to chemical rectifiers that I need say no more.

The filter chokes are each of 30 henries and consist of 8000 turns of No. 28 enamel wire on an iron core with a cross section of 1" by 1". An air gap of approximately 1" is required to prevent saturation of the core.³ The shunt condensers are connected as shown in the diagram.

MOUNTING

The oscillator and power amplifier are mounted on a board in the usual bread-board fashion. The amplifier plate coil and the oscillator coil should be separated about 10" or 12" so that it will be possible to neutralize the plate-grid capacity of the amplifier tube. Be sure and place the r.f. chokes so that their fields will not thread through the fields of the inductances. It is a good plan, when wiring, to use flexible wire for the filament circuits and run these under the baseboard. The power transformer, rectifier and filter are mounted on a board placed under the table away from both the receiver and transmitter.

As every amateur has his (or her) own ideas in regard to mounting apparatus nothing more will be said.

TUNING AND OPERATION

First the power amplifier must be neutralized. Place the amplifier and oscillator tubes in their respective sockets. Make all of the connections EXCEPT the positive of the high voltage going to the power amplifier. Place a 2.5-volt flashlight bulb in series with one turn of wire about 3" in diameter close to the plate end of the amplifier plate coil. Light the tubes and set the oscillator at about 3500 Kcs. (85) or 1875 Kcs. (160 meters) depending upon which frequency is to be used. Then adjust the amplifier tuning condenser until the bulb lights. Now adjust the neutralizing condenser until the bulb goes out. Proper adjustment has been found when the bulb does not light at any setting of the amplifier tuning condenser. The high voltage may now be connected to the power amplifier and the antenna tuned to resonance. These adjustments should be made with about a 35-volt grid bias on the amplifier.

When the r.f. end is perking properly, the speech amplifier may be connected and the P.A. grid bias adjusted. In doing this,

3. See the Radio Amateur's Handbook for full data on the design and construction of filter chokes.

the bias battery should be reduced in small steps, with the microphone idle, until the antenna current change with additional reduction is small. Then set the bias at a value which gives a plate current half than obtained at the point of maximum antenna current. When this adjustment is correct, the modulation should be symmetrical.

A short description of the antenna which was used for both the 3500 Kc. (85) and 1875 Kc. (160-meter) frequencies will not be amiss. This was a single No. 14 enamel wire with a total length of 89 feet from the set. It had a height of approximately 40 feet. The counterpoise was also a single wire about 80 feet long and about 7 feet from the ground. The insulation was far from being ideal. Two glass receiving insulators were placed at the ends of the antenna and counterpoise.

This set was designed for operation in the two upper bands but may be used in all of the bands if plug-in coils are provided for. It is very easy to devise a mounting that permits of quick change.

Strays

He: "You say you don't like operettas because they're too fresh—do you know what I'm talking about?"

She: "Sure—amateur radio operettas."
—Idea stolen from *Judge*

It has been estimated that the expenditure on QSL card postage by the world's amateurs last year reached the amazing total of 973,777,000,000 roubles. Of this total just 324,333,333,000 rupees were donated unnecessarily to the various postal authorities by amateurs unaware of the correct rates. Then, to the accompaniment of much teeth-grashing, no less than 325,371,000,003 pfenniges were paid out by recipients of cards sent with insufficient postage.

It is with the hope of relieving this unfortunate (but unconfirmed) condition that we present the following list of correct postal rates:

1c Government postal card alone for U. S., Alaska, Canal Zone, Hawaii, Porto Rico, Philippines, Virgin Islands.

1c card and additional 1c postage for South American Countries, Canada, Cuba, England, Mexico, New Zealand, Spain.

1c card and additional 2c postage for delivery to any other part of the world.

Private mailing cards, or cards other than the 1c government postal card, require a basic rate of 2c instead of 1c. The additional postage required for foreign countries is the same.

Notes on Filter Circuit Design

By D. E. Replogle* and James Millent†

This article constitutes the fifth and last of a series that have appeared in *QST* covering the design of filter systems employed in A and B battery substitutes or similar devices. The initial article appeared in the September, 1927, issue and the following three followed in the February, April and May issues of 1928. They are the result of a great deal of development work on the part of the members of the Rathcon organization.—Editor.

IN previous articles, the writers have described the effect of variations in the capacities of the three filter condensers in a double section filter, C_1 , C_2 and C_3 in Fig. 1. By means of curves, the effects upon ripple suppression of different values of C_1 , C_2 and C_3 were shown, in addition to their effect upon voltage regulation and audio tone quality.

It is the purpose of this paper to present some curves and notes to show the effect upon ripple suppression of variations in

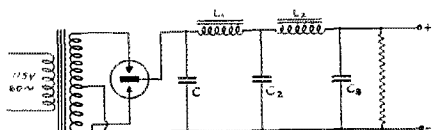

FIG. 1

the inductances of the filter reactors L_1 and L_2 , with different values of C_1 . Thus, a power unit or electrical set designer, knowing just what ripple he can tolerate in the output of his device, may, from a careful study of the various curves in this and the preceding articles, select the values of inductances and capacities that will most economically give the desired degree of filtration.

Then, by means of the article in the April, 1928, issue, on the design of filter reactors that carry direct current, the design of choke coils having the desired inductance under the working d.c. load, may readily be arrived at. Thus, it is possible to work out on paper the design of a power unit and its component parts so as to secure any desired degree of filtration. Furthermore, experience has shown that power units designed in this manner, when actually constructed, will give the desired performance to within a very close degree.

But let us refer to the curves. In Fig. 3 is shown the effect of variations of L_1 , for six different values of C_1 , while L_2 is held constant at 20 henries. From these

curves, it will readily be seen that the ripple voltage rapidly decreases as L_1 is increased until L_1 is about 20 henries. Above 20

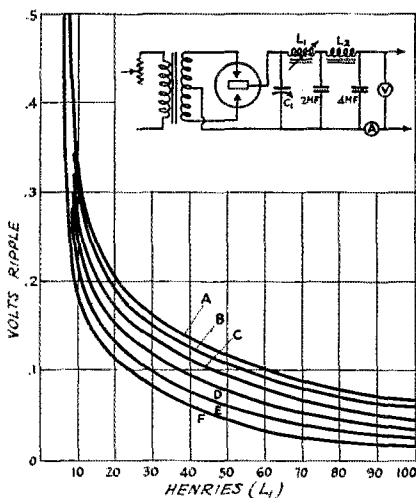

FIG. 2. THE EFFECT ON THE OUTPUT RIPPLE OF THE VALUE OF L_1 WITH VARIOUS CAPACITIES C_1

L_2 in all cases is 10 henries. Curve A is without any capacity at C_1 while the capacity for B is .5 μ f.; for C, 1 μ f.; for D, 2; for E, 3 and for F the capacity is 4 μ f. In these measurements the load current was kept constant at 40 ma. The output voltage was also held constant at 220 volts by varying the input to the anodes.

henries, the decrease in ripple is not as rapid, but still quite appreciable until L_1 reaches a value of about 75 henries. Further increase in the inductance of L_1 above 75 henries results in very little additional improvement.

When L_2 is increased from 20 to 30 henries, as in Fig. 4, the ripple voltage for the same value of L_1 , as in Fig. 3, is very much less. Thus it will generally be found worthwhile where only a very low value of ripple voltage is allowable, to employ a choke at L_2 , having an inductance of more than 20 henries.

The value of increasing L_2 above 20 henries is well illustrated in the instance

*Director, Rathcon Circuit Laboratories, Rathcon Mfg. Co., Cambridge, Mass.
 †Consulting Engineer, 61 Sherman St., Malden, Mass.

where L_1 is 30 henries and L_2 20 henries, as in Fig. 3. The ripple voltage is .09 volts. Where the position of the chokes is interchanged, as in Fig. 4, where L_1 is 20 henries and L_2 30 henries, the ripple voltage is only .04 volts or less than half as much. Therefore, it will readily be seen that the arrangement of the various chokes and condensers must carefully be considered where the best of performance from a minimum amount of material is essential.

Perhaps it is in this connection that the curves and data given in this series of articles on filter design will prove most valuable to the amateur who has a given set of choke coils and condensers on hand from which he desires to obtain maximum performance.

In many instances, where a very low ripple value is not essential, single section filters may be more economical than the more conventional double section type with

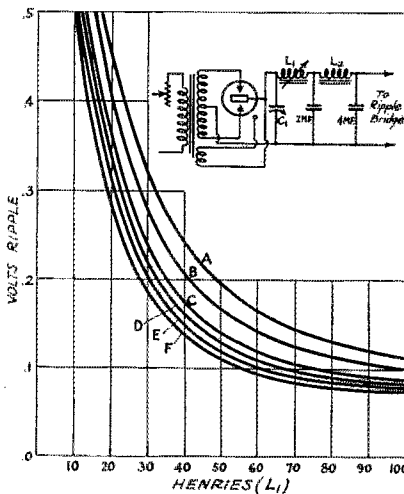

FIG. 3. EFFECT ON THE OUTPUT RIPPLE UNDER SIMILAR CONDITIONS AS IN FIGURE 2 EXCEPT THAT L_2 IS 20 HENRIES

which we have been dealing. In Fig. 5 are a series of curves showing the performance of a single section filter as the inductance L_1 is varied for different values of C_1 . A filter of this type is generally suitable for use with c.w. transmitters that are not to be used for phone work.

The output condenser, C_2 in Fig. 5, was given a value of 4 μ fd. A smaller value will generally prove unsatisfactory at this point for the reasons already discussed in the special article dealing especially with the function of this condenser.¹

1. This article appeared on page 36 of the February, 1928 issue of QST.—Ed.

The curves and other data used in the preparation of this article were obtained in the Raytheon Laboratories at Cambridge,

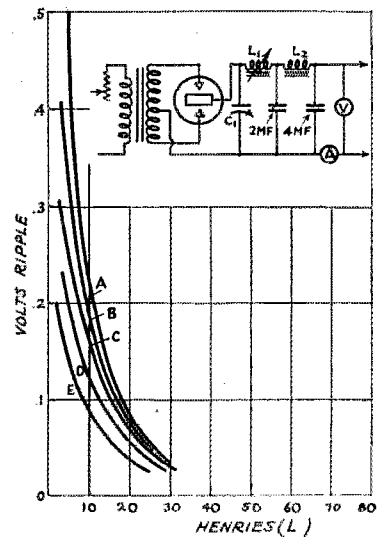

FIG. 4. EFFECT ON OUTPUT RIPPLE WHEN L_2 IS 30 HENRIES AND L_1 IS VARIED

Curve A is for no capacity and also .5 μ fd. at C_1 . Curve B is for 1 μ fd.; C for 2; D for 3 and E for 4 μ fd. at C_1 . As in all the measurements, the load current and output voltage are constant at 40 ma. and 220 volts respectively.

Mass. The standard Raytheon gaseous conduction full wave rectifiers were em-

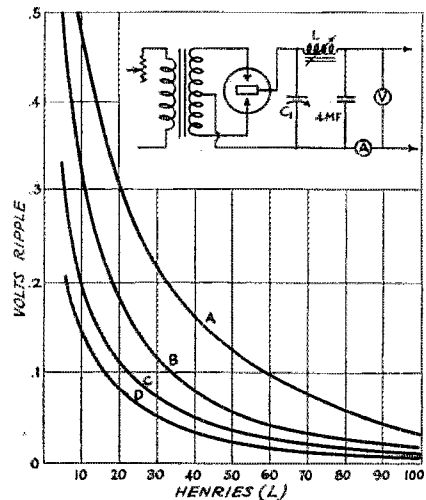

FIG. 5. THE EFFECT ON THE OUTPUT RIPPLE OF A SINGLE SECTION FILTER WHEN VARYING C_1 AND L_1

Curve A is with 1 μ fd. at C_1 ; B, 2 μ fd.; C, 3 and D is with 4 μ fd. at that position.

(Concluded on Page 31)

Some More About the Family

By A. B. Chamberlain*

AFTER reading the article entitled "Another Part of the Family," in the May issue, it was thought that some information concerning the testing of telephone circuits to prepare them for broadcasting work would be of interest to the readers of *QST*. There is nothing new in the method used at WHAM in lining up a telephone circuit and it is safe to assume that the same procedure is used at all stations fortunate enough to possess an audio oscillator and the necessary measuring instruments—in our case standard W.E. volume indicator panels, abbreviated VI. These consist of tube voltmeters calibrated to read directly in transmission units (TU) when used across a circuit having an impedance of 500 ohms which is normally the impedance of most telephone circuits at a frequency of 1000 cycles. The VI range is from minus 10 to plus 40 TU in steps of 2 TU. The input impedance is approximately 12,000 ohms, thus it does not affect the circuit it is shunted across appreciably.

The transmission unit, abbreviated TU, is a convenient method of expressing power or current ratios logarithmically. An arbitrary value "zero level" corresponds to a power of 10 milliwatts which looks like approximately 2.25 volts across a 500-ohm impedance which will cause a current flow of 4.5 milliamperes.

$$TU = 10 \log_{10} \frac{P_1}{P_2}$$

or for calculation between equal impedances.

$$TU = 20 \log_{10} \frac{E_1}{E_2} = 20 \log_{10} \frac{I_1}{I_2}$$

P being power, E voltage and I current. For a general definition we have: "A TU corresponds very closely to the minimum change of signal strength perceptible to the normal human ear."

Getting back to our telephone line. The first step consists of the usual d.c. tests for grounds, leakage, etc., made by the telephone wire-chief. The wire is then turned over to the broadcast station for use. As most circuits used are in cable the capacity is high, (.054 μ fd. per loop mile, using standard 19 ga. cable) resulting in the attenuation of the higher audio frequencies. In order that a flat frequency characteristic be obtained, the line is equalized by means of a shunt type equalizer as shown in Fig. 2. This is desirable in most broadcast sta-

tions because if good terminal equipment is used, the signal received over an unequalized telephone line of any length will sound low-pitched, drummy or is sometimes described as having a "barrel effect". By means of the shunt type equalizer an attenuation of the lower frequencies is affected, resulting in the flat curve as pictured in Fig. 1. A loss in level of 10 or more TU results, but such a compromise must be met if the desired transmission characteristic is to be attained.

Now as to the procedure used in equal-

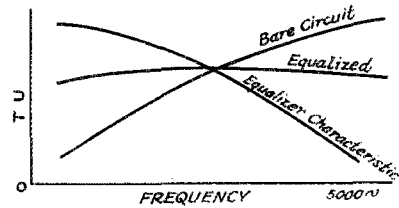

FIG. 1

izing the telephone line, we must first have a "sine-wave" signal, with less than 1% of harmonics present over a frequency range of from 90 to 6000 cycles, thus the need for a good audio oscillator. We use a well known commercial type with a range from 60 to 15,000 and higher, this instrument being very suitable for the purpose.

The essential apparatus used in our case is set up in the manner shown in Fig. 3. Let us consider the telephone lines connecting our control room with the transmitter. Three pairs are used; one is the program wire, the second is the order wire and the third is a spare for emergency service if either of the other go out. The operator at the transmitter cuts in all of the series resistance in his equalizer and instructs the control room operator at the Sagamore (15 miles away) to shoot out 5000 cycles, at normal level, usually plus 4 TU, but actually minus 6 TU on the line as the 10 TU pad indicated in Fig. 3, is in series with, and between amplifier output and the line. The pad is used in order that the VI will be reading across 500 ohms at all frequencies as the line impedance varies inversely with frequency, and in this case the pad acts as a buffer.

A pad is simply a resistance network, arranged symmetrically, and designed in this case to work between two 500-ohm impedances. This pad offers an attenuation of 10 TU which corresponds very closely to the attenuation offered by 10 miles of

*Broadcast Engineer, Stromberg-Carlson Telephone Mfg. Co.

standard cable. As the line with the equalizer across it has an attenuation equivalent of approximately 28 TU, the signal received at the transmitter is 34 TU down. The operator, knowing that the correct level on

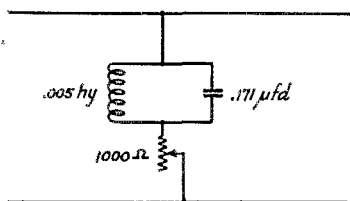

SHUNT TYPE EQUALIZER

FIG. 2

the output of the transmitter speech amplifier to properly modulate our 5-Kw. set, is minus 6 TU, adjusts his volume controls, in broadcast parlance known as "gain controls", for this level. In other words the amplifier is adjusted for a gain of 28 TU, thus compensating for the attenuation of the signal due to the losses of the line. The operator now calls for 1000 cycles. Leaving the amplifier gain strictly alone, he adjusts the series resistance (cuts resistance out) until the VI again reads minus 6 TU. Constant level is fed to the line at the control room at each frequency measured.

Now, without touching anything, he calls for 100 cycles and takes his reading. If this reading does not fall within the expected or desired limits, a slight adjustment of the series resistance on the equalizer is again made and readings on all three frequencies repeated. This operation is repeated until a satisfactory characteristic is obtained and should be within two or three TU. In addition to having equalized the circuit, the "gains" at both control room and transmitter are all set for normal operation. Now it might be well to take a "run" over the entire frequency scale viz: 90 to 5000 cycles, a reading being taken every 100 cycles or so. I can recall several instances where readings taken at 100, 1000, and 5000 cycles looked good but the quality of the modulation received over the circuit in question sounded very poor and unnatural. Upon taking a complete "run", as described above, a peak was discovered at some frequency which caused all the trouble, everything being O.K. as soon as this peak was flattened out. You can readily see that irregularities, such as the case above, come to light immediately when such a "run" is made, enabling the technical staff to take the necessary steps for correction of the difficulty.

The lines between various local outside pick-up points, sometimes called "field lines" or "Nemo" lines, and the main control room, are equalized in the same manner. In this case, instead of carrying the oscillator to the remote terminal of the line, the order wire is used to transmit the test signal to that end of the circuit. In order to match the 500-ohm impedance line to the 200-ohm input circuit of the field amplifier, a pad having the desired characteristics is inserted between them. Then the field amplifier is adjusted to give the desired output at each of the points at which the circuit is measured. In this way, the characteristics of the order wire which has not been equalized, do not enter into the equation.

The normal level at which signals, programs, etc., are transmitted over a telephone line is usually from 0 to +2 TU. The governing factor is the amount of "cross talk" to other pairs in the same cable. The local telephone company usually designates the maximum level to be used over its lines.

The various equalizer settings are posted at the control board and when the half hour pre program test is made with the field "op", the correct equalization is cut in on the particular line to be used, thus insuring an approximately flat frequency characteristic. All equalizer settings are checked from time to time with "tone" us-

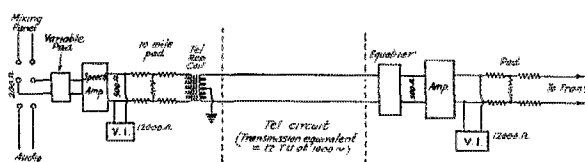

FIG. 3

ing the three test frequencies; 100, 1000, and 5000 cycles. Thus an important step toward the goal is made, the goal, of course, being a flat frequency characteristic from 90 to 5000 cycles inclusive, from microphone to antenna.

This is rather a brief outline of the procedure we use in "lining up" our telephone circuits. Several good articles along this line have appeared in various popular radio periodicals of late, notably the paper "Broadcast Control Operation" prepared by Mr. Carl Dreher of the National Broadcasting Company. This paper will be found in the April issue of the I.R.E. *Proceedings*.

In addition to this, it might be interesting to know that at our broadcast station, WHAM, located at Rochester, New York, and owned by the Stromberg-Carlson Telephone Mfg. Company, we have six operators, all being amateur or ex-amateur

"ops" and each one holding a "commercial ticket" as well. They are: Messrs. Kenneth Gardner, 8BGN, 8ASP; John J. Long, Jr., 8ABX, 2DY, 3AIW, 8CSI, 8BNV, 3UC 2MX-30V; Paul Hendricks, 1CCZ, 8CQN, 8COH; Homer DeWitt, 8BRD, 8DBI, 8DCQ (portable); Merriam Johnson, 8BVD; Frank Kelly, 8DZA. Mr. Raymond Lucia, 8BEN, is to become a member of our technical staff soon, and in our program (studio) department, we find Victor Martin, who has been or is connected with 8HR, 8LP and 8XAC. This is most certainly statistical proof supporting a statement or two in the article referred to, and is just about a 100% record.

8DBI, operating on 40 meters, is located at the WHAM transmitter quarters at Victor, New York. The 7th harmonic of the broadcast transmitter frequency, 1070 Kc. is used. The main antenna which acts as the radiator is an 180-foot, six-conductor, vertical cage. A crystal-controlled oscillator is used to check and maintain the frequency of the 40-meter set.

Notes on Filter Circuit Design

(Continued from Page 28)

ployed. For measuring the ripple in the output, a vacuum tube voltmeter in connection with a resistance coupled amplifier was employed. The voltmeter was calibrated to read volts r.m.s. The values of inductances, used for each measurement, were determined as a result of measurement (with vacuum tube voltmeter and standard resistors) under actual operating conditions of a.c. and d.c. current. The d.c. load of 40 ma. was selected after a rather comprehensive survey of all the different radio sets on the market during the past few years, which showed quite conclusively that very few sets required more than 35ma. of "B" current.

The Hudson Division Convention

THE third annual convention of the Hudson Division was held at the Hotel Pennsylvania, New York City, May 25-26, and a well-arranged program was carried out under the supervision of Dr. Walsh, 2BW, Chairman of the Convention committee. While there was a little delay in starting the events Friday, this was

soon forgotten when Boyd Phelps got his Woolworth Boys (5-and 10-meter gang) going and then following him came that old timer R. B. Bourne, 1ANA, with something new; a good talk and demonstration on acoustic filters. Mr. Edgar Felix, contributing editor, Radio Broadcast, proved himself a most interesting speaker with his lecture on the Cooley Ray Photo system. The day ended with a code speed contest with our old friend John Clayton among the winners. It is understood there were ham-fests at different hamshacks the rest of the night.

The Saturday activities started with the regulation traffic meeting under the able supervision of J.B. Kilpatrick, 2EV, who is SCM for greater New York. The forthcoming problems were discussed and timely suggestions made by A. A. Hebert from Headquarters. The Army-Navy-Amateur meeting was well covered by Lt. David Talley and Ensign Fulk. We were also pleased to see Capt. Autry of the Signal Corps, as he has always shown the greatest of interest in the amateur.

During the contests and stunts period a lot of fun was created when a number of OMs and two YLs transmitted the alphabet backwards with their heel—if you think it is easy try it.

New York has always been noted for noisy banquets and this one was no exception and the delegates from the Bronx Radio Club won hands down—they can't resist Swyx. Seriously, the large number of guests enjoyed every minute of the evening. Our good friend Dr. Goldsmith, Chief Broadcasting Engineer, National Broadcasting Company, during his speech gave us a lot of food for thought. Director Dunn received a real ovation when he was introduced by Toastmaster Walsh, Dr. Woodruff, Director of the Atlantic Division, was one of the guests. He is proving himself the Will Rogers of amateur radio and it looks as though he will have the honor of attending more conventions than Treasurer Hebert this year if he keeps up the same pace. Hi! As expressed some time ago by this reporter, the distribution of prizes as the last event after the banquet certainly keeps the crowd together and the Hudson Division was most fortunate in having been favored so generously by the manufacturers, resulting in so many awards that lack of space prevents us from mentioning the names. However, the thanks of every one goes to the Convention Committee.

—A. A. H.

A Super-Regenerator for Short Waves

By George B. Hart*

THE circuit of this receiver may be seen in the drawing and is fundamentally a simple two-circuit short-wave receiver to which has been added super-regeneration in its simplest form. While you are examining the circuit, note particularly that the long-wave super circuit is *grounded*. The grid leak R_2 should be of the very best material and variable, as a great deal depends on the efficient operation of the grid circuit. If extreme sensitivity is desired, the grid condenser C_4 may be variable, otherwise it should consist of a .0001 μ fd. fixed condenser. C_3 is a small vernier condenser of about .00005 μ fd. maximum capacity. C_2 , the tuning condenser is a .0001 μ fd. variable condenser and C_1 the feed-back condenser is a .00025 μ fd variable condenser. L_2 , the radio frequency choke coils consists of 125 turns of No. 26 d.c.c. wire on a three-inch form. C_5 , the phone by-pass condenser is a .001 μ fd. fixed condenser.

The following table shows the necessary number of turns on L_1 and L_2 for various wave-bands:

L_1	Wavelength in Meters	L_2
19 turns	113 to 58 meters	4 turns
10 "	70 to 35 meters	4 "
6 "	45 to 23 meters	3 "
3 "	26.1 to 15.4 meters	2 "
1 "	12 to ? meters	2 "

THE SUPER CIRCUIT

Now we come to the long wave circuits upon which the set's successful operation depends. If these circuits are not working properly the whole thing will be worthless and will operate with the same old disturbances so common and so troublesome in supers in the past.

The grid coil L_1 is a honeycomb coil of 1250 turns, shunted by a .001 μ fd. fixed condenser C_3 . This value is critical, so if you have a variable .001 μ fd. condenser you may use it.

The plate coil L_2 is a honeycomb coil of 1500 turns, shunted by a .0025 μ fd. fixed condenser. This coil is placed so that the coupling between it and L_1 can be varied easily from very close coupling to right angles.

OPERATION

Turn on the filament with R_1 , tighten the coupling between L_1 and L_2 until the point of oscillation is reached and passed and about to stop. This is a very critical point and it will take two or three trials to find the best place. However, once it is set it need never be readjusted. A very faint high pitched hum will be heard and this can be eliminated by the proper adjustment of the variable grid leak R_2 . Now tune for the signals with the usual con-

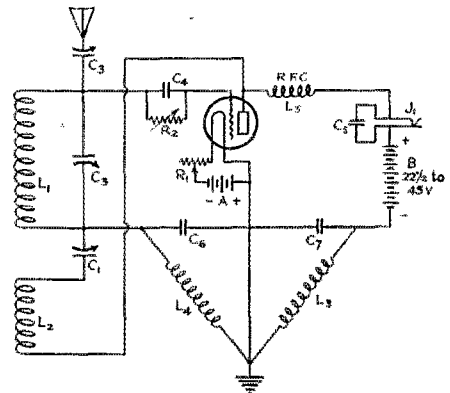

USE UV199 TUBE OR 6D11-12 TUBES FOR BEST RESULTS

trois of the tuner. If signals are not heard readjust the grid leak until the signals are heard. When the grid leak and the coupling between L_1 and L_2 are adjusted properly the signals will burst in without any trouble from the variation frequency.

RESULTS

The set has few of the usual unpleasant 'super-regenerative' characteristics. Selectivity is very good; signal quality is excellent and the volume is enormous for one tube. The set when properly constructed will give results equal to those of the average two-tube receiver (detector and one audio). The set has a decided tendency to hang on to swinging signals, this is indeed an advantage on short waves where one hears so many signals that are not only weak but also swing from one end of the dial to the other.

Remember, however, that without *good apparatus* this circuit will *refuse to work efficiently*.

*Hart & Hart Radio Laboratories, 3267 Nash Ave., Cincinnati, Idaho.

Relays for the Amateur

By G. F. Lampkin*

IT IS a novelty, to say the least, to sit down to a ham transmitter and do nothing more to start it than give a preliminary dah dit dah dit dah—and then have it stop itself a couple of seconds after the final K. Such operation can be had by the use of relays that are easily made. With them, break-in takes on a new meaning; and many other possibilities are opened in the way of remote control and automatic sending with the transmitter.

As nearly all amateurs use 110-volt, 60-cycle a.c. as their power source, it would be well to construct relays to operate directly on this source, and do away with any necessity for batteries or other apparatus. The magnetic path in a.c. relays is usually made of laminated transformer iron, to reduce the losses due to eddy currents, hysteresis, etc. But the laminations are comparatively hard to get and are difficult to work with. Ordinary soft iron, or black iron, can be

are linked up by the equation, for 60-cycle a.c.—

$$E = \frac{266.5 \times n \times AB}{100,000,000}$$

And to find the number of turns—

$$n = \frac{E \times 375,000}{AB}$$

A guess must be made as to the size of the core window that will hold these turns.

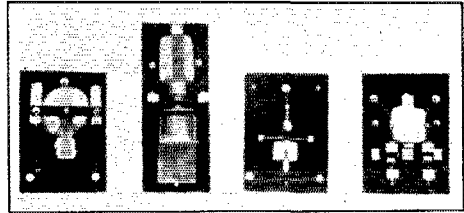

A FRONT VIEW OF THE FOUR COMPLETED RELAYS

From left to right are the power contactor, delayed time relay, small keying relay and large relay.

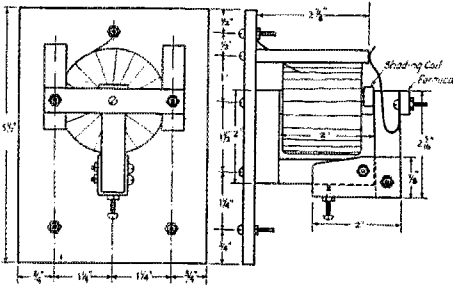

FIG. 1 POWER CONTACTOR

used for the core of an a.c. magnet, and the losses, or power consumption, will not be more than that of a 40-watt lamp. Neither will the heating of the core be excessive.

In designing the winding to be put on a core of given area, the voltage on which the relay is to operate is known. The flux density in the core, which determines the heating of the core, can be made 60 or 70 thousand lines per sq. in. The pull of the magnet varies as the square of this density, and is proportional to the core area, for any given density. If the flux density is denoted by B, and the core area in sq. in. by A, then the total flux in the core is the number of sq. in.—that is, AB. The voltage, E, the number of turns, n, and the total flux, AB,

The tentative core volume is then figured. From Curve No. 1, the volt-amperes per cu. in. necessary to give the assumed flux density can be found. This value, multiplied by the number of cubic inches volume of the core, gives the total number of volt-amperes; and the latter figure, divided by the voltage, gives the amperes that will flow in the coil. The size of wire is determined by this current; for a keying, or similar duty relay. Where the current is on and off for very short periods, one circular mil of wire area can be allowed for every four milliamperes of current. For a relay that is on for longer periods (ten or fifteen minutes) one circular mil of wire area should be allowed for two milliamperes of current. Wire tables that can be had from any wire manufacturer will give wire diameters and areas.¹ The diameter of the bare wire will be increased about .010", or 10 mils, by a double cotton covering—the extreme case. This value should be added to the diameter of the bare wire, and the area occupied by n turns of this size, laid side by side, figured. Fifteen percent should be added to allow for coil insulation, wind-

*SALK and 'fo' at SCAU, University of Cincinnati. Home address, 3612 Woodbridge Place, Cincinnati, Ohio.

1. A wire table appears in the Radio Amateur's Handbook which also gives the number of feet of wire per pound from which the amount of wire needed for a given winding may be computed.—Tech. Ed.

ing irregularities, clearances, etcetera. The resulting area must be checked back to see that it will be contained in the size of core window that was assumed. If not, a more intelligent guess can then be made as to the core-window size. This figuring may

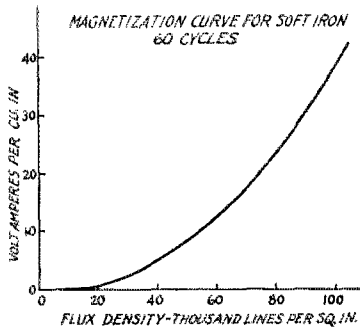

CURVE SHOWING THE NUMBER OF VOLT-AMPERES NECESSARY FOR EACH CUBIC INCH OF CORE VOLUME TO GIVE A CERTAIN FLUX DENSITY PER SQUARE INCH OF CORE CROSS SECTION

seem to be a lot of useless bother, but a calculation approximate within 10 or 20 percent. is easily better than a guess that may be off 100 percent.

The core for the power contractor of Fig. 1 is made of 1/2" square soft iron bar. The

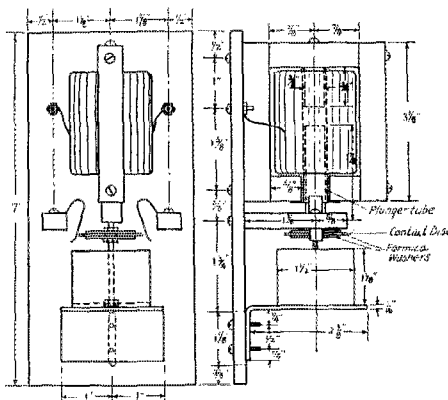

FIG 2 DELAYED TIME RELAY

area is 1/4 sq. in. At a flux density of 65,000 lines per sq. in., the total flux is 16,250, and the turns

$$n = \frac{110 \times 375,000}{16,250} = 2,540.$$

If the core window be made 2" x 1", the

total length of bar would be 8 inches, and the volume $8 \times \frac{1}{4} = 2$ cu. in. At 65,000 lines, the excitation per cu. in. is 14.5 volt-amperes, from the curve given. The total volt-amperes would be $2 \times 14.5 = 29$, and

$$\text{the amperes } \frac{29}{110} = .264. \text{ Allowing one}$$

circular mil for two milliamperes, the wire area must be 132 circular mils. Number 28 is the nearest even wire size, with an area of 158 circular mils. The diameter of No.

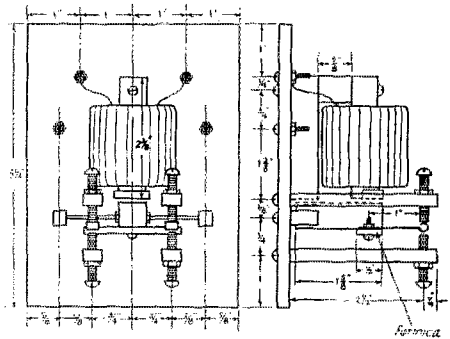

FIG 3 LARGE KEYING RELAY

28 bare wire is .0126"; insulated with double cotton covering, its size is .0226". And 2,540 turns of this size would occupy $2,540 \times .0226 \times .0226 = 1.3$ sq. in. Adding 15%, or .195, the total coil area would be 1.5 sq. in. As may be seen, the 2" x 1" core window is of ample size,

The rest of the design is concerned with mechanical details, and the drawings and photos show those. To prevent the armature from chattering, what is known as a shading coil is used. It is a single turn of copper strap, that is hammered into a hacksaw slot in the face of the pole, and the ends bent around, overlapped, and soldered, so as to encircle half the pole face. The size of the strap is not overly important. The shading coil acts as the secondary of a transformer, and has induced in it a voltage that is out of phase with the voltage of the main coil. Thus the flux through its section of the pole does not pass through zero at the same instant that the other flux does, and there is always a pull on the relay armature. The screws that hold the core pieces together should be iron, so as to leave a minimum of non-magnetic spaces. The armature is fastened rigidly to the aluminum, or brass, hinge piece. The hinge piece is pivoted on the lower horizontal leg of the core, and the armature opens the contacts by its own weight. The set screw in the bottom of the hinge piece is provided

as a backstop. The contact arms are made of aluminum from a variable condenser plate. They make contact when the armature is about an eighth of an inch away from the pole face, and the remainder of the closing action gives then a good wiping motion. An air gap of about $1/32''$ is left between the bottom pole piece and the armature, so that any residual magnetism will not be able to act with sufficient strength to hold the contactor in, after the operating current is cut off. The power contactor is essentially a double-pole, single-throw switch, and will handle ten or fifteen amperes.

The delayed-time relay was made for automatic starting and stopping of the transmitter. It is operated by the transmitting key, and closes its contacts almost

of No. 30 enamelled, or s.c.c. wire.² One-quarter pound of wire will be enough to wind the 2,600-turn coil. One-half-pound

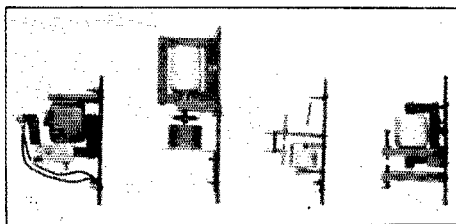

THIS SIDE VIEW SHOWS THE FOUR RELAYS IN THE SAME ORDER AS THEY APPEAR IN THE FRONT VIEW

of the same wire will wind the coils for the delayed-time and both keying relays.

The central core of the delayed-time relay is made of a $3/8''$ carriage bolt; the yoke is of $1/2''$ square soft iron. The plunger carries a threaded brass rod, on which is clamped the contact disc and the dashpot piston. The dashpot is made of $1 1/2''$ brass tubing soldered to a brass shelf. A metal shell from a vacuum-tube socket, or a tin snuff box, can be made to serve for the dashpot. It is filled with Nujol, automobile oil, or other viscous liquid. The piston is made of a loose-fitting circle of tin; the time element of the relay can be varied by changing the liquid for another of different viscosity; and by boring holes in the piston. These holes can be covered on the underside by a piece of good bond paper, so as to give a flap-valve effect. It is better to have a heavy liquid, and many holes in the piston, than vice-versa, for the liquid is not so likely to splash. The travel of the piston is regulated by moving the dashpot shelf vertically. The contact disc has an oversize hole in the center and is clamped between two Formica discs, so that it is insulated from the plunger rod. The contact strips are made of thin aluminum or brass. If the contacts as shown do not handle the current well, a flexible lead may be connected to the disc, and the two contact strips put in parallel. A tube of thin metal, non-magnetic, is placed inside the coil to protect it and give the plunger a smooth working surface. A slit is left in the tube, to prevent eddy currents. A small rubber washer is placed on the top of the plunger to soften the impact on closing, and to maintain an airgap.

The small keying relay shown in Fig. 4 operates on 8 or 10 volts a.c., and works admirably in the center tap, or grid leak, where heavy currents do not have to be broken. It can be operated from the fila-

2. Due to the varying magnetic field, the enamel insulation may chafe and result in the short-circuiting of a section of the winding.—Tech. Ed.

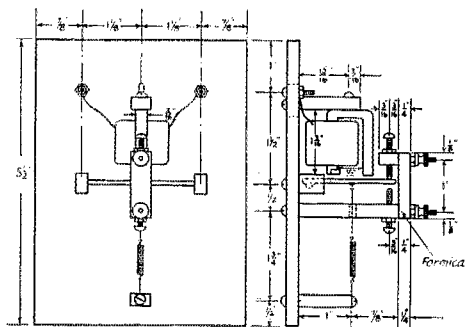

FIG. 4 SMALL KEYING RELAY

instantaneously, but takes some three or four seconds to open them. Thus the transmitter starts up as soon as the key is pressed, and remains running as long as the key is not idle for more than three or four seconds. A keying relay must be included in the circuit that is controlled by the key. A large, heavy duty keying relay was made, as in Fig. 3, to operate in series with the delayed-time relay. The keying relay has four contacts, two opening and two closing; it can be used for simultaneous keying in the grid and plate circuits, keying in the plate supply with backload, or other methods that require a multi-contact relay. The core is of $1/2''$ square soft iron. The contact strips are made of aluminum condenser plates. The winding consists of 1,300 turns of No. 30 d.c.c. wire. The winding of the delayed-time relay, for use in series with the large keying relay, consists of 2,000 turns of the same size. The latter relay, however, is comparatively noisy, and if one for heavy duty is not required, the small keying relay works satisfactorily. To work in series with the small keying relay on 110 volts a.c., the delayed time relay should be wound with 2,600 turns

ment transformer; and has front and back contacts. The coil is wound with 1300 turns of No. 30 enamelled or s.c.c. wire. The core is a 3/16" dia. nail, or spike, bent to the shape shown. The armature is a piece of the nail, pounded flat. A piece of No. 12 wire is soldered to it as a shaft, and is pivoted in the small blocks. The pivots should not be loose, or the relay will chatter badly. A small hook of wire is soldered to the back of the armature, and a thread run between the hook and the spring, and from the spring to the stud. Rubber bands can be used, in the absence of a spring. Adjustment of spring tension, contact spacing, and position of the magnet can be made so that the relay will not hum or chatter, and will follow at 35 or 40 words per minute. If necessary, the contacts on this or the other relays may be made of silver, or tungsten, for heavier currents.

All the coils should be wound with enamelled or s.c.c. wire. The former makes by far the most compact coil, for a given number of turns. The winding form should have a diameter about 1/32" larger than the maximum diameter of the core; the disc, or flange on one end of the form should be removable. A layer of fairly heavy

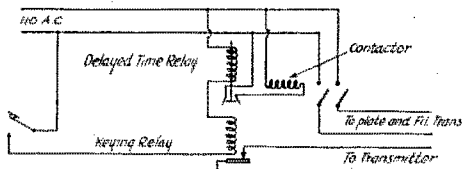

FIG 5 RELAY CIRCUIT FOR AUTOMATIC STARTING

twine should first be put on. The two strips of cotton tape, or string, are laid lengthwise of the form and the ends left hanging free. A couple of layers of heavy paper, or postcard, are wound on as a base for the coil, and then the winding proper is put on. It may be jumble wound, for comparatively low voltages are used. When the desired number of turns is on, the free ends of the cotton tape are brought back and tied over the winding, to hold it together while taking the flange off and pulling out the twine. The coil can then be easily slipped off the form, and be taped up with linen or cotton tape. When slipping the coil on the core, a layer of asbestos paper can be used to wedge the coil on tightly, and will further protect it from any heat of the core.

The circuit of Fig. 5 shows how the relays are hooked up for automatic starting of the transmitter. The contactor is controlled by the delayed-time relay, so that heavy currents may be handled. If the transmitter load is not more than an ampere or

so, the delayed-time relay might be made to handle it directly. For remote control, only one control wire is needed. For remote control by radio, the relay in the output of the control receiver need only be connected across the key. In fact, the relay set-up was first made to be used with remote control by radio, and for the last year and a half has been in constant operation at 8CAU, the station of the Department of Electrical Engineering at the University of Cincinnati.

Official Wavelength Stations

The Official Wavelength System furnishes a service cooperative with, but differing from, that of the Standard Frequency Station, 9XL, which is also operated in accordance with plans made with the O.W.L.S. Committee. Contact with the O.W.L.S. is through Mr. D. C. Wallace, who is also chairman of the committee. Mr. Wallace is continuing the work of checking up all O.W.L.S. to make sure that they are really indicating their wavelength (or frequency) at the end of each transmission—and are doing so with proper accuracy; which is to say 2%. They do this in the course of regular operation and do not send calibration schedules as do the S.F. stations.

The list is as follows:

6XAO-6ZV, 5MN, nc4FC, oz2AC, 6AM, 1CK, 1AWW, 8EQ, 4XE, 5ZAV, 9EGU, 6ZH, 2MU, 4BY, 5SP, 7GQ, 2DS, 1BZQ, 6BGM-6CVO, 9IG, 1ZL-1AVW, 2CLA, 8GZ-8ZG, 9BGK, eg2NM, nc9AL, 8APZ, 5OX, 1AAC, 8BZT, nc3CO, eg2OD, 6CAE, 9AXQ, 9CPM, 5EW, 1AXA, 9BGH, eg2SZ, oa5BG, 4LK, eggi5NJ, 1CCW, 8BAU, 9UZ, 2EF, 6AWK, 6CDY-6CPK, 6AYC, 6BRO, 6BB, 8DAJ, 9AUG, nc2BE, 2BRB, nc4BT, 6WN, 6BMW and 6CMQ.

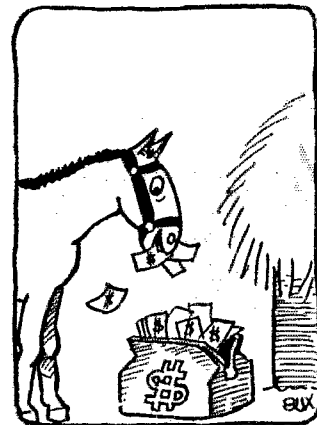

A PLUG IN THE JACK

Tests on a Method of Voltage Feeding the Antenna

By Joseph Fuchs*

IN the following lines I will inform the OB's on the matter of an aerial system, which includes an excellent constancy of frequency and a very good efficiency and which is, I hope, for many amateurs, a simple solution of the antenna problem.

Fig. 1 shows the principle. The tuning circuit of an H.F. oscillator is coupled inductively with a tuned intermediate circuit of the same frequency. The aerial is now connected galvanic with this circuit L_2 , without any coupling condenser. The distribution of current and voltage is very interesting: If L_1 induces energy to L_2 , it appears there a potential loop at the points a and b. If L_1 and L_2 are tuned in on the aerial, it will be excited by voltage, because in this case there lies also a potential loop on the end of the aerial. The same occurs if L_1 and L_2 are tuned in on harmonic frequencies of the aerial.

There are some particular advantages of this arrangement. If the aerial, L_1 and L_2 are in resonance together (a case of pure voltage-feed of the aerial), the intermediate circuit L_2 represents a quite independent electrical system, which is not influenced by the damping resistance of the aerial. It is clear, that this intermediate circuit, which consists only of one coil and one condenser (low loss!) has almost no damping. This makes possible an extremely loose coupling with the tuning circuit L_1 of the oscillator. This loose coupling lessens all reactions from the aerial to L_1 , for example the variations of the antenna-capacity by staggering of the antenna. In fact, during the whole period of working, no QSSS was observed.

The tuning will be effected by measuring the current of the intermediate circuit; it is evident, that there will be (if inputs of more than 15 watts are used) a current of many amperes. If the coupling between L_1 and L_2 is too strong, we can find the well known *two* tuning waves. L_1 and L_2 are tuned *exactly* on the natural frequency of the aerial or one of its harmonics.

The antenna-current is measured by an ammeter into the aerial itself.

Fig. 2 shows a diagram concerning the relation between the current of the intermediate circuit and the frequency. The first tests are made with an aerial of 2.35 megacycles natural frequency; we see dis-

tinctly the maximum of the L_2 -currents at the harmonic frequencies of 4.70, 7.06, 9.40, 11.76 etc. megacycles.

It is very interesting, that all these maxima are not sharp; on the contrary, a band of 0.8 megacycles is always at hand for use. (Function of the damping of the aerial.)

It seemed useful to examine the radiation of the antenna at those frequencies, which are in a harmonic relation to the natural frequency. The examination

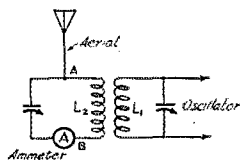

of this case gave the result, that this arrangement is always radiating if there exists any H.F.-current in the intermediate circuit L_2 . It is evident, that the frequencies nearer the natural frequency or one of its harmonics, are better radiated than the frequencies in the middle of two harmonics. A current in L_2 is always a sign that the aerial radiates power in the air.

One day I sent Standard Frequencies from 5 to 10 megacycles with an input of 30 watts. They are received in Esthonia (1400 kilometers from Vienna, Austria) with the following audibilities: (Receiver 0-v-1)

Frequency in Megacycles:	Audibility
5.00	r 4
5.67	r 3
6.52	r 5
7.68	r 7
9.37	r 7

The natural frequency of the one-wire aerial was 2.35 megacycles. (We see clearly the influence of the skip distance in respect to the audibility.) It is not difficult to understand, that this arrangement has many advantages over other systems, particularly in the case of portable stations.

The investigation has extended also to broadcasting waves and the higher wavelengths of commercial traffic: the result

*EAAA & EAFZ, Jasomirgottsstrasse 5, Vienna, Austria.

Becoming an Operator in 15 Minutes

By Don C. Wallace*

THE Experimenters' Section has not listed one problem. This is the problem of speed in making amateurs. The making of an amateur may take from fifteen minutes to fifteen months, depending upon just how strong the desire may be.

For the past six years Mrs. Don Wallace has been interested in amateur radio only to the extent of letting the OM run the set how and when he so desired. A few weeks ago Mrs. 6AM and 6AM were talking over the possibilities of QSO while 6AM was away on some of his long business trips. The Hartford bunch for example may remember one trip which even landed 6AM in Hartford for a day.

During this discussion Mrs. 6AM said she would try to master the art, so one evening just before leaving for Canada a complete fifteen minute lesson was given. So others may profit thereby we shall try to outline each detail of "making an amateur in fifteen minutes".

Several prerequisites are necessary. For instance the transmitter should be fool proof, simple to start, and one which will not blow up—thereby causing a loss of interest. The same main line power switch has started 6AM, ex-9ZT, ex-9DR, for over five years. That switch has never changed its looks or its position on the set during that time. Perhaps it will stay there for the next five years. If so, we will never have to repeat the simple instruction, "To start the set, push in this switch; to stop it, pull it out." In addition all switches in the radio room are labeled with a small typewritten label, stuck with collodion to the bakelite or metal panel upon which that particular switch is mounted. Except when changing bands, no other switch need be touched. Thus when visitors desire to run the set, it has always been simple.

The receiver must be solid, foolproof, and marked directly in wavelength. That was done for the occasion, and now that the job is done, it is found well worth while for 6AM, Mrs. 6AM, or visitors. The set uses a shield-grid tube and has an extra amount of sensitivity making it especially easy for Mrs. 6AM to find the distant stations. The instruction as to how to run the set was this: "Tune the set just like the Browning-Drake we use on broadcast bands." That sufficed for the receiving instructions. As a matter of practice Mrs. 6AM then tuned in a station on 41 meters,

one on 38, and one on 37.5—just to get the "feel" of the receiver.

The next was code instruction on a buzzer. All the instructions necessary were, "Make the dashes extra long and make the dots extra short, and the spaces between letters extra long." With that as an instruction Mrs. 6AM sent beautiful stuff at about 4 words per minute. At 4 w. p. m. we could exchange 20 words every five minutes, i. e., considerably more than a great many old timers do, in the same amount of time.

Under a piece of plate glass in the radio room is the code, Q signals, R signals, and plenty of such data. No instructions were given on these, as Mrs. Wallace can read, and evidently has done so.

If 6AM then sent four words per minute Mrs. 6AM could copy down the dots and dashes, translating it later—perhaps not an ethical way of receiving, but certainly

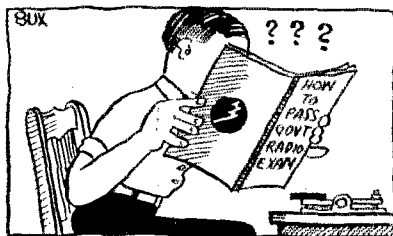

QRW

effective as shown by the fact that during the next two weeks three schedules were kept at distances over 1000 miles. 7BB and 7XF of Seattle furnished stations for two of the schedules, and 7MO of Portland, Oregon, the last one. No schedules have been missed and judging from the letter received from Mrs. 6AM, written after the first schedule with 7BB, another new amateur has been added. She received the first sentence, thereupon became excited, later writing "It's fun."

The second QSO, i. e., the one with 7XF, has been saved, and is as follows:

Mrs. 6AM, "All fine here, did you get your fudge in Seattle? Gladys was here yesterday. You are about R-6 or 7. Children woke up I will be on again at 4."

Mr. 6AM, "Fudge arrived thanks. You R6 will call you from Portland, Wednesday, five-thirty P. M. Thirty-nine meters."

*6AM, 109 W. 3rd St., Long Beach, Cal.

Filament Supply Progress

By W. J. Halligan*

IT has, for several years now, been possible to rectify low voltages with the aim in mind of house current filament supply. The lone difficulty, however, has been in filtering the rectified current. Various methods have been attempted but all were messy and otherwise generally unsatisfactory.

Two devices have just been developed which, it is expected, will for all time put an end to this problem; the first, a low-voltage condenser bank of approximately 4,000 microfarads, and the other a filter unit which combines the condenser with the proper choke combination for perfect filtering.

The problem was to build a condenser of extremely high capacity, but that was small in size and low in cost. The obvious direction to work in was to create some kind of dielectric path between the condenser plates that would be of molecular dimensions.

The first experiments were made by Stratford B. Allen assisted by Alden S. Cook with the idea of producing a semi-

cal action. Allen finally arrived at the idea of limiting the dielectric to the oxide film which is practically inherent in pure aluminum exposed to the air; except that such a film must be continuous and of practically molecular thickness to insure high capacitance and lower chemical action. Means were then employed to prevent as far as possible the formation of the gas

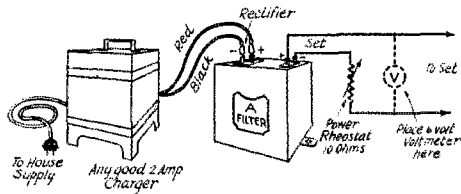

dielectric film, and an immediate high increase in unit area capacitance was the result. With the able cooperation of Mr. Cook, the problem was finally whipped into commercial form.

Measurements made by W. K. Fleming, research engineer for the Raytheon Manufacturing Company, show the commercial form of the device as having 1800 microfarads in one section and 3800 microfarads in another section. This brings a total of 5600 microfarads in a space of 5 by 5 1/4 by 1 1/2 or 43, cubic inches, a feat never before commercially accomplished, in the belief of various engineers.

The breakdown voltage of the condenser in this discussion is 50 volts and the life appears to be indefinite when the condenser is used at voltage well below this limit.

The polarized type of condenser was found to give considerably higher capacities. In this type of condenser the plates were one of lead and the other of aluminum foil. It was possible, however, to make condensers by this method that were not polarized, but for practical purposes, the larger capacity polarized type was the more desirable.

An 'A' filter, which includes the high capacity condensers and the proper arrangement of chokes, has, in addition to radio, many varied applications. Vault and burglar alarms, inter-communication telephones, special low voltage signalling systems—all these offer a wide field for an a.c. converter delivering 6 volts of direct current.

The application of such a converter to radio uses is quickly apparent. The a.c.

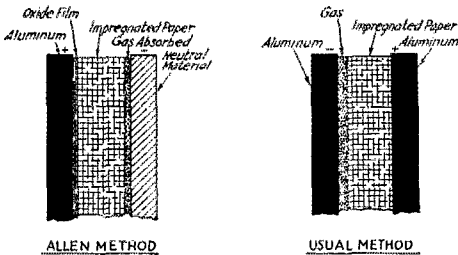

dry high capacity unit, based on the theory of other similar condensers, namely, the formation of a gas dielectric on an aluminum plate.

Experimental work which was done in the development of these condensers showed up many interesting features. For instance, the condensers made with the gas dielectric tended to build up in thickness and suffer a reduction in capacity. This was also true of condensers built on the gas theory that were nearly completely dried. It became apparent that more was yet to be done to prevent excessive evolution of gas, and consequently the slow lowering of capacitance, with eventual deterioration of the plates from slow chemi-

*Sales Manager, Tobe Deutschmann Co., Cambridge, Mass.

tube is still very much in the class of the elusive atom—still unharnessed. This, in spite of all the brilliant efforts of various manufacturers to develop devices to do just that thing to the a.c. tube.

Only a few of the very patent difficulties which have shown themselves in a.c. receivers are: An annoyingly noticeable a.c. hum; wierd and indefinable noises of an-

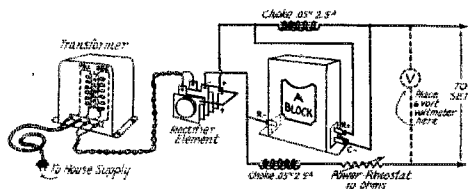

other character; weak and fading signals; terrible tone, and lastly (and most important from the all-important point of the pocket book) premature burning out of the tubes themselves.

It is a matter of technical fact, that line noises cannot be filtered on an a.c. tube receiver. An answer might be made that 'such-and-such a commercial a.c. receiver has no hum.' The 'retort propre' to this is that *if the hum has really been removed*, it has been done at the expense of the quality of reproduction. Another fact is that only a limited number of stages of amplification may be employed in a.c. sets. The noises encountered in a multi-tube circuit are terrific. They will very probably be brought under control in the future, but as yet little has been done.

Up to the present time, no shield grid tube has been designed for a.c. operation. It, of course, is technically possible to place upon the market such a tube, but the manufacturers do not want it, and even the engineers are looking for some satisfactory device which will save them from being forced to the adoption of the still doubtful advantages of a.c. tube operation.

Tungar or other full wave rectifiers may be used with equal success. Considering all the advantages, the cost of such a converter is amazingly small.

1—Most people are incredibly uncritical on this point at present. They will become vastly more critical in another year, just as the public became critical of the old type of phonograph.—Ed.

Becoming An Operator in 15 Minutes

(Continued from Page 38)

Mrs. 6AM, "I will have to translate your message. Will call when I finish. . . Here I am again Message R Wed. at 5. Thirty 39 meters I am having domestic QRM here. By the way 5 thirty is bad time for me."

Mr. 6AM, "Please get Marlyn (girl next door) Wednesday. Must go now (etc.) SK."

Some of the details of the QSO aren't exactly orthodox as yet, but we feel that those three QSO's have been worth months and months of instruction. One thing for instance is that when Mrs. Wallace makes an error she corrects it by making seven dots and goes back *one letter* instead of a full word. I think that is original with her and certainly saves time. Calling and answering seems to be puzzling as yet as she usually calls 6AM and signs whatever station the schedule is with. All that can be corrected much better now than before.

The important thing is that she got on the air, had the desire to operate, and did so, and three highly successful QSOs resulted.

THE SCHEDULE USED

B. Check time with office on day of test.

Before test—B—run omnigraph few minutes.

First 5 Minutes. Don call nu6AM.

Second 5 minutes. B call Don and say whether or not Don is R-O, R-6, etc., and send 6 or 7 word message.

Third 5 minutes. Don will say R-O, R-5, etc., and start sending message.

Fourth 5 minutes. B Call "Don" or station call, sending message.

Note (1). Schedule subject to change during third and fourth 5 minutes periods if reliable communication is established before that.

Note (2). Don may not always find a suitable station for the schedule, so if no results are obtained Bertha discontinue, in 25 minutes, and show up on next schedule time.

Note (3). If interruptions from youngsters or telephone occurs, B to say nothing and simply turn on *omnigraph*. Don will know this means "wait."

Strays

The UX852 contributed by Alpha Sigma Delta to the West Gulf Division Convention was won by 5AKN and not 5ANK as reported in the April QST. "My two little 210's are getting mighty weary of upholding the reputation of an 852", writes Wells of 5ANK. "They will be saved a lot of effort if the statement is corrected."

A Resonance Testing Method

By A. E. Teachman*

WITH the permanent establishment of the principle of single dial multiple-ganged tuning control of Broadcast receivers comes the attendant problem of determining whether or not the condition of resonance has been satisfied. Manufacturers of receivers have adopted for use in their factories various and usually elaborate means for testing the conditions of resonance. These, however, are usually quite out of the reach of the service man or the fan who wishes to make tests on his own receiver. The apparatus and method here discussed are offered as a simple and practical solution of the problem.

The only apparatus required is a grid-meter driver with a range of 200 to 550 meters. Fig. 1 illustrates the general scheme of things. The circuit of the oscillator shown in the figure is recommended as being somewhat easier to use than the Hartley and some other circuits as it is not so touchy about hand capacity effects, and need not be shielded. A ground on the filament circuits of the receiver and oscillator is usually sufficient. A large tickler is needed to produce strong oscillations at the high wavelengths. The 199 is used with two dry cells (no rheostat) and 22½ volts on the plate. This makes for simplicity and an apparatus that is conveniently portable; a valuable point for the service man. The grid milliammeter has a range of one mil and the scale length should be 2.3 inches or longer. The longer the scale length, the easier it is to determine the point of resonance.

The operation of the apparatus is very simple. The grid of the oscillator is coupled to the grid of the circuit under test through a sort of radio frequency line. This consists of a wire from each grid connected to a small coupling capacity. The capacity should have a variable range from about two to ten picofarads. The six-inch pieces of bus bar wire which slide through two tightly bound pieces of spaghetti will serve the purpose. One of the tuned circuits of the receiver under test is selected as a reference circuit i.e., one to which all of the other circuits should resonate. The r.f. line is clipped on to some point on the grid side of this circuit such as the condenser or coil. This can be accomplished without disconnecting the receiver or removing the chassis from the cabinet. (If there is a grid resistor in the circuit the clip should not be placed at the grid post

of the socket.) The oscillator vernier condenser is set at 50° and the main tuning condenser of the oscillator adjusted to a low wavelength. The main tuning control of the receiver is then rotated until the circuit under test is in resonance with the oscillator. This will be indicated by the dip of the grid meter. If the coupling capacity is too great the circuit under test will tend

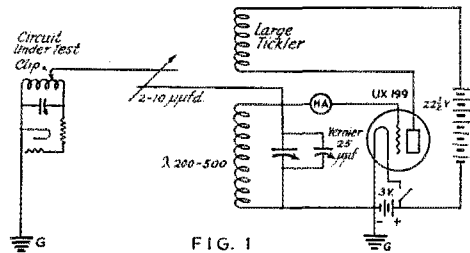

FIG. 1

to pull the frequency of the oscillator. This will be indicated by a quick snapping up of the grid meter pointer after the minimum reading is reached. The coupling capacity should be just sufficient to give a discernable dip at resonance. It will be noted that the transfer capacity will have to be increased for the higher wavelengths.

With the oscillator and the reference circuit in resonance, the main tuning dials of the receiver and the oscillator are left alone. The r.f. line is then successively clipped to the other circuits. The vernier condenser of the oscillator is rotated at each test and if the circuits are in resonance the greatest dip of the grid meter will occur at 50° on the vernier dial. If a circuit is not in resonance, the reading of the vernier dial at minimum grid-meter deflection will indicate how much the circuit is out and whether it is high or low with respect to the reference circuit. The user can set his own standards as to how much difference in the reading of the vernier dial is permissible for a good receiver but suffice is to say that the degree of the accuracy of the indication can be made greater than the accuracy of any receiver now produced. The tests are repeated at a number of wavelengths and the results charted. An examination of the chart will show how the circuits follow along and what corrective steps to take.

Inductances may be tested for matching by disconnecting them from the associated tuning capacities and successively connect-

*Member "X" Section, Union Village, Woonsocket, R. I. Radio 1JJ.

(Concluded on Page 46)

Concerning Amplified Absorption Modulation

By Severiano Justi*

MORE attention should be given to the method of modulation in which power is absorbed from the antenna system by the plate circuit of the last tube of a 2-stage or 3-stage amplifier. This will handle a bit more power than the usual 'loop' method in which the microphone itself must get rid of the power. At 2AB, the amplifier that I use is a common one. For an antenna loading coil, an 8-turn Cardwell 5 1/4" inductance is used. I found that, for best

Tests On Method of Voltage Feeding the Antenna

(Continued from Page 37)

was also quite satisfactory and I could see a perfect accordance with the theory.

The unilateral connection of the aerial to an intermediate circuit as seen in Fig. 1, has the advantage of working without

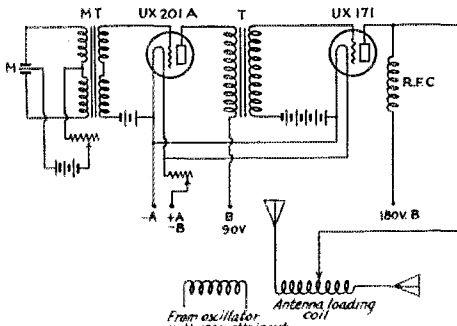

METHOD OF MODULATION

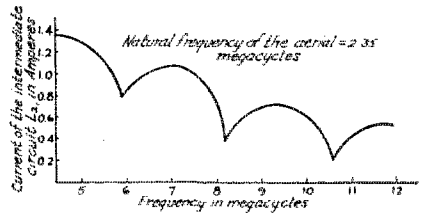

FIGURE 2

ground or counterpoise and with a great facility of tuning, because there are the simplest and clearly arranged conditions of tuning.

With two homogenous aerials, we could easily realize a so-called bilateral radiation.

modulation, the plate tap of the amplifier must be put exactly on the center of the loading coil. Unless it is there, the modulation will be very hard and difficult to understand.

I use a third harmonic aerial with a counterpoise of 1/3 the length of the antenna, in the opposite direction. When talking in the 'mike' there is no change in the wave and the antenna meter shows no movement.

The choke coil in the plate lead is made of 120 turns of 22 d.c.c. wire on a tube of 1 1/2" diameter.

I would like to try this system on BC waves but I can't, due to the prohibition by the government of phone even on short waves. In the diagram M is a two-button 'mike' such as the Kellogg or W.E. (if you can get it) broadcast variety. A single button mike can be used if a suitable open core microphone transformer can be found. In this case, MT is a Thordarson 'mike'. Transformer T is a General Radio 21 audio transformer.

*sb2AB, San Paulo, Brazil.

Strays

A splendid chart of the world has been published by the Hydrographic Office of the Navy Department showing great circle distances from Washington D.C. to all parts of the world. The map is, of course, accurate only for locations in Washington, but it would be of great value to amateurs in that general section of the country in permitting rapid approximations of distances covered. At a cost of twenty cents the chart can be obtained from the Hydrographic Office, Navy Department, Washington D.C.

The first of the branch offices of the Radio Division, Department of Commerce, recently authorized, has been opened at Buffalo in charge of an assistant inspector from the Detroit office. Examinations for amateur operator's licenses may be taken at the Buffalo office, but matters concerning station licenses will continue to be handled by the main office at Detroit.

A Simple High Frequency Oscillator

By William H. Christie*

BEING in need of a reliable high frequency oscillator for some experimental work, the writer tried out a modification of the circuit developed by Townsend and Morrell (*Phil. Mag.*, Aug., 1921) as used by Gill and Donaldson (*ibid.*, July, 1926) and was struck with the possibilities this arrangement holds for transmission on the five-meter band.

A search through my files of *QST* fails to reveal exactly this arrangement, so it is being passed on with the hope that some results will be obtained from it. The circuit is very stable and not tricky.

The inductances consist of two straight parallel copper wires, strips or tubing, about four inches apart, attached directly to the grid and plate leads of the tube, the outer ends being attached to a condenser.

In the writer's arrangement, copper tubing is used and a variable condenser has been substituted for the fixed one of the former circuits. This condenser has to withstand the full plate voltage. A good receiving condenser capable of withstanding this voltage will answer well for low power. A B.T. laboratory type condenser is being used by the writer with as much as five- to six-hundred volts on the plate. The B plus and grid return leads should be kept well away from the inductances.

The ordinary fixed condensers are very poor and no end of trouble was encountered until the variable was substituted. Since then no trouble has been met with and it allows, furthermore, a small tuning range.

Using an old Northern Electric five watter, minus the base, the 3.5-meter mark was easily reached, and although this seems to be the limit for this tube, the oscillations were quite strong.

Unfortunately, I am not a licensed amateur, hence cannot (hi!) test out the transmitting possibilities of this circuit, but from indications it seems quite efficient.

The length of the inductances will vary, of course, with the tube characteristics, but to give a rough idea of this dimension, the accompanying graph is given. This was obtained by starting out with an inductance about 75 centimeters long, measuring the resulting wavelength with the familiar Lecher wires, then cutting off two or three centimeters of their length and measuring again, until the limit of the circuit was reached.

It is a good idea to calibrate a wave-meter (if you have not already got one) at

the same time. A simple and suitable one may be constructed with two half turns of heavy wire attached to the rotor and stator plates of a 125- μ f. condenser, the outer ends being soldered to a 1½-volt flashlight bulb. Be sure the Lecher wires are not so close to the oscillating circuit that they appreciably alter the wave length.

It will be noticed that no r.f. chokes are shown, nor are they absolutely necessary,

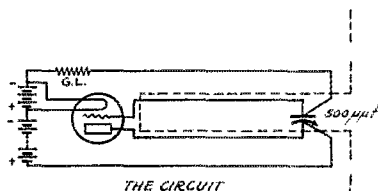

THE CIRCUIT

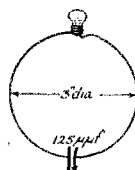

WAVEMETER

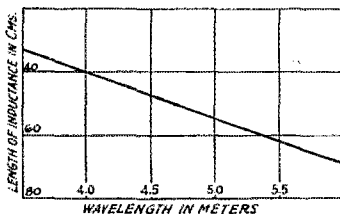

though their addition is preferable; in fact the grid leak is not absolutely necessary for low power, so that if any reader wishes to try out the circuit with an overloaded receiving tube or better still, a 'power tube', he may be sure of results without having to purchase material other than is found in nearly every junk box.

To couple this oscillator to the antenna, I might suggest using a copper tube one-half wave long, bent and coupled to the circuit as shown by the dotted lines in the diagram, as it is in this form, with the upper and lower halves parallel, that the power is tapped for the investigation for which the oscillator was constructed.

*Vancouver, B. C.

Reducing the Cuss-Quotient

By Jack Paddon*

PEERING out of a window with field glasses at a swaying antenna meter may be conducive of lumbago and hardening of the vocabulary, but seldom tells one anything about the antenna current. The lamp-in-the-antenna can be seen somewhat better but it is makeshift and haywire and unsatisfactory except at that intense moment when it yields 5,000 candle power for .0001 second.

The curves M_3 & M_4 tell how the transmitter can be adjusted to the antenna-and-feeder system but let's have words of one syllable to reinforce them. Never mind curves M_1 and M_2 —they are for the rich, and we'll talk about them later.

First tune the oscillator. We will beat the frequency-versus-wavelength argument by talking about dial readings. Starting at

this is "rich") as to own a pair of r.f. ammeters they can be put into the tank circuit and the feeder line, whereupon they will

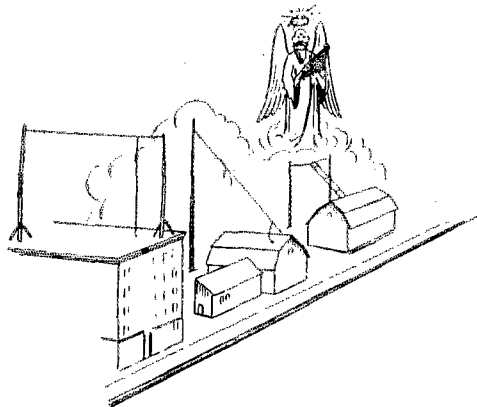
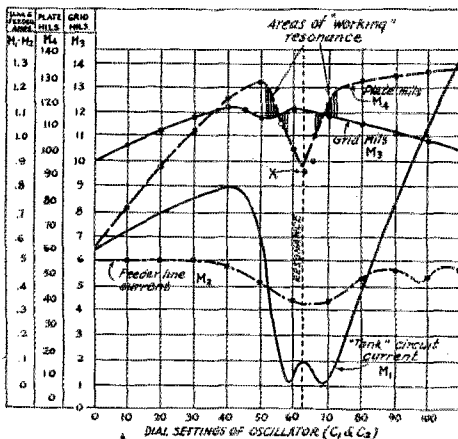

SHADE OF HERTZ REALIZES WHAT A LOT OF WEIRD THINGS ARE BEING DONE TO HIS ANTENNA

the low end of the scale tune upward. Referring to the map we see that grid mils and tank current promptly proceed in the general direction of N. E. by East while the plate current departs at standard speed on a N. E. by North course. Presently the grid mils falter, then the bottom drops out of plate current. When the plate mils are clear down at X we have resonance, which is completely n.g. for working. Beyond the resonance point the reverse of these things happens. The working point is where the plate current has slid about half way down. If you are so affluent (one syllable word for

CURVES SHOWING HOW TWO MILLIAMMETERS M_3 AND M_4 WILL TELL HOW TO ADJUST THE TRANSMITTER TO THE ANTENNA

If you are rich and have two ammeters they can be used to confirm the result as shown by M_1 and M_2 . The diagram suggests where the meters may be put. Of course any sort of oscillating circuit can be used and as far as we are concerned the feeder may have one, two or 5 wires.

bear out the above as shown in curves M_3 and M_4 . Note that curve M_1 is lowest of all at the points recommended for "working resonance".

Another cheap and positive indicator is to put an ammeter in the 110-volt line. When you have max. input you have max. output—probably.

We positively refuse to discuss feeder systems and antennas; it's all a matter of care in adjustment anyway. They will all work—short, long, high, low—or with the deuces wild.

Strays

McMinn of 2WC made 37 points in the International Contest which he believes will entitle him to a binding post or about eight inches of BX.

*2Lt. Sig. Res., Room 722, Morton Bldg., 108 N Wells St., Chicago.

A Mounting for Space-Wound Coils

By Guy E. Pigford*

I have read with interest accounts of various methods of 'air supporting' coils, notably that of Mr. Bennett in the November, 1927 issue of *QST*.

Inasmuch as the coil form is some trouble to get made and as not many of us have a lathe at our command, I would like to suggest that a round pint bottle from the drug store will serve the purpose admirably.

Get a bottle having an outside diameter of $2\frac{1}{2}$ or $2\frac{3}{4}$ inches depending upon the size of coils desired. Wind this bottle with a single layer of number 16 or 18 hard twist linen fishing line; not wrapping twine. Lay three or four strips of celluloid on the layer of line and stick the ends down with cement. After this is hard go ahead with the winding process as suggested by Mr. Bennett.

MOUNTING THE COILS

The coil mountings that I am going to describe are probably in use by a good many men but I have been in many shacks and most fellows are using Fahnestock clips or binding posts and changing coils is a laborious task. And leaving out the time element, the coils are not as steady and rigid as would be desired.

To make these coil mountings obtain as many UX tube bases as you desire coils. I am speaking of the new type bakelite base with the long prongs. Draw a line around the tube base $\frac{3}{8}$ inch from the bottom and cut it with a hacksaw. It will be necessary to hold the base in a vise (by clamping the bakelite and not the prongs as they are liable to bend and not fit into the socket after completion). Cut two strips of bakelite $\frac{1}{4}$ inch thick and $\frac{3}{8}$ -inch wide, long enough to reach from the outside of the plate coil to the outside of the grid coil after proper allowance is made for coupling. Be sure these strips are bakelite and not hard rubber as the rubber will bend too easily to make a rigid mounting. Open up the prongs of the tube base by holding it firmly in one hand and applying a soldering iron to a prong. When it is hot, swing the base with a sweeping motion of the hand, and you will flip the solder out neatly. This is easy to do but hard on the O.W.'s rug. Better take it out on the back porch.

Assuming that you have figured out the required number of turns for the grid and plate coils, bend the coil ends of the grid

coil so that it will slide down into the base with the ends through the prongs without twisting out of shape. Fit the plate coil ends into the smaller prongs and the grid coil ends into the larger prongs. Slide one strip between the coil and the base and lay the other through the coil to bind the whole works down. Mark the exact cen-

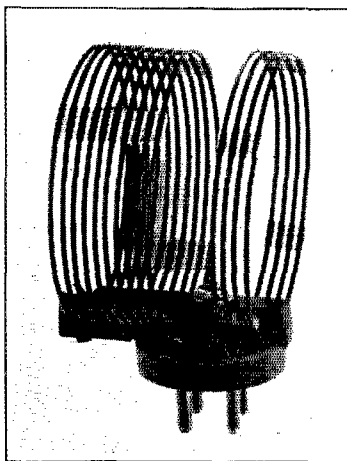

ONE OF THE COILS ON ITS "UX" BASE.

ter of the tube base and the point where the strips rest over the center of the base. Slip out the coils and strips and drill a hole through the strips and the base to take an $8/32$ bolt.

Assemble the coil again and pass the screw through the base and the strips and screw down tightly enough to keep the coils from moving. With a sharp pointed instrument, mark the point on the strips where each wire in the coil rests and mark the point on the base where the strip rests. Take the coil apart again and with a three-cornered file cut a shallow groove across the strips corresponding with the points marked for each wire. Also cut a notch in the tube base where the strip will rest to keep it from twisting around when the coil is completed. Your coil and mounting is now ready for the final assembly. Just before bolting it down flow a few drops of cement down the grooves where the coils will rest and screw down tightly. Leave the coil alone until the next day and then solder the prong ends. This cement is inflammable so do not monkey around it with a hot iron or open flame.

*4EC, Box 418, Red Springs, N. C.

This coil when completed can be plugged into any of the sockets on the market but of course you want one that can be screwed down tightly. Some of them are set on springs so the tube will be cushioned. This type is unsatisfactory as a coil socket. I have found that a Kelford socket has a screw through the center and that it can be tightened down solidly, making an excellent socket for this.

If these coils are to be used in a circuit in which the antenna is coupled by a small condenser the job is complete. If it is desired to use an antenna coupling coil some little extra work will be necessary. Wind this antenna coil out of number 20 cotton covered wire on a smaller bottle or form. Do not space wind it or put celluloid strips beneath it as in the other coils. Just wind it close and even. Flow the cement over it so as to completely cover the outside of the coil. Let it harden for a day and you will find a very rigid coil. This one should be about ten turns. Take a flat strip of bakelite $\frac{1}{4}$ -inch thick and $\frac{3}{8}$ -inch wide and 2 inches long. Cut a slot in the end deeply enough to receive the coil and still leave enough of the strip to drill a hole through the end for a small bolt. Drill a hole through the other end of the strip that will take an 8/32-inch binding post. Now mount coils and socket on the baseboard of the receiver and cut a block of wood just high enough to place the antenna coil in the end of the plate coil. Mount a binding post on this block, slip the strip holding the antenna coil over the binding post and tighten down. This antenna coil can then be varied by swinging it from side to side.

If reasonable care is taken in the construction of these coils and mountings, you will have something to be proud of and some coils that will stay with you for a long time provided good heavy wire was used for the coils. In my case, number 15 enameled wire was the most satisfactory.

A Resonance Testing Method

(Continued from Page 41)

ing across each one a suitable fixed capacity. With the same shunt capacity, the coils should resonate to the same frequency. Condensers may be tested in a similar manner by employing a suitable fixed inductance.

The minimum reading of the grid meter at resonance is dependent upon the size of the transfer capacity, the wavelength at which the measurement is taken and the resistance of the circuit under test. For a number of similar circuits, tuned to the same wavelength and with a definite transfer capacity the dip of the grid meter at resonance should be the same for all cir-

cuits unless the resistance of the different circuits varies. It is quite common practice among manufacturers to use small tuning coils wound with very fine wire. Sometimes these coils receive a "nick" which causes a short between turns. While the resonance of the circuit will not be greatly affected, the radio frequency resistance of the circuit will be very high and cause a loss of volume. This will be detected in the usual testing procedure because the grid-meter needle will not dip as much as with the other circuits. Some types of receivers employ a volume control which affects the resistance of one or more of the tuned circuits. The resistance should be cut out as much as possible when making a resonance test.

Some receivers employ a device to compensate for the antenna tuning effect. When testing such a circuit it is only necessary to note that resonance is within the range of the compensator.

The following points should be observed to increase the accuracy of the tests. Keep the geometry of the general layout the same for each test. The r.f. line should lead directly away from the set and should not come close to the shield or any grounded object. The size of the transfer capacity should be kept as small as possible. While the tests can be made with or without the tubes being in their sockets it is more conclusive if the tubes are in place. One reason for this is that the detector tube sometimes does not have the same loading effect as the other tubes. Be sure that none of the tubes used during the test have displaced elements! You know why!

Strays

LIKE, observing his three months old heir QSO the Pyrex nursing bottle, had the bright thought that such bottles (8 ounce size) costing one quarter, would make excellent stand-off insulators if fitted with a simple clamp at the bottom by means of which they could be attached to the wall, table, or what have you.

Some 'light' on radio transmission from *Winged Defense* by General William Mitchell (G. P. Putnam's Sons, 1925).

'Light also interferes with our radio or wireless telegraph and telephone communication. Radio waves are really elongated light undulations, and whenever there is light in the air we hear some of the overtones and undertones from it. That is why the best time for radio telegraphy is at two or three o'clock in the morning, when all the light has gone out of the Air and before more light has come.'

Kennelly, Taylor and Rice please note.

The Communications Department

F. E. Handy, Communications Manager
1711 Park St., Hartford, Conn.

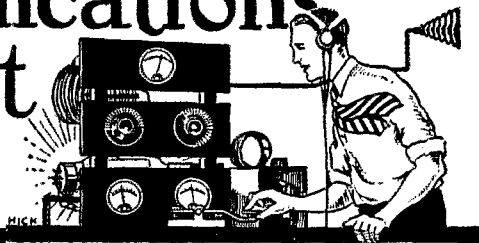

SECURITY OF MESSAGES

Someone recently approached us with the proposition that they thought it possible to copy messages and do what they liked with the contents just as long as they were not a licensed operator, sworn to the oath of secrecy. Not so! The point is covered by Section 27 of the Radio Act of 1927 which is abstracted herewith for the information of all who may read.

"No person receiving or assisting in receiving any radio communication shall divulge or publish the contents, substance, purport, effect, or meaning thereof except through authorized channels of transmission or reception to any person other than the addressee, his agent, or attorney, or to telephone, telegraph, cable or radio station employed or authorized to forward such radio communication to its destination, or to proper accounting or distributing officers of the various communicating centers over which the radio communication may be passed, or to the master of a ship under whom he is serving, . . . ; and no person not being authorized by the sender shall intercept any message and divulge or publish the contents, substance, purpose, effect or meaning of such intercepted message to any person; and no person not being entitled thereto shall receive or assist in receiving any radio communication and use the same or any information contained therein for his own benefit or for the benefit of another not entitled thereto: *Provided*, That this section shall not apply to the receiving, divulging, publishing, or utilizing the contents of any radio communication broadcasted or transmitted by amateurs or others for the use of the general public or relating to ships in distress.—F. E. H.

TRAFFIC BRIEFS

The new Assistant to the CM, 9DOA, arrived in Hartford on Memorial Day and has been on the job ever since. Work on the International Tests has occupied most of his time. Nearly all of the reports from foreign amateurs have been checked. The wind-up of the International Tests will be reported in the August issue of *QST*. Everybody have patience, please!

nubKS, oh6DB, and oh6NL have been handling traffic for the trans-Pacific Yacht Race of June third. Three of the yachts were equipped with radio.

The Dayton Amateur Radio Club of Dayton, Ohio, staged a hamfest on May 5 and 6. Delegations of hams came from Ohio, Indiana, and Kentucky. About two hundred were present and enjoyed talks by SCM Angus, 9CYQ, of Indianapolis, by Mr. O'Callahan of the U. of Cincinnati, by Lieut. Macready of cross-country and altitude flight fame, and by Lieut. Roberts, op1HR. At the banquet the gang enjoyed "CQ" ice cream. A code contest was held, and \$150.00 worth of prizes were awarded.

160-METER CODE PRACTICE

The response to our little squib in May *QST* was very gratifying. An equal number of volunteers and beginners have written for instructions and information. Material has been prepared for the purpose of enabling beginners to get up to 160 meters. This and a list of schedules will be furnished to beginners who request it. More volunteers are needed. If you can help any, OM, we suggest that you read again the article in the C D section of May *QST*, and write to us.

Q S T FOR JULY 1928

Don Mix Flies

THE co-operation of every amateur is needed in the preparation for a proposed 'round the World flight in which our old friend Don Mix will be operator. This one is going to be interesting, we promise you. We have the following information on the radio equipment, which is being supplied by the Burgess Battery Co.: There will be a crystal transmitter on 20.26, 40.52, 76.8, 34 and 68 meters. The oscillator will consist of a 112 or 171 and the power amplifier a 310. For emergency use it will be possible to shift the 310 over as an oscillator for additional power. In the event that crystals are broken, separate tuned circuits are being supplied to take the place of them and operate in the amateur bands. A 600-meter transmitter will use two 7½ watt tubes as straight oscillators to operate either c.w. or i.c.w. No phone transmission will be made. Receivers will be provided for all transmitting waves. Power will be taken entirely from dry cells.

The plane to be used in this flight has been especially designed to give the greatest possible safety factor. It is of extremely rugged construction, especially the hull, in order to withstand severe battering if forced down at sea. It will be equipped with two Comet motors each of 150 h.p. Simple but efficient landing gear, enclosed cabin, motors mounted on the wing to provide for clearing obstructions and waves, and for maximum propeller efficiency, are other features.

The route of the plane will be from west to east, starting from Detroit, and passing through Newfoundland, the Azores, France, Germany, Russia, Siberia, Alaska, and Canada. There is going to be no haphazard flying because the purpose is to demonstrate the practicability of commercial flying around the world.

The plane is to be delivered at Madison, Wisconsin, some time during the latter part of June. The Burgess Company will have it for a week or so, during which they will make tests on the radio equipment. These tests are designed so as to be interesting to amateurs, for the fullest amount of co-operation is needed. With Don Mix, W. H. Hoffman, Phil Zarian, and Fred Schnell behind them they can't help but be! There probably will be an all-night flight or an all-day-and-all-night flight. We don't know the dope on the plane's call yet—this and the information as to the exact dates of the test and of the commencement of the world flight will be sent out by Official Broadcasts just as soon as we get it. (Ed. note, These airplanes don't always get out on sked time, so don't feel bad about the "latter part of June" mentioned above. Just watch the OBC's.)

There you have it. 'Tis a chance to do some worth while work, and it's bound to be interesting. QRX for OBC (especially 1MK), OM, and when the fireworks start, send the into to HQ. Tnx.—L. R. H.

Considerable confusion seems to have arisen over the new "VE" which the Canadians have been using with their calls. This is *not* a new intermediate, but is one of the provisions of the 1928 Conference being carried into effect earlier by the Canadian authorities. By Jan. 1, 1929 (perhaps earlier) all amateur stations of countries ratifying the provisions of the Conference will be calling and signing after this fashion: KA VE9AL VE9AT, VE9AL de W5AF W5AF W5AF AR. The Federal Radio Commission has not announced the common first letter or letters for United States amateurs yet. Yes, OM, pretty soon you'll have a definite prefix to your call that will stamp you as a U. S., Canadian, Australian or what-not, every time you sign.

BRASS POUNDERS' LEAGUE

Call	Orig.	Del.	Rel.	Total
6ARD*	5	10	738	753
7YK	575	—	6	581
op1HR	159	155	258	572
1MK	148	152	221	521
9AIN	67	58	384	509
9EZ	96	212	168	476
6AMM	111	287	62	460
6DKD	446	—	—	446
6AJM	45	25	292	362
6CGM	42	89	156	287
7AKK	3	1	274	278
op1DR	145	119	20	274
8DHT	39	30	199	268
4CK	209	34	16	259
6ADH	153	91	12	256
9COS	27	36	186	249
6CFQ	169	51	14	234
8AVB	62	8	156	226
8DDF	31	27	172	226
3AKB	19	47	159	225
6ZBJ	9	22	194	225
8AFG	66	73	81	220
9DLD	14	35	156	205
1MX	51	4	146	201
6BPO	42	102	48	192
9FGD	61	50	46	157
5JY	52	59	43	154
5HR	64	86	—	150
7KO	31	52	52	135
op1DL	68	52	4	124
6HWI	32	63	18	113
1BIG	43	62	—	105

* Non-amateur "amateur" station. See editorial, June QST.

6ARD heads the list by virtue of relaying a bunch of traffic. 7YK is second in line with the traffic originated at a "radio show" station. op1HR, 1MK, and 9AIN, all consistent B.P.L. stations all handled well over 500 messages, and as usual stand at the top. All the stations appearing in the Brass Pounders' League are noted for their consistent schedule-keeping and reliable message-handling work. 6AMM, 6AJM, op1HR, op1DR and op1DL win their places in our honor roll by handling quantities of long jump traffic regularly—which is a slightly different proposition than some of the short-haul work. Special credit should be given the following stations responsible for over one hundred DELIVERIES in the message month: 6AMM, 9EZ, op1HR, 1MK, op1DR, 6BPO. Deliveries count!

A total of 200 or more bona fide messages handled and counted in accordance with A.R.R.L. practice or just 50 or more deliveries will put you in line for a place in the B.P.L. Why not make more schedules with the reliable stations you hear and take steps to handle the traffic that will qualify you for B.P.L. membership also

**No. 803 WNP June 1, via ISZ to A.R.R.L.
Hartford, Conn.**

The Bowdoin freed herself from the ice this morning June first. She now floats in a pool of open water, surrounded by the melting harbor ice which is fast breaking up. We expect Anetalok Bay to be clear of ice by the middle of June.

May was a month of rather patchy communication. 8AFA being the only station worked consistently throughout the month. Brooks of 9AFA handled nearly half of our message total of 213. The other messages were scattered among a number of stations notably IGA, ISZ, 1MX, 1BMS, 2VI, 3AKW, and 8ANK. We lost the help of a mighty good operator when 1BMS left on a training cruise early in the month. Conditions changed here during the month so that first district stations were noticeable by their absence. Into this gap 3AKW and 8ANK stepped handily and helped greatly with eastern traffic. These two boys also know how to operate. Best time for QSO with WNP is in the late afternoon and early evening as it used to be last summer. Believed four to eight PM EST will remain good period for 20 meter work with us for the remainder of our cruise.

Following 20 meter stations exchanged signals with WNP during May: 1ahx 1alb 1amc 1awe 1bat 1bke 1bms 1bxh 1cd 1ga 1ka 1mr 1mx 1sz 2arb 2arx

Zaud 2biq 2bms 2ctb 2gp 2sb 2aj 2vi 2adm 2ahr 2aih 2akw 2ank 2bmc 2bwj 2cbk 2nr 2adg 2afe 2agw 2ank 2aw 2bwj 2ccl 2cfr 2cmh 2cnt 2cvj 2lf 2nb 2afa 2bgq 2che 2cvd 2dce 2dwe 2eal 2eyu 2fag 2fbw 2fgo 2e3bc 2d-7jo 2f-8fr 2f-8grg 2f-1fp 2f-1gw 2f-1wsg. Calls worked left out of March list: 1adw 2avv 2bhf 3ld 9bkh 9evb 2f-8cp 2f-1mly. Best regards. Himoe

There is to be an interesting plane flight from Rockford, Ill., to Stockholm, Sweden. The plane is a Stinson-Detroiter with call KHAH. QRH's of 94.20, 47.84, and 23.62 meters. The flight is supposed to start in the first week of July.

The Dyott Expedition in South America has relayed most of its traffic via sb11B, nu8CFR, and nu2TY.

VOQ, the S. S. *Morrissey*, was worked by 6DFV on May 26th on 20.1 meters. Signals of VOQ were RI-2. 6DFV was reported as R4. More reports will be greatly appreciated. 9OR of Omaha, Neb., has a schedule with VOQ (31.3 meters) on Mon., Wed., and Friday at 11 p.m. C.S.T.

If you hear VSGR you'll know that it's the Royal Canadian Mounted Police patrol boat *St. Roch*. She left for Hershel Island on June 16th, and contains short wave equipment for operation between ten and eighty meters. The official QRH is 23.4 meters. F. W. Sealey, the operator, says that Hershel Island is located approximately at 70 N. Lat. and 140 West. Long., and that he'll be tickled to QSO amateurs.

The United States Coast Guard is sending a small expedition up along Labrador and Greenland for the purpose of measuring terrestrial magnetism. At the time of preparing copy no information on the name of the ship or its call letters had been given us. We do know, however, that the outfit will be equipped to do amateur work on the following schedules in E. S. T.: 8:00 to 8:30 a.m., 12 noon to 12:30 p.m., and 4:00 to 4:30 p.m. on 24 meters; 8:00 p.m. to midnight on 36 meters. The ship will leave Washington about July 1. Watch the Official Broadcasts and next QST.

1MK

THE following schedules have proven to be the most reliable. If you find it inconvenient to work 1MK directly, traffic given to the stations listed below will go through in good shape. The time given is Eastern Standard:

- 1APL (80) Sun., 7:00 p.m.
- 1AHV (80) Mon. and Fri., 7:30 p.m.
- 1BQD (80) Mon. and Fri., 9:00 p.m.
- 1VB (80) Tues. and Fri., 7:45 p.m.
- VE2BR (40) Sun., 9:45 p.m.
- 2CTM (80) Mon. and Fri., 9:30 p.m.
- 1BIG (80) Mon. and Fri., 7:00 p.m.
- 3ZS (80) Mon. and Thurs., 7:45 p.m.
- 3QP (80) Mon. and Thurs., 9:45 p.m.
- 4XE (80) Sun., 7:30 p.m.
- 4IE (80) Thurs., 11:00 p.m.
- 6SV (40) Mon., 11:45 p.m.
- 6BWH (40) Tues., 12:30 a.m.
- 8EY (40) Wed., 12:30 a.m.
- 6CIS (40) Fri., 12:30 a.m.
- 6ZD (40) Wed., 1:30 a.m.
- 8AAG (80) Sun., 7:45 p.m.
- 8AYB (80) Tues., 11:30 p.m.
- 8DED (80) Tues. and Thurs., 9:30 p.m.
- VE9AL (80) Tues. and Fri., 7:15 p.m. (ve9AL on 52.5 meters)
- 90X (80) Sun. and Thurs., 11:30 p.m.
- 9ENM (40) Mon. and Fri., 11:15 p.m.
- 9APY (80) Tues., 9:00 p.m.
- 9DGA (40) Fri., 11:45 p.m.
- 9DNG (40) Mon. and Fri., 11:00 p.m.
- 3XI (40) Mon., Fri., 11:30 p.m.
- WSBS (40) Sun., Mon., Tues., Thurs., and Fri., 8:10 or 8:15 p.m. (WSBS on 33.2 meters).

Periods of general operation have been arranged to allow the whole League membership a chance to QSO HQ. The simplest way to get them across understandably seems to be to list them under forty meters and eighty meters. Here they are:

EIGHTY METERS:
8:10—9:00 p.m. on Sun., Mon., Tues., Thurs., and Fri. This general period follows the OBC, which is sent at 8:00 p.m. Also, WSBS is worked following the OBC, whenever possible. See WSBS sked above.

10:00—11:00 p.m. on Tues. and Thurs.
12:00 p.m.—1:00 a.m. or later, on Sun, night (Mon. morning).

FORTY METERS:

10:10—11:00 p.m. on Sun., Mon., and Fri., This general period follows the 10:00 p.m. OBC.

12:00 p.m.—1:00 a.m. or later, on the following nights; Mon., Tues., Thurs., and Fri. This general period follows an OBC *only* on the nights of Tues. and Thurs.

R. B. Parmenter, as most of you know, is the chief operator at 1MK, and signs "RP". Other signs which will be more or less familiar in the future are "OU" of Louis R. Huber, the Ass't. to the Communications Manager; "FH", of F. E. Handy, the Communications Manager; and "AH", of A. A. Hebert, the League's Treasurer and Field Man.

QRH of 1MK, as announced previously, is either 83.86 or 41.93 meters (3575 kc. and 7150 kc.).

Official Broadcasts are sent from 1MK simultaneously on 41.93 and 83.86 at the following times:

Sunday, Tues., and Thurs. at 8:00 p.m. and 12:00 p.m. (midnight) *Eastern Standard Time.*

WSBS

THE Yacht *Carnegie*, WSBS, of the Department of Terrestrial Magnetism, Carnegie Institute of Washington, left Newport News, Va., May 10 bound for Plymouth, England, the first lap in its three and one-half year world cruise. At this writing we are able to report the safe arrival of WSBS at Plymouth. By the time this is in print the *Carnegie* will be QRD Hamburg, Germany and after a couple of weeks at that port it will be off again—this time for Iceland. For the past week or two "LJ" has reported many good QSOs with European stations. Some of us have had many delightful contacts with operator "LJ" of WSBS. A number of stations deserve credit for helping the expedition. In return for working an expedition regularly, one is well repaid for the fact that the progress and news from the expedition enable one to visit the far places and go through many interesting experiences by proxy. It certainly is thrilling to listen to WSBS night after night—to check the daily position on a map, noting the excellent time made in good sailing weather—the slower progress when becalmed or delayed by fogs, gales or headwinds—to note the crystal controlled signals vary in intensity when the ship is rolling badly in storms—to picture the discomforts of operating with several inches of water in the operating room—then with relief to see the first English light-house from the *Carnegie's* radio shack and to enjoy with "LJ" the thrill of seeing land for the first time in a whole month. "LJ" has reported that even with his screen grid receiver, he can hear but few U. S. hams at the time of day he schedules 1MK (0100 GCT). A few hours later (0400 GCT) signals go up to R-ten plus and the whole 40-meter band sounds as though "LJ" were right in Hartford instead of at Plymouth, England. The report received by radio (WSBS to 1MK) tells the story and gives credit to the stations communicating with and assisting the expedition.

"Yacht *Carnegie*, WSBS on 40 June 9

"To A.R.E.L. Hartford, Conn.

"Not much to report this first month out. Forty-meter band at night sounds same in England as it does in U. S. A. with 1MK among the outstanding signals. Operation here limited and no effort made to reach great traffic totals but fair number of messages handled and all more or less worthwhile. Radio weather during month very consistent except for couple of days when things were pretty dead. Have heard little on 20-meter band and nothing on 10. 9045 and 6574 (kilocycles) (33.2 and 45 meters) have been used mainly. On 6574 have QSO'd a bunch of 'eg'. eg5SH, eg5WQ, and eg2XY deserve thanks for doing us a couple of favors. You know how well 1MK schedule has worked out. Arriving Plymouth now and probably be here a week or so. Calls worked as follows: 1akd 1cmf 1mk 1om 2aib 2auo 2ps 2uo 2wi 3anh 3bsh 3ef 3kj 4ej 4oc 4si 5ayl 5bj 6ax 6bzf 6wn 7ac 7vq 8hbz 8bjb 8brq 8eq 8oq 9aeb 9avz 9cd 9da 9dng nm-9a ef-8jc ef-8jf ef-8rgw eg-2un eg-2xy eg-5lv eg-5sh eg-5uf eg-5wq eg-6pp eg-6rb eg-6yl ve8ca ef-wf scp nkf. Hope to add to list next month. Cheerio.—L. A. Jones, Radio Op., Yacht *Carnegie*, WSBS"

—F. E. H.

The Ten Meter Tests

AS this report is being written (June 8) it appears that there is being a gradual return to good conditions on our ten-and twenty-meter bands. The unsettled and rainy weather of middle May seems to be in some way connected with the unexpected "dead" period which obtained. It is estimated that more than one hundred stations took an active part in the tests. The ardor of the "ten-meter gang" was by no means dampened by the weather. Several men investigated local transmission conditions about their ten-meter stations using a portable receiver and cruising about in automobiles. Local work was carried out between ten-meter stations in numerous cases, the ground wave coming through well at varying distances under thirty miles. Conditions were pretty terrible on May 19 and 20 and nothing but local work was reported. The following week, conditions over the western part of the United States improved somewhat so that some DX work was reported from several sources.

The star stations as far as DX was concerned were 9EF (Hammond, Ind.), 6DHS (El Monte, Calif.), 6BZF (Sherman, Calif.), and 6AM (Long Beach, Calif.) 9EF worked 6DHS on May 26 from 2:20 to 2:45 pm and from 3:30 to 3:45 pm. 9EF R8 steady and easy to copy, 6DHS R6 and nice to copy. At 3:45 pm the same afternoon another 100% QSO took place between 9EF and 6BZF. No fading or swinging of any kind was present and 9EF was reported R6 and very steady. Sunday, May 27 at 3:55 pm. 6AM answered a CQ from 9EF and once again ten meters scored a success. 6AM was R8 with RAC note and he reported 9EF R9 on screen grid receiver. Before the communication, 6AM's signals had been copied for about an hour, at 9EF. After a good chat with 6AM it started to rain in Hammond, Ind. and the signals faded clear out. These QSO's show very definitely that contact between the central part of the country and the west coast is entirely feasible on ten meters. 6AM copied 9EF (R8), 6BZF (R6) and 6DHS (R6) on May 26 and in addition to the QSO with 9EF on May 27, 5TO (Arkansas Pass, Tex.) was copied. At 9EF, an 852 was used in a split Hartley with 190 watts input. The transmitting antenna at 9EF was a 40-meter Hertz energized at it's fourth harmonic. 6AM and 9EF both observed that no ten meter results have been secured on cloudy or foggy days. 6AM's set put out 400 watts (input unknown to us) into an antenna 70 feet high and 62 feet long, current fed at the center by two r.f. feed lines 65 feet long. 9EF believes that international contact will be possible on this band with a minimum of power. He says, "Let's have another DX party on ten meters. The fun has only started. Have tried QRP and in every case the signals are practically as loud. This gives the boy with the 210 as much of a chance as the one with a bank of 204s". The operator of S. S. *Elisha Walker*, KDGQ reported from Aruba D.W.I. that nothing was heard on "ten" May 19 and 20. "LJ" of WSBS reported about 700 miles west of Plymouth, England. No other foreign reports worthy of note have been received since the tests.

2TP (Leonia, N. J.) worked six stations and heard six different stations thus making the highest score (36 points) of anyone reporting participation in the tests. 2TP holds the record for DX reception in these tests. He copied both 5JT (Houston, Tex.) and 6AM. The reports have it that both stations were R6 to R7 at times, their QRH 11.5 to 12 meters.

The list of QSO's is as follows: 2JN, 2AQB, 2ACN, 2AHO, 2SY, 2BHA. Those heard but not worked: 2NM, 2GP, 2EB, 2VA, 5JT, 6AM. 6AM was heard from 5:20 pm EST until 8:30 pm (R5 with QSS after dark). 5JT was picked up at 5:30 pm. 2TP will continue to test Sunday on 10.5 meters between 9 am EST and 4 pm EST. A regular 3 circuit tuner with two a.f. stages on a 65 foot antenna was used. Congrats on the good work, 2TP.

2BHA (Nutley, N. J.) made the next best score (thirty points). He worked 2TP, 2JN, 2SY, 2AHO and 2ACN and heard 2EB, 2NM, 2CZR, 2AQB and 2AOJ working on the ten meter band. He says, "Previous to these tests eSCT had been coming in here and at 2JN R6 at noon. I believe when weather conditions are more favorable we will be able to work across OK." 2ACN (Palisades Park, N. J.) worked 2TP, 2JN (25 miles), 2AQB, 2NM and 2BHA and copied signals from 2SY, 2EB and 2BRB making 28 points. He reports that foreign DX on 20-meters has been nil for both Sundays of the tests, a most unusual condition. 2SY (Bloomfield, N. J.) was QSO several second district stations and reports with his best

wishes for the next tests. SSG-RCBN (Denison University, Granville, Ohio) was on the air continuously during the ten meter tests except for listening periods starting at midnight on the 19th and ending the watch at midnight on the 20th according to the log submitted by operator C. M. Brelsford. An unidentified station was heard at six pm May 19 and communication was established with a point $\frac{3}{4}$ mile from the transmitter on ten meters.

1BVL (Dorchester, Mass.) was QSO 11A, 1N9, 1CPB, 1XM and 1ZZ and he also heard 1MR and 1ML running up some 27 points. He says most of these stations will continue on "ten" every Sunday. Automobile and airplane engine ignition QRM was noted in addition to the signals. 1CD (Lynn, Mass.) worked 8BDP (Fairmont, W. Va.), 4IO (Atlanta, Ga.) worked 4PX also of Atlanta. 6AJI heard 6AM. 3ZT listened especially for 1XM but his patience went unrewarded. 5RG (Dallas, Tex.) copied VE3CS (London, Ontario) and 6AM on May 27. VE3CS sends a fine report and says, "Am QRX for ten meter skeds with any of the gang. I am going to stick with ten until it opens up again as it surely will. Am arranging a sked with c6GYQ and would be glad to have anyone write me as always QRV." VE2AC (Thetford Mines, P. Q.) heard two stations but could not identify them through his local power leak. 1SZ (Hartford, Conn.) was in communication with 1AVK (South Manchester, Conn.) during the tests but reports no other results. Both 1SZ and 1AVK were heard by "RP" at 1MK thru airplane ignition QRM. 1AQD (Livermore Falls, Me.) tried hard but heard nothing. 2BRB (Brooklyn, N. Y.) has been on 10.25 meters almost every Saturday and Sunday afternoon with 500 cycle modulation and crystal control with 210s and a 203A P.A. A 115-meter cage working on one of the higher harmonics is used. 2JN and 2GP were worked before the tests and 2NM and 2AOL during the tests. 2EB, 2ACN and 2JN were heard in the tests but not worked at that time. H9XF (Madeleine Moret, Avenue Eglantine, Lausanne, Suisse, France) transmitted May 26 1120 and 2115 Greenwich and May 27 1500 to 1835 Greenwich requesting reports and listening on ten meters. We shall be glad to forward any reports on foreign ten meter stations.

Before the tests and since the tests some interesting reports were received which should not be overlooked. 1BVL worked 1CD (15 Miles) on May 13 from noon to 12:50 pm. 1CD was R4, 1BVL R6, 9EF heard 6DBO (Raymond, Calif.) and 4CK (Miami, Fla.) a week or so before the tests. Between April 24 and May 24, 6ANN (Long Beach, Calif.) heard 1ANA, 2EB, 2NM, 2JN, 5AUZ, 8ALY, 8CSR, 8EX, 8CVO and 8AHK and also during this period he worked 8EX, 8CSR, 8ALY (R4 as late as 4 pm PST) and 2JN. It is believed that the QSO between 6ANN and 2JN at 1745 GCT April 29 is the first truly transcontinental two-way work on ten meters. With his report 6ANN expresses the hope that the dead period will wear itself out so that we may continue without experimentation. 1BIG, 1AQD, 4CF, 4AGE and 5HE reports nothing heard on ten meters during May. 1AQD suggests for those having trouble in finding the ten meter band the use of the harmonics from an r.f. driver which is adjusted by means of the regular wavemeter. 1AQD and 1BIG are running daily tests between 12:45 and 1:15 pm EST. 1CFO is another ten meter station in Maine. On June 3, 1BIG (Augusta, Me.) reports hearing 2EB and 2ACN. The latter station faded quickly but 2EB was heard most of the afternoon. On the same date 1CGX (Bristolboro, Vt.) heard 9EF at 11:15 am EST R7 and very steady. RAC note. Corporal Edward J. Day at Fort de Lesseps (WUGC) Canal Zone has been listening on ten meters and will give us further reports. oa2RX (H. C. St. John, Rockdale, N.S.W., Australia) reports via 9EF that he is standing by each Sunday from 2400 to 0200 Greenwich listening for ten meter signals. 9EF is also arranging some ten meter tests with him. We understand that GUF was handicapped by a bad power leak and so unable to participate in the tests but this should be remedied long before this is in print. 4UU (Concord, North Carolina) copied 2BVG and 8DSA on May 10 and succeeded in hearing 1CD and 1OM on May 13. 5HE is on ten meters every Sunday morning and afternoon with 150 watts input to a UX852. On April 29 5HE worked 1AQD.

MORE TESTS

The amount of interest being shown in ten meter work is on the increase. This interest and the successful results and information obtained in and about our first ten-meter tests is most gratifying. Most of those

reporting suggest and request another test to be held at the earliest possible date. It seems to have been proved pretty definitely that the weather conditions are important. Every Saturday and Sunday brings word of some new results. It is really easy to build a new plug-in coil for the receiver and to get the transmitter to QSY to the 10-meter band with almost any of the ordinary circuits. As time passes, more and more foreign experimenters and brother hams are getting sets going in the ten meter band.

Let us continue the weekly Saturday and Sunday work then through the month of July and get ready for another big test in August. To cover all possible weather conditions and to obtain a comparison of results at different places on the different dates we have decided to make this test cover three week-ends. By announcing the dates at this time, QST can reach localities outside the U.S.A. and Canada so that this can be a really worldwide ten meter test in which there will be a good chance of some international QSOs on ten meters for all those who take part.

Everybody, everywhere, is requested to get busy and to prepare for the next ten-meter tests which will be held AUGUST 11-12, AUGUST 18-19, and AUGUST 25-26. All amateurs everywhere are cordially invited to take part and send logs and reports to A.R.R.L. Headquarters, Hartford, Conn., so that the results may be compiled and appear in QST. All that is necessary to take part is to get on the air, transmitting and receiving also if possible, or listening for the transmitters if you do not have the facilities of a sending station, and in any case reporting your results and describing your equipment. Let's go!

ARMY AMATEUR NOTES

FIRST CORPS AREA: Lieut. D. S. Boyden, 1SL, and the Corps Area Signal Officer attended the New England Division Convention of the League.

SECOND CORPS AREA: David Talley, 2PF, reports that 8DME is rebuilding, and has also joined the Naval Reserve. 2EV has left for the west coast. 2CZR will take his place as 2BCB. 2AY has been appointed N. C. S. of Orange County Net. 2BHY came to life and will act as alternate N. C. S. of Long Island Counties Net in place of 2BA. 2AWU, 2KR, and 2APV have come to life. 2AGS still acts as N. C. S. of Kings County Net. 2CP, 2JG, 3ZL, 2AT, and 2AOS have kept the New Jersey State net schedules in fine shape. Many of the Army-Amateur operators attended the Army-Amateur meeting of the Hudson Division A.R.R.L. convention on May 26. 2SC, the Corps Area C. S., is being moved over to Fort Wood on Bedloe's Island. 2PF will take its place during the move. It is planned to discontinue the regular net schedules during July and August and only keep schedules with those stations that so desire.

Capt. Treest, the Liaison Agent at Fort Monmouth, reports that 467 messages were handled in the Western New York Net, and that fifty messages were handled in the New Jersey Net. All net control stations or their alternates have kept schedules in the Eastern New York Net.

THIRD CORPS AREA: The following amateur stations have been successful in maintaining schedules with the net control station: 8BPD, 8GI, 3CEL, and 3EN.

NINTH CORPS AREA: First Lieut. Brooke McGown asked for relief and is being replaced by Second Lieut. Chester E. Weaver, of Berkeley, Calif.

The Southern Cross, with call letters KHAB, has been heard by several amateurs while it was flying over the Pacific on its way to Australia. A characteristic of the signal was the steady dash while the key was held down. (Power obtained from wind-driven generator).

The Railroad Radio Operators' League is an organization of Morse railroad telegraphers who are interested in amateur radio. We are told that most of the members of the R. R. O. L. belong to the A. R. R. L. also, and that most of them own and operate their own short wave sets. Welcome, OM's!! The Chief Traffic Manager of the R. R. O. L. is M. G. Barrick, 8AKQ, Moatsville, W. Va.

RE ELECTIONS

A.R.R.L. Members in the following Sections did not file valid petitions nominating a Section Communications Manager for the next two-year term of office before May 28, the closing date announced for receipt of such nominating petitions. In some cases the petitions were declared invalid because received after the legally announced closing date, or because they contained less than five signatures of A.R.R.L. Members in good standing.

Western New York Section, Atlantic Division
 Indiana Section, Central Division
 Ohio section, Central Division
 North Dakota Section, Dakota Division
 Mississippi Section, Delta Division
 Kansas Section, Midwest Division
 Maine Section, New England Division
 Vermont Section, New England Division
 Alabama Section, Southeastern Division
 Oklahoma Section, West Gulf Division
 Southern Texas Section, West Gulf Division
 Utah-Wyoming Section, Rocky Mountain Division

Due to resignations in the North Dakota Section, the Iowa Section, and the Arkansas Section, the following officials have received appointment as Acting Section Manager until A.R.R.L. Members have duly nominated and elected Section officials:

Prof H. L. Sheets, 9DM, Brinsmade, North Dakota.
 H. W. Kerr, 9DZW, Little Souix, Iowa.
 H. E. Velte, 5ABI, 5408 U. St., Little Rock, Ark.

In these three Sections nominating petitions are hereby solicited for the office of Section Communications Manager and the closing date for receipt of nominations is herewith specified as noon, July 28, 1928.

In the Western Pennsylvania Section of the Atlantic Division, G. L. Crossley, 8XE, the present incumbent, and A. W. McAuly, 8CEO, 309 Third St., Oakmont, Pa., were nominated. Election results: McAuly, 64; Crossley, 39. Mr. McAuly is herewith declared elected. He assumes office at once.

Members in these Sections are herewith informed that the closing dates for receipt of nominating petitions at A.R.R.L. Headquarters is set ahead to noon of July 28, 1928. The closing date for receipt of nominating petitions from other Sections in which the Section Manager's term of office expires within the present year remains as indicated in the notice appearing on page 50 of May 1928 *QST*.

Members are urged to take initiative at once, filing petitions for the officials of each Section as may be necessary. It is suggested that the form of nomination printed on page 50 of May 1928 *QST* be followed closely.

—F. E. Handy, Communications Manager.

DIVISIONAL REPORTS

ATLANTIC DIVISION

MD-Del. D. of C.—SCM, H. H. Layton, 3AIS—1AM very sorry, fellows, that no report appeared in *QST* last month but was very QRW rebuilding station. 3AIS is now C. C. on 38.25 meters. Delaware: 3AED is moving to Chester, Pa., so will be off the air until Fall. 3ALQ is going strong in Felton. 3WJ punctured his crystal but is back on the air again. There are a few non-ORS in Del. Let's make the state 100% fellows. Maryland: The SCM had the pleasure of visiting 3APX at Annapolis last month and found Midshipmen Ferrier, Jones and Stretch to be real hams. 3AEI is on 80 meters every night but Friday. 3BBW is very active at Baltimore on 40 meters. 3CGC is going to work for Atwater Kent at Phila. for summer so will be off the air until Fall. The SCM would appreciate more reports from the Maryland gang. Dist. of Columbia: 3ALF manages to handle some traffic when not QRW school and is going to rebuild xmitter soon. 3GT at Bolling Field is the Dist's best traffic station.

Traffic: Del. 3AIS 2; Md. 3APX 4, 3AEI 12, 3BBW 5; D. of C. 3ALF 9, 3GT 42.

SOUTHERN NEW JERSEY—SCM, M. J. Lotysh, 3CFG—Nine ORS were cancelled this month, who have not reported during the last six months. They were fully warned by letter and last *QST*, so there should be no regrets. 3BSD leads us this month with a nice total. 3CFG fell down due to other activities. 3IV has a good total. 3SJ came thru in good style. 3BWJ took WNP's report to HQ. FB. 3AC is now on 20 meters. 3UK has a new Ford now. 3AIU is handicapped with low power. 3ZI and 3CFG handled emergency PRR traffic. 3KJ and 3SK complain of no traffic 3ARC turned in a nice total. 3UT reported with a nice letter. 3AOC, 3AOM and 3DH will be off until school reopens in the fall. 3BEI is rebuilding and promises activity. Many non-ORS turned in nice totals. We need more ORS so send in your applications and please report on the 26th.

Traffic: 3CFG 59, 3IV 33, 3SJ 24, 3BWJ 12, 3UK 11, 3AC 11, 3ZI 7, 3KJ 2, 3BSD 12, 3AIU 9, 3ARC 24, 3AOC 4, 3DH 12.

EASTERN PENNSYLVANIA—SCM, J. B. Morgan, 3QP—3ZF, 8WJ and 3AKB all have new rigs working nicely. 3AFJ, is moving traffic from his summer station, 3AUI. 3LC, 8CWO, 3AKB and 8DHT are keeping traffic moving. 8KQ and 8AVK are still in the throes of rebuilding. 3ADQ complains of financial and YL QRM. 8AVL is DXing on 40. 8QM has QSK'd all schedules for a time to become associated with the Electrical Research Prod. Corp. FB. 3CDS complains that most of the gang don't want to QSR any more. What's the trouble, gang? 3ADE has a new job now and is learning the Morse code so he can't operate the set much. 3ZF is on with full power and getting out thru QRW.

Traffic: 8WJ 49, 3AFJ 40, 3LC 31, 3RQ 1, 3QP 194, 8AVK 14, 3AKB 225, 8HH 26, 8ADQ 80, 8AVL 14, 8CWO 85, 8DHT 268, 3QM 43, 3CDS 1, 3ADE 51, 3ZF 78.

WESTERN NEW YORK—SCM, C. S. Taylor, 8PJ—8ADE worked Australia and New Zealand. 8AFG was laid up for ten days but handled many messages locally. 8AHC made the BPL and had several schedules. 8AIL has just returned from Europe and will be on with an 852 soon. 8AKZ worked xel-OIP in the Atlantic Ocean off Mobile, Ala. 8ANX has moved to Gloversville and will build a new station. 8ARX is using a Zepp antenna with good results. 8AVS handled lots of traffic with oh-6DEY and eg-6CL. 8AWG, an old timer, is returning to the game. 8AYB is still at it handling traffic and arranging schedules. 8BFG has been keeping schedules with several locals clearing up much traffic. 8BLP has been off the air but will soon be with us again on a 7½ watter. 8BMJ has been bumming around the country lately. 8BQK has been working at G. E. so transmitter has not been active. 8CDE worked Sweden and handled traffic at an Exposition. 8CDC now operates the set with 8 eliminators on the plate. 8CNH handled traffic with nr-2AGS. 8CNTT states traffic is slight on 20 and 40 meters. 8CNX will be off the air due to empty socket. 8CDH is a new station at Lockport owned by the Lockport Light, Heat and Power Co. 8CSW has been keeping many schedules and handling traffic. 8CVJ has abandoned schedules for the summer due to a new YL. 8DII worked nz-FO5 for two hours steadily. 8DME is in the Army Amateur Net and has many schedules. 8DQP handled a message for Austria, and 8DSP handled one for Honolulu. 8PI has been sick so could not report this month. 8QB has been off the air due to the death of his mother but is now back with us again. 8BAG, 8CPC and 8UL have all gone to Europe and will have lots to tell us when they return. The SCM would like every station in the Section to send him their station cards as he needs them for checking purposes.

Traffic: 8ADE 20, 8AFG 220, 8AHC 136, 8ARX 88, 8AVS 10, 8AYB 116, 8BFG 6, 8BMJ 34, 8BQK 1, 8CDB 123, 8CDC 20, 8CNH 1, 8CNT 10, 8CNX 47, 8COH 6, 8CSW 87, 8CVJ 34, 8DII 78, 8DME 32, 8DQP 9, 8DSP 69, 8QB 5.

WESTERN PENNSYLVANIA—SCM, G. L. Crossley, 8XE—Few stations reported this month and all have a low message total as compared with other months. 8CFR and 8CFY report inactivity this month due to work. 8ABW was off due to power leak and poor receiving conditions. 8ARC reports that he handled all traffic on 20 meters. 8BGW reports activity on 40 and 80. 8VE is having his exams at medical school. 8CNZ worked OZ with his 210 but he is now using an 852. 8BRM is still on 20 meters. 8DKQ a new amateur at Huntington is working on 40 meters. 8GI has been setting a hard pace with midnight oil and has let down a little because of advice of the doctor. 8XE is still busy on Convention work. 8CEO is rebuilding his transmitter for remote control operation without interruption of schedules. 8CES is working on the 80 meter band and doing some fine work. 8AKI is working both 40 and 80. 8CUG is working on 20 meters and handled

some traffic. 8CKN is a new operator in Erie. 8CAE is on the air again using a 210. 8LS is using an 852. 8BVG is boating on Lake Erie and too busy for radio. 8BHN is QRW in the garden. The SCM wishes to express his highest respect to the gang in this Section and in the other Section that took part in the Emergency that existed during the snow storm that hit Western Penna. the weekend of April 28. 8CYP uses a mercury arc now and it works FB. This Section may have a new SCM after this month because of the results of the election. The present SCM thanks all ORS and League members for their support in the last two years and hopes that the same undivided support will be given the new SCM.

Traffic: 8CFR 141, 8XE 122, 8DOQ 84, 8DRQ 82, 8CEO 51, 8CUG 48, 8AKI 44, 8GI 32, 8BRM 26, 8BGW 23, 8ABM 19, 8CES 10, 8CNZ 10, 8CAE 6, 8ARC 5, 8DFY 3, 8VE 2, 8CYP 24.

CENTRAL DIVISION

MICHIGAN—SCM, Dallas Wise, 8CEP—SCU now uses d.c. on his 210's and says he likes it much better than the a.c. 9ANT's schedule with 9CE boosted his traffic total some. 9CE reported by radio to 9CSI. 9CED is back on the air again on 20 and 10 and promises to report regularly from now on. 8CWK is silent due to heavy QRM from work. 8ZF has only one op now due to the new ruling of the Radio Commission. 8BWR has been going great and now has the transmitter working on both 80 and 40. 8DVQ is a new comer at Holland, Mich. Welcome to the gang, OM. 8KN is moving to Eastern High School, Lansing and will be on the air again in Sept. from there. 8BRS reports trouble with the weather and the loss of his schedules. 9CM says little traffic up his way. 8CKZ has the set going at the new QRA and steps out good. 8AAF is having trouble with the BCLs. 8BAX, a newcomer in Lansing, turns in a good total for his first report. 8DFB blew a borrowed 50. Hi. 8AUB has been listening on 10 meters but says ND as yet. 8DCD of Battle Creek is active again but doesn't say in what band. 8ACU operates now and then but handled no traffic. 8CNK is trying to get some state schedules working on 40. 8DEX is busy playing baseball but was on for the QSO party. 8DSF reports he will be silent until Oct. first. 8ZZ has been using 500-cycle plate supply since he blew his MG. 8COW, 8ZZ and 2CEP attended the First Central Division Convention at Milwaukee, and now have some first hand information on portable receivers, etc.

Traffic: 8DKX 70, 9CE 51, 9ANT 47, 8CED 9, 8BWR 108, 8DVQ 19, 8BRS 14, 9CM 3, 8AAF 4, 8BAX 46, 8DFB 25, 8AUB 40, 8DCD 19, 8CNK 17, 8CEX 22, 8DED 105, 8SC 19, 8CEP 33.

KENTUCKY—SCM, D. A. Downard, 9ARU—9BCL is handling service for a radio shop in Sioux City, Iowa. 9HL is home from sea. 9BWS gets R5 and 6 reports from OA and OZ stations. 9CJW is graduating from Centre and will soon be 9BGU in Caruthersville, Mo. 9CRD has a WAC tag. 9EKM says 20 meters is the berries. 9RGA has a 210 on 20 and is working everything he hears. 9MN put up another new stick. 9BAZ only had to work Asia to get his WAC slip and someone heard one calling him and he didn't. Hi. 9ENR says the gang in Covington and Cincinnati attended the Southwestern Ohio Hamfest at Dayton, Ohio, and a fine time was had by all. 9AID reports his station not working because of sickness in family. 9BAN seems to be handling a lot of traffic for the Philippines, China and Hawaii. 9DLU is off until winter. 9DDH has a Zepp antenna for 80 meters.

Traffic: 9ATV 44, 9BAN 41, 9BJW 30, 9CRD 22, 9EKM 15, 9BGA 14, 9MN 10, 9BAZ 9, 9ENR 8, 9ARU 5.

OHIO—SCM, H. C. Storck, 8BYN—Summer is here, and QRN has been getting in some awful wallops. It's a temptation to get outdoors and forget radio for a while but don't let the bottom drop out of things. Only two made the BPL this month, 8AVB and 8DDF. 8AVB got his on 40 while 8DDF used 80. 8CQU comes third which is good but as usual, he has nothing to say about himself. 8BBER is bothered with X-ray QRM. 8CNO says nothing like early morning schedules for QRN less QSOS. 8CAU, at the U. of Cincinnati, has been demonstrating two way radio-phone to the public. 8CFT reports working some good DX. 8BOR and 8BAU are working on television. 8DDK still has BCL QRM. 8DSY made WAC by working op-1GZ. 8AZO got 32 on 40 meters without schedules. 8AMI is looking for more power and hoping hard. 8EQ is working on 40. 8DBM is swearing off DX and going back to traffic. FB. 8CMB

reports no news. 8GZ has been working with 10 meters. 8CCS has power leak trouble. 8CNC stages a battle royal, 8CNC vs. BCLs, with the RI in his corner. 8BAC is going down on 20 for the summer. 8CNU has been picking up some extra "jack" via the Morse code route. 8BKM's MG is too much for his 210 and he blew his 50 so he is going to sell the MG and use the money otherwise. 8DMX also has an MG for sale. 8DNL has been working EP and OZ with a 210. 8CFL reports baseball QRM still. Hi. 8DJV been QRW with exams and YLs. 8RN turned commercial op again. 8DJG worked a ship off the coast of Summit Lake, which is 5 blocks from his station. Hi. 8BBH says the weather has been too bad to work much. 8BKQ is working on 20 meters entirely. 8OQ didn't do much this time as he was helping 8CTD blow up his 50 watter. 8PL is using a 210 C.C. set. 8DQZ has been QRW graduating from OSU. 8DHS is going to try 10 meters. 8DIA is going to 20 meters for the summer. 8CCG is very QRW and not on much. 8BOP says he can't find enough traffic on 20 to keep him awake. 8ARW will be on within a month with a new set. 8AYO has been rebuilding. 8SI has been off the air but is coming back again. There will be a lot of rebuilding this summer with the new regulations coming on and all, and that will be just too bad for traffic also, but the few who will stick will get their share. The Ohio State Convention will be held in Columbus Aug. 17, 18 and 19.

Traffic: 8AVB 226, 8DDF 226, 8CQU 117, 8BRR 106, 8CNO 84, 8BYN 76, 8CAU 73, 8CFT 54, 8BOR 40, 8DDK 37, 8DSY 32, 8AZO 32, 8AMI 31, 8EQ 31, 8DRM 30, 8CMB 25, 8GZ 25, 8CCS 22, 8AWN 20, 8CNC 19, 8BAC 19, 8CNU 15, 8BKM 9, 8DNL 8, 8CFL 7, 8DJV 7, 8RN 7, 8DMX 5, 8DJG 4, 8BBH 3, 8BKQ 2, 8OQ 2, 8PL 1, 8DQZ 1.

INDIANA—SCM, D. J. Angus, 9CYQ—9AIN again leads the state for traffic handled. 9EZ is a close second and both 9EZ and 9FGD made the BPL. 9EZ will be off part of June as there is an intermission in school activities during that time. 9AYO is putting in an 852 tube. 9EKW is trying his hand at grinding crystals. 9BKJ and 9CLO are going to try crystal on 40. 9CVX cracked his crystal trying for the last inch of DX. 9EGE is trying 10 meters. 9FGD is leaving Valpo telegraph school and returning to his 9ARE at Owen, Wis. 9EYI is a new station in Richmond. 9EVA is off for a short time due to transformer trouble but will be on again soon. 9FLU has decided to move to Kalamazoo, Mich. 9ASX and 9EVA have joined the Naval Reserve. 9BKJ reports that the Fort Wayne Radio Club is growing rapidly due to increased local interest in amateur radio. 9FJT is a new one at Fort Wayne. 9DPJ is going to start up again on low power. 9BWI has got his BCL QRM conquered so is at it again on fone. 9AMZ has given up fone for 40 meter code. 9ELL has a fine new antenna but now needs a set to hitch on the end.

Traffic: 9AIN 509, 9EZ 476, 9DBA 85, 9AYO 55, 9ABW 45, 9BZZ 41, 9AEB 4, 9BKJ 27, 9CVX 19, 9EGE 8, 9EYI 60, 9EKW 70, 9FGD 157, 9CRV 51, 9EVA 9, 9ASX 71.

ILLINOIS—SCM, W. E. Schweitzer, 9AAW—Fred Hinds, 9AFY has been elected the new SCM for Illinois for the term ending June 1930. In the future, please send all of your monthly reports to him. I know Fred will be able to carry on your activities even better than I have been able to do, and I know that you will give him all the cooperation in the world. 9AAW has been equipped with rectohub rectifiers and is now on the air with DC. 9AAS in his first report mentions working nj-2FA receiving an RS report on his sigs. 9ACU has rebuilt and is working on 41 and 21 meters. 9AD is working on a crystal transmitter and says the planting of 75 acres of corn kept his traffic report small. 9AFA is still busy with WNP traffic most of which is coming through the central states. 9AFB will be on again after June 15. 9AFF hopes to have his television transmitter going soon. 9AFX is taking a trip to Montana. 9AGG says traffic took a slump because of the YLs. 9AHL hasn't been on lately. 9AHK says everything out his way is rosie. 9ALK is busy with work. 9AMO reports summer weather hard on schedules. 9ANQ is going to stick to traffic unless ten meters gets too alluring. 9APY is arranging schedules with route managers and ORS for transcontinental work. Mr. and Mrs. 9AQA report the arrival of a new baby girl. 9ASE had to QSK schedules because he is working nights. 9AWX was on only a few times during the last month. 9BHT is on a fishing trip in northern Minnesota, with a

portable. 9BNI is on a vacation and will come back on the air with crystal control. 9BRX hopes to be on more regularly when school lets out. 9BSH was off with the flu and still feels kind of wobbly. 9BTX would like to find someone to play chess by radio. 9BZO also reports a scarcity of traffic. 9CAR is going to put in crystal control this summer if the resources of his pocketbook will permit it. 9CCZ is busy playing baseball and only pounds brass when he receives QST. 9CIA had 84 foreign QSO's during the last month. 9CKM has a new plate transformer and rectifier. 9CMX is busy with radio at Crane High School of Chicago. 9CNB blew his H tube and is now using a 210. 9CNY is on 160 meters with phone. 9CUH and 9UUV are the only two active stations in Waukegan at the present time. 9CUO has listened on 10 meters but results are nil as yet. 9CZL is going to put DC on his 381's. 9CZT is going to take his portable along on his vacation trip. 9DCK received a report from fm-8SF. 9DGA worked 4 continents with his 210 tube. 9DOX reports 9CNH back on the air. 9DSO has some antenna trouble, and thinks he will go back to the voltage feed Hertz. 9DSU has best results with his antenna and counterpoise. 9ECR can't be on much because of BCL QRM. 9EGX sent in his report via 9FGD. 9EGX is going to start experimenting with phone. 9EJO is working better and better DX. 9EPG cleaned up his rectifier and now is getting pure DC reports. 9ERH wants to put a portable radio on their yacht. 9EYA finds very little traffic on the 40 meter band. 9FCU in Lawrenceville is going strong. 9FDJ is on between 11 am and 11 pm daily. 9FO is lining up a high speed break-in schedule with 8ADA. 9IZ lost a couple of his aerials when the roofers removed them while tarring the roof. He says that 9FPF is located only 50 feet away. 9KA hopes to get back on soon. 9KB QSR his traffic via Uncle Sam. 9QD reports no results with his television outfit as yet. 9PU will be on regularly again during the summer.

Traffic: 9BZO 138, 9CIA 136, 9AFA 93, 9FO 90, 9AMO 77, 9CZL 60, 9BNI 54, 9ASE 53, 9AHK 51, 9AAS 47, 9CNB 50, 9AD 41, 9APY 41, 9BTX 34, 9EJO 26, 9CAR 26, 9DCK 22, 9DOX 21, 9QD 19, 9CUO 17, 9DSU 16, 9CUH 15, 9FCU 14, 9EPG 14, 9CZT 12, 9KB 11, 9DSO 10, 9ERH 8, 9BSH 8, 9ACU 8, 9CNY 8, 9DBI 7, 9EGX 7, 9AGG 7, 9ALK 6, 9IZ 5, 9EGX 5, 9FDJ 4, 9ZA 4, 9DGA 4, 9MI-PU 3, 9CKM 3, 9ECR 6, 9ANQ 2, 9BVP 1.

WISCONSIN—SCM, C. N. Crapo, 9VD—9DLD, our RM, still leads the state and promises that he will be in the BPL all summer. 9DLQ is second this month but will be off the air until September. 9DTK had to cancel some of his schedules because of skip distance effect but expects to continue with them later. 9DNB worked OZ and handled his share of traffic this month. 9EEF had schedules with 9DLQ and 9EQP on 40. 9DND still keeps two schedules but complains of signal intensity decreasing. 9SO keeps six schedules and works a five point system. 9ABM has trouble with schedules during poor radio weather. 9EWY has been off the air getting his new set going. 9BPW attended the Convention and took an exam. for commercial ticket. 9BWO tried out a new antenna but says the old Hertz is hard to beat. 9BJY was not on the air consistently this month due to an operation. 9LV has installed CX381 rectifier tubes for his UX210. 9DEK has a schedule with 9CKM daily on 82. 9AZN is slowing down in handling traffic due to other activities. 9BWZ has been sick a great deal this month. 9EBT was sick and unable to attend the Convention. 9DJK is down on 20 and says he has forgotten traffic until fall. 9FAW is a new station at Stanley with RAC on 210. 9CVI has his MO-PA set going now and will probably stir things up in So. Milwaukee this month. 9EWN says if there wasn't so much static these nights, he would sit in and handle a few messages.

Traffic: 9DL 205, 9DLQ 181, 9DTK 128, 9DNB 83, 9EEF 80, 9DND 78, 9SO 56, 9ABM 46, 9EWY 34, 9BPW 27, 9BWO 26, 9BJY 15, 9LV 11, 9DEK 10, 9AZN 9, 9EBT 6, 9DJK 6, 9FAW 4, 9BWZ 9, 9EWN 2, 9CVI 1.

DAKOTA DIVISION

SOUTHERN MINNESOTA—SCM, D. F. Cottam. 9BYA—A decrease in traffic is noted this month but the fine weather, fishing season, etc., are very good reasons for giving the junk a rest for a

while. The SCM is going to put on a little contest and the station in this Section having the highest total of traffic for June, July and Aug. 1928 will receive one UX210 and the next highest will receive one 222 shield grid tube. Your logs of these three months to be sent to the SCM after the August report has been sent in. These prizes are not big ones but I hope they will spur the brass pounding some. We are also interested in receiving the logs of the messages because from them we may be able to make various helpful suggestions. 9COS makes the BPL for the third consecutive month. 9XI keeps one schedule. 9AIR is leaving on a 1500 mile tour. If you hear 9FGK, his portable which he has with him, give him a buzz. 9DOP reports two new stations 9FJI and 9FPY. 9BTW handled a rush message (doctor's certificate) for WUAQ. 9EFO keeps one schedule. 9ELA handled one rush message and he reports a new station, 9FNC. 9BYA has been on 20 and 40 with a new vertical ant. of copper tuning. 9BKX reports as usual. 9EFK has been off the air on account of heavy work but is on week-ends at times. 9BFO says the attic has been too hot for much pounding but is installing some new fans to keep himself and the set below the melting point. 9DHP keeps one sked on 20 and was QSO 9A-3GR. 9ERT will be exhibited at the National Educational Assn. Convention in July. 9DBW keeps one schedule and otherwise is off the air because he is very QRW. 9EYL is on 20 because he says it is best. He is doing some very nice work with a 210. 9DGE is still on the barge line and says he misses the old ham set. 9DEQ is very busy and is off the air for a while. 9DBC is home from the A.T. and T. school and will be on four bands in a very few days.

Traffic: 9COS 249, 9XI 43, 9AIR 32, 9DOP 29, 9BTW 24, 9EFO 15, 9ELA 14, 9BYA 14, 9BKX 11, 9EFK 9, 9BFO 7, 9DHP 5, 9DBW 4, 9EYL 3, 9DGE 1.

NORTHERN MINNESOTA—SCM, C. L. Barker, 9EGU—The summer slump seems to have taken a hold all right judging by the small number of reports received this month. 9EIX is moving to Wheaton to take up duties as telephone lineman. 9EHO says he is open for schedules daily and reports QRN fierce on 80 meters now. 9EGU is off the air just temporarily while finishing some work on his new summer cottage. 9AIR recently paid 9ABV a visit. 9CIY is moving his business so will be off for a while but will soon be on with a new Belgian IKW tube. 9BMX says 20 meters has slumped badly. 9AKM hasn't been on at all the past month. 9DPB rebuilt his Zeppelin antenna and hooked oh-6ALM first crack. 9EGF can't raise a thing with his new Hertz antenna. 9BCT reports that one power transformer crossed the "River Styx" and now is "Among (his) Souvenirs". 9AOK worked his 46th country by spearing as-35RA. 9EGN will soon be on regularly since the U. is soon out. 9BIW has been "firting" with 10 meters. 9EHI worked WNP on 20 one afternoon.

Traffic: 9EIX 82, 9EHO 58, 9DPB 26, 9EGF 20, 9CIY 17, 9BCT 17, 9AOK 10, 9EGN 6, 9BIW 2, 9EHI 1.

NORTH DAKOTA—Acting SCM, Prof. H. L. Sheets, 9DM—9DIC has changed from a selfrectified layout to a chemical rectifier and has quite a kick. 9IK reports two new stations down in that neck of the woods. 9FMC Havana, and 9FLF, Cogswell. It seems as though there were more coming to light all the time. 9DYX reports no traffic but was heard in England. 9BRR reports QRN heavy on 80 meters. 9DYA is still trying to work low-power fone DX. 9DM has been QRW with school work. 9BVF is too busy graduating this month to report.

Traffic: 9BRR 6, 9DM 4.

SOUTH DAKOTA—SCM, F. J. Beck, 9DB—9DNS turned in a FB traffic report and reports two new stations in Sioux Falls, 9FQH and 9FQX. 9ESD is moving to Platte where he will operate with 9AZR. 9BKB has been QRW exams. 9EUH QSY'd to 20 meters but has a power leak. 9DGR handled a rush message from na-7MN to a Duluth hospital. 9DLY is in the hospital in Huron. 9AGL has the CC transmitter going FB. He is preparing to work on the television reception this summer. 9FOQ is a new station in Milbank using a 210. 9NM is planning on storage Bs for plate supply. 9BOT had an operation but is recovering FB. 9DB is rebuilding and on vacation. 9AJP is having trouble with his rectifier.

Traffic: 9DNS 32, 9EUH 22, 9DB 21, 9DGR 11, 9ESD 5, 9AGL 4, 9BKP 1, 9AJP 3.

DELTA DIVISION

TENNESSEE—SCM, L. K. Rush, 4KM—Reports from this Section have been very scarce of late. No reports are being had from some ORS. 4SP is training his two brothers the way of the ham and they are all set for a license. The Knoxville Radio Club staged a DX contest and are all wondering who is the winner. 4ABZ says that he has been blowing filter condensers, building new receivers, etc. 4ARR says he may get to Calif. and wants the gang to look for him. 4KM has moved and the status of the station is in doubt as the transformer in the block is not large enough to pull the three HP motor on the MG.

Traffic: 4ABZ 31, 4SP 10, 4ARR 6.

LOUISIANA—SCM, C. A. Freitag, 5UK—5NE has been experimenting with 5 meters. 5KH and 5ANC are hot after traffic and say they are doing their share to put Delta Division back on the map. 5LV has kept schedule with 5EB for three weeks. 5EB's sister-in-law was in the hospital and 5LV gave her the daily dope via radio. Good work, OM. 5IE says he finds 20 meters very changeable. 5ANC kept schedule for three days with ER-3 when 70 airplanes passed through on way from Montgomery, Ala. 5PM reports that he is turning in his ORS for cancellation, as he is going to school in England for a year and then off to college. 5RD says he has not been able to establish many QSOs. 5QJ is still working on 20, 40 and 160 meters and is able to find some time for 10 meter experiments. 5HR is on the air regularly each night. Half of 5HR's messages (he had 86 del'd) were arranging "dates" between 5AAY and several young ladies in New Orleans. Ask 5AAY for dope. 5EM has at last been successful in clearing up his modulation. 5QO is gradually being straightened out on phone and will be working OK within a very short time.

Traffic: 5KH 41, 5LV 38, 5IE 13, 5ANC 12, 5RD 2, 5UK 15, 5HR 150.

ARKANSAS—SCM, W. L. Clippard, Jr., 5AIP—Fellows, this is our last report together. I certainly have enjoyed my work with you as SCM and I want to thank you for the splendid cooperation you have shown. I only regret that I have not done more for you. 5ABI will be the acting SCM until the next election which will be held in the near future. In the meantime, please get in touch with him at 5408 U St., Little Rock, Ark. and give him your best of cooperation. It is sure discouraging to an SCM when you don't. 5ABI has been in the game since the war and has been very active all the time. We wish to extend our sympathies to 5CK whose father died this past month. 5ZAA was badly injured but we are hoping that he will be well soon. 5AQX has also been sick but is up again and well.

Traffic: 5ABI 24, 5EP 18, 5SS 13, 5AQX 4.

MISSISSIPPI—SCM, J. W. Gullett, 5AKP—5AFD just finished a three weeks' fishing trip so he only handled a few messages. 5AGS's station needs overhauling but guess nothing doing due to the high price of cash. He will have 5AGM on the air at the Boy Scout Camp during July and Aug. 5ANP reports the death of his Mother and doesn't know just when he will get going again. Sorry to hear of your mother's death, OM. 5FQ says he thinks it would be a good piece of work if the SCM would stop all QRN-QRM-QSS etc. then he might get some good DX to report. HI. 5API reports that he is still going strong with the only ham phone in Miss. 5AYB reports traffic scarce on 20 meters but says it is FB for all other purposes. 5AJJ commutes to New Orleans every day and hasn't much time to operate the set. 5AKP reports working SC, EG, OH and OA lately, on 20 meters.

Traffic: 5AKP 75, 5AGS 1, 5FQ 14, 5API 2, 5AYB 41, 5AJJ 8, 5AED 8.

HUDSON DIVISION

NEW YORK CITY & LONG ISLAND—Acting SCM, J. B. Kilpatrick, 2EV—Manhattan: 2BCB is doing good DX now on 20 and 40 meters. 2BDJ is off the air for a while. 2BNL is still plugging along. 2CHU sends in his first traffic report in two years. 2EV has dismantled his station and is going to Calif. 2KR is doing good work now. Bronx: 2AET is observing HCL quiet period now. 2ALP is QRW school. 2BAD is going strong at his new QRA. 2CYX says DX and traffic are FB now. Brooklyn: 2ADZ will be off the air during the summer. 2AJL was QRW at the Convention. 2BDM is rebuilding to a MO-PA now. 2PF was QRW convention and

school and will have crystal going on 10 meters soon, he hopes. Long Island: 2AYS claims to be QRW at present. 2GP is working FB on 10, 20, 40 and 80 meters now. 2TY wants an ORS and seems to have lots of traffic now.

Traffic: Manhattan: 2BCB 24, 2BNL 8, 2CHU 12, 2EV 10, 2KR 72, Bronx: 2AET 13, 2ALP 26, 2AWU 11, 2BAD 57, 2CYX 68. Brooklyn: 3ADZ 30, 2APD 10, 2AJL 6, 2BDM 12, 2CCD 25, 2PF 50, 2UI 39. Long Island: 2AYS 5, 2GP 39, 2TY 63.

EASTERN NEW YORK—SCM, F. M. Holbrook, 2CNS—Sixteen stations report 412 total messages. 2AXX and 2AUO handled traffic from enKY (Vienna) to Duke Schiller, relief aviator to Bremen Expedition. 2APQ says the asst. YL op has qualified so be QRV for her. 2CTH has a new Zeppelin. 2ANV has kept a schedule with 1AWQ for two years. 2ABY has to keep quiet hours for BCLs. 2BKE has rebuilt the transmitter and antenna. 2AYK is chief op at 2BGR, Fordham Uni. at Hudson Div. Convention, the SCM saw 2AGQ draw ticket for a free airplane ride to A.R.R.L. Headquarters. HI. 2ACY is our newest ORS and has schedule with 8DKY. Tupper Lake and will clear traffic from Adirondacks. 2ACD wants an ORS. 2QU is moving junk to a new QRA. 2ALI is now chief op of WOKO on top of Mt. Beacon, N. Y. and will soon have short wave transmitter working 1700 feet above sea level.

Traffic: 2AYK 70, 2QU 70, 2ACD 53, 2BOW 45, 2ABY 26, 2BKE 25, 2ACY 20, 2AXX 18, 2AGQ 15, 2ANV 16, 2CTH 14, 2AUO 12, 2CNS 23, 2APQ 5.

NORTHERN NEW JERSEY—SCM, A. G. Wester, 2WR—Despite warm weather over 500 messages were handled in our Section. 2JG continues to make things hum in Keyport on 80. 2WR maintained a few schedules with NIDK for Boston traffic. 2AT is the only station to make the BPL this month. Domestic duties are keeping 2CP, the RM, from holding the traffic lead in this Section. 2CW made 120 QSO's in May which is very FB. 2EY again has sickness in the family. 2JC is not on the air as yet with the new high power transmitter. 2ASZ is helping a beginner get started as an amateur. 2KA is fixing up the shack for fall work. 2BDF passed his commercial examination and is now an operator at WAAM. 2ANG also maintains a schedule with NIDK the Ice Patrol. 2MD will be heard on 20 with a big bottle shortly. 2CTQ sent his report in from Baltimore. 2CJX is playing with 10 meters and wishes more stations were there. 2BY has the good fortune of having 2AVK rebuild her transmitter which accounts for no traffic report from 2AVK. 2BR says Spring Fever has kept him off the air. 2IS handled some important European traffic. 2ADL fears that he will leave this Section for the south shortly. 2BAL took a message from ed-7JO for WNP. 2JX can not raise anybody with his new transmitter. 2AOP cannot find time to operate. 2AEB has had fine QSO with foreigners last month and worked 4 continents. 2BME sent in his first traffic report and applied for ORS.

Traffic: 2WR 6, 2AT 118, 2CP 96, 2CW 7, 2ASZ 11, 2KA 2, 2BDF 34, 2ANG 5, 2MD 20, 2CJX 12, 2BY 5, 2BR 6, 2IS 19, 2ADL 87, 2BAL 4, 2DX 4, 2AOP 33, 2AEB 7, 2BME 65.

MIDWEST DIVISION

IOWA—Acting SCM, H. W. Kerr, 9DZW—Enthusiasm of the convention at Ames in April seems to be propagating plans for greater activities in Iowa. Crystal control, five, ten and twenty meters are some of the projects being developed by various members of the gang. Louis Huber, ex9DOA, has gone to Hartford to be Asst. CM to Handy at HQ. This should give greater encouragement to Iowa amateurs and we have assurance that he will be in close touch thru IMK. Kruse, our ex-SCM, is shifting from Continental to Morse with R.R. op in view. The traffic slump is just natural, schools closing and QRW everywhere, but a luck thirteen reported. 9CS leads and better look at his laurels as 9EHN with that FB DC note is now heard throughout the Dist. in QRN and QRM. 9EJQ is listening to Tens. 9EDW on 40 both A.M. and P.M. wants schedules. Our RM, 9CZC is starting a new ham. 9PB says silent for summer. 9DPL is grateful for 15 QSO's from 250 calls.

Traffic: 9CS 133, 9EHN 108, 9BAT 73, 9EDW 65, 9DZW 38, 9EHR 23, 9CGY 25, 9CZC 10, 9EJQ 10, 9PB 10, 9EHW 9, 9BCA 5, 9DPL 1.

NEBRASKA—SCM, C. B. Diehl, 9BYG—The Official Observer and Asst. Observer turn in a very detailed report but sorry to see so many stations listed there. Very few of them are Nebraska stations, however. 9CJT is busy with his work now. 9ANZ put on some emergency work for the Postal and some newspaper during the recent sleet storms. 9AWS is swamped with work on the job and says can't be on much as would like. 9EEW got "sore" at his receiver because OA and OZ stations wouldn't come through RS so tore it up and is rebuilding. 9DPR is very QRW taking exams for Annapolis, his "Sax" and his YL. 9DVR is QRW with spring work and housecleaning. 9GJD is a new station at Burwell. 9DI anticipates lots of work and otherwise this coming summer. HI. 9BOQ says that QRN almost gets him on 150 and 80 meters. 9CHB sure walks out even on 175 meters but says QRN is heavy. 9CDB is QRW with his work at this time and too QRW pounding iron to pound the key. 9BRQ is QRW with his work in Post office. 9EBL is QRW with his power house work and rebuilding completely. 9AEZ turns in an excellent total this time and contemplates applying for ORS. 9BBS is rushed to death with his work and has to rest every minute that he is home. 9EUT still bangs away and his totals sure show it. 9BKG, newest ORS, says his new receiver is a "WOW". Glad of it. OM. 9EXG wants to trade his set for a motorcycle.

Traffic: 9ANZ 13, 9AWS 1, 9DPR 2, 9DVR 5, 9BOQ 10, 9CHB 22, 9AEZ 24, 9EUT 22.

MISSOURI—SCM, L. B. Lazure, 9RR—9BEQ, 9AAO and 9BEU led in traffic in St. Louis this month. 9BEQ and 9AOT are now enroute to the west coast for the summer. 9AAO is keeping several schedules and can use more western schedules. 9AIQ sends his first report, he is using an old 202 and working good DX. 9DLB was QRT with condenser trouble and plans revamping the works. 9BEU says traffic took a jump at his station. 9AAU-ZK paid another visit to Kansas City and says traffic conditions are FB at his station. The SCM would like to get monthly reports from all new stations, admission is free. OMS. 9DZN had fair luck this time but no great amount of traffic moving. 9BMU also collected a few messages after some rectifier trouble. 9DUD will be on more regularly since school is out. 9BHF applied for an ORS and OBS. 9BSE reports using CW and fone on 84 meters. 9EPX is a first-time reporter and is coming up on 80 meters. 9DAE visited the gang in K.C. 9CRM rebuilt the works and has much better QSB. 9AJW-ERM led the whole state for traffic, keeping 4 schedules. 9AJW returns to Joplin as school closes. 9ERM goes to Wellsville but does not expect to be operating. 9AJW won a \$25 prize in mathematics at school and visions an 852 with trimmings. 9AJW and 9ERM did not miss a day's activity in 5 months. FB. 9BQS reports QRM from school and job. 9BJA is keeping about 10 schedules on 20, 40 and 80. 9BFB kept schedules with 9ERY and 9FRG. 9LI was off temporarily due to blown B batteries. 9CDF handled a good total and kept up his usual schedule with 9ERR. FB, OM. 9ASV kept a few schedules though others did not keep their's so well. The Joplin gang are starting a ham club again. 9DKG continues his schedule with 9ENU and reports another new ham in Columbia, 9FNU. 9BOE seems QRT. 9CCQ is QRT, farm work QRM. Sorry, OM. 9DEJ was seen carting home a flock of new filter condensers. 9FIO did not get much traffic this month due to QRN. 9ENU had a good bit of traffic. 9RR also had a good total but DX ND on account of QRN. 9BSB is on again with a new Zepp and MOPA. 210 set in a 5 kw. frame. HI. 9BUL is reported back on the air. 9ACA is leaving for Denver shortly and will be greatly missed here. 9BUR has a trick layout scattered through two rooms and the attic, thanks to unusually kind hearted landlady. HI. 9DQN has been doing some experimenting and built a new receiver. 9LD and 9ENU had bad luck at 9FAU when a windstorm blew down the tower ex-9ECZ is running a ham store at 15th & McGee Sts. and invites the gang to QSO. 9ZD has been doing some more experimenting. 9KM visited the gang on the Missouri side recently. A new ham club is reported in process of organization. 9DQN received his ORS and is also an OBS. 9ENU withdrew his ORS application on account of leaving for school in the fall. ex-9DZO is a new arrival in K.C. The SCM expects shortly to receive his commission as ensign in the USNR and appointed as Section Commander of Missouri and Kansas. Inquiries from in-

terested amateurs solicited and full information will be sent.

Traffic: 9REQ 63, 9AAO 59, 9AIQ 4, 9BEU 40, 9EK 12, 9DZN 26, 9BMU 10, 9DUD 18, 9AJW-9ERM 160, 9CRM 74, 9BJA 15, 9CDF 38, 9ASV 6, 9DKG 39, 9FIO 4, 9ENU 41, 9BSB 10, 9BUR 1, 9DQN 6, 9RR 101.

NEW ENGLAND DIVISION

CONNECTICUT—Carlton, A. Weidenhammer, SCM—The usual summer slump has started and stations in the aggregate report very little traffic and much DX. 1AMC hopes to have a fifty going soon. 1AFB has been rebuilding. Boston has claimed 1BQH for a time and the YLs have claimed 1ASD. 1BGC and 1BWM have been stepping out on 20 meters. 1VB, in quest of that distinctive note, has installed crystal control. 1VE has tasted the 20-meter band and pronounces it the best yet. 1AMG was busy on 80 most of the month. 1BJK worked Australia. 1ATG will be inactive all summer due to pressure of Naval Reserve work. 1BLF has been off the air. 1ADW handled some traffic with Germany. 1CTI is sporting a new Chevie. 1BNS is getting ready for exams. 1PE had good luck in working DX but had trouble getting traffic. 1MK reached a new high traffic level and promises to surpass all records. FB. 1TD, charmed the New Haven populace with an amateur exhibit at the Better Homes Exposition in that city. 1IM kept schedules with ef-8ORM and 2VM. 1NE has a new outboard motor speed boat and keeps all the shore residents awake. HI. 1IV is busy choosing a good job from several possibilities. 1ZL is experimenting on 10 meters. 2AWU's first operator has written the SCM to say that his gang will have a summer station running at Branford, call 1BKI.

Traffic: 1AMC 9, 1AFB 35, 1BQH 25, 1ASD 52, 1BGC 11, 1VB 13, 1VE 76, 1AMG 78, 1BJK 33, 1ATG 4, 1BLF 6, 1ADW 25, 1BNS 29, 1MK 521, 1TD 149, 1BWM 3, 1CJX 29, 1IM 36, 1IV 4, 1NE 3, 1II 8, 1PE 21.

MAINE—SCM, Fred Best, 1BIG—1BIG is doing a bit of experimenting on 10 meters but to date has heard nothing and has had no reports on his signals. 1CDX turned in his usual fine total and has some fine schedules with 1AWQ and 1ANH. 1HB has at last got the two fifties going in a fine full wave outfit. Mr. and Mrs. 1AJC put over a nice total and are busy with elimination of BCL interference. 1ANH reports some fine work on the part of 1CDX on their regular schedule, when a sick message was handled expeditiously thru very bad QRM. FB. 1AQL works regular schedules with 1ANH and 1AWQ and reports that a big crowd will attend the Convention from Bangor. 1BAY turned in his report by Western Union. FB. 1AIT, one of our old reliables, reports a schedule with 1BED on 81 meters. 1RFZ handled three messages. HI. 1AQD, a real pioneer on the 10-meter band, reports this time. He has worked 5HF twice on 10 meters which is quite some record. 1AQD reports hearing 1BIG's 20-meter signals twice during the past month. 1GFO sent in a report after a long lay-off. 1ASJ has his new Zeppelin up and he says it is working bully on 20 and 40 meters. 1ACV turned in his best total to date. He has an ORS coming to him upon making application. 1CDX reports a new ham, 1BOK in Norway, Maine.

Traffic: 1BIG 105, 1CDX 78, 1HB 29, 1AJC 25, 1ANH 86, 1AQL 18, 1BAY 15, 1AIT 10, 1BFZ 3, 1AQD 2, 1ASJ 6, 1ACV 42.

RHODE ISLAND—SCM, D. B. Francher, 1BVR—Things are getting rather dull in this state. Fewer and fewer reports are received every month. Come on, gang, show some pep. 1BQD is only on to keep schedule with 1MK. 1AQP has been QRW opening a new business for himself. 1AAL's report was received too late last month. He is QRW studying. 1BVB is now using a voltage feed antenna with much better results. 1BAT has been QRW with the YLs. 1BLS is doing heavy studying for school exams. 1MO did some very fine DX during the month.

Traffic: 1BLS 51, 1BAT 45, 1BQD 35, 1AQP 14, 1BVR 14, 1AWE 9, 1MO 8, 1AAL 6.

NEW HAMPSHIRE—SCM, V. W. Hodge, 1ATJ—Not much new this month, gang, as several of the fellows failed to report. However, the interest shown by some of the ORS is shown by their reporting by Western Union and special delivery. HI. Everyone complained of poor radio conditions which probably accounts for some of the small reports. 1BFT is

at the top this time but reports school QRM. 1CKK is reported as trying fone. 1AEF is DXing on 20. 1AVJ has made the WAC. FB, OM. 1AFD says the foreigners are pounding thru R9 with his new shield grid receiver. 1IP reports Spring fever. (Probably YLitis). 1ASR handled a bunch and is keeping weekly schedule with N. Y. C.

Traffic: 1BFT 82, 1ASR 62, 1IP 47, 1ATJ 44, 1AVJ 10, 1AEF 8, 1AFD 2.

EASTERN MASSACHUSETTS—SCM, E. L. Battery, 1UE—Summer seems to have hit us extremely hard. Traffic figures are very low this month. 1MX, non-ORS, is the only station to make the BPL while only 12 ORS reported. 1KY sent a fine letter to the ORS which should help put us on our feet next month. Those of you who are going away for the summer should notify the SCM so he may put you on the inactive list. 1BMS has gone to Europe on the U. S. S. *Nantucket* and won't be back until Fall. 1AKS still pounds at WCC and sends in good reports. 1AAW has dropped his schedules for the summer. 1NQ is doing nice DX. 1BVL was on 10 meters during the tests and worked a few "1's". 1ASI is building the transmitter for use with Byrd Expedition. 1ADM sticks to 20. Traffic and 1LM just don't connect. A recent birthday made 1AHV a man (?)—Dick is now 21. FB, OM. 1WV and 1KH keep up their DX. 1APK is experimenting with television. 1ALP is getting out fairly well on 20. 1BKV and 1ABA both have new cars. 1NK took a two weeks' cruise on an Eagle Boat in the U.S.N.R. 1BDV will be located at York Beach during the summer. 1UE is another 20 meter bug who likes DX as well as traffic. 1RL has a new Whippet which he calls Fannie. Hi. Starting Tues. July 3rd, the SCM will start a series of weekly broadcasts to ORS of Eastern Mass. Send in anything you have, which might benefit other ORS and make this *your broadcast*. These will be on approximately 80 meters at 7 pm EDT. Follow these broadcasts every week, if possible, as something of especial interest might be contained therein.

Traffic: 1MX 201, 1KY 37, 1WV 51, 1AHV 85, 1KH 27, 1LM 25, 1BVL 18, 1UE 13, 1ASI 12, 1ADM 16, 1AAW 4, 1ABA 4, 1NQ 3, 1APK 1.

WESTERN MASSACHUSETTS—SCM, A. H. Carr, 1DB—As Dr. John A. Tessmer 1UM, has been unanimously elected to be your next SCM and this may be my last report. I wish to say that it has been a great pleasure to have been your SCM for the past two years and I wish to thank the gang for the earnest cooperation which they have given me. Please do as well and even better for "Doc" for there is no one in this section more deserving of your support. He has been a good ham and a staunch friend of the radio amateur. He has our promise of cooperation and best wishes for success. I expect to be able to keep my ORS and be on the air and chat with you fellows now and then. If I can be of service to any of you, do not hesitate to let me know. 1AJK says he has been operating for the USNR once a week as usual. 1AKZ handled a death message from Denmark to Chicago. 1AMZ says he will be on the air regularly soon. 1APL has cancelled all his schedules for the summer and says the QRM from his motorcycle is bad. 1AQF has moved to 17 Mansfield St. and is going fine. 1RIV is an old married man now but is on every night from 7 to 8:30. 1BVR has worked a bunch of foreigners. The Springfield Radio Assn. made an official visit to 1MK and had a very fine reception there. They are on 80 meters and are operating Mon. Wed. & Fri. nights. They now have 21 members of which 9 are operating.

Traffic: 1AJK 5, 1AKZ 5, 1AMZ 1, 1APL 18, 1AQF 7, 1BIV 4, 1BVR 6, 1BWW 20.

NORTHWESTERN DIVISION

OREGON—SCM, R. H. Wright, 7PP—7YK held their annual exposition in which the student amateurs gave a splendid display of ham equipment. 7AEJ has gone to Alaska to operate a cannery station but will also run his own station there. 7FU has not been on 40 as regularly as usual but says he has good luck on 20 meters. 7AEK has erected a new antenna pole. Good weather and work keeps 7GQ's total down. Although 7UN says that power leak QRM is loud enough to dance by, he manages to get good reports from OHL, OA, and NA. 7AIX is moving but will be on in Astoria instead of Cor-

vallis until permanently located. 7ABH has worked NQ, AE and EF on 40 meters. 7MV has worked EG, OZ and AJ with his 210 besides holding a three-day schedule with KDSX, SS West Faraon. 7VQ and 7AEC are on consistently handling considerable traffic. 7AKK will act as temporary Route Manager for Oregon during 7AEC's absence this summer. 7ALK has worked NIDK, SS Mojave, over a thousand miles N.E. of Boston.

Traffic: 7YK 581, 7AEC 137, 7PP 120, 7UN 102, 7MV 84, 7VQ 61, 7AEC 29, 7ABH 24, 7ALK 11, 7FU 8, 7GQ 4, 7AIX 3.

MONTANA—SCM, O. W. Viers, 7AAT—Again 7HP takes traffic honors of the Section. 7HT is still right behind him, too. 7AAW handled a few and kept schedules with 9DFY on 20. 7FL says he is off the air for the summer vacation and will do some "X" work with 7ZU at the M.S.C. 7ZU built and tested a 40 and 80 meter transmitter. 7AAT lost a few antennas and was off most of the month.

Traffic: 7HP 109, 7HT 40, 7AAW 8, 7FL 4.

WASHINGTON—SCM, Otto Johnson, 7FD—A noticeable slump has taken place with the advent of summer weather. A great portion of the traffic handled was with Alaskan stations. na7ABE and na7HL send their reports through via 7TX. 7ABE's 91 messages represent 4164 words which mean some real messages. 7LZ, 7TX and a few others handle most of the northern traffic. 7FD is the proud father of a nine and a half pound son. 7AG is working OA with antenna in the basement of his house. 7TX, 7LZ, 7KO, 7AEV, 7ACB and a few others help keep Seattle on the air. 7BM from Aberdeen reports little traffic being handled in the Grays Harbor district. 7AKU keeps Bellingham on the map. 7VL reports much activity in Spokane, with many new hams coming on. FB, 7IZ and 7QG are on at Walla Walla. 7ACA was off temporarily. The Seattle gang are busy preparing for the Convention to be held Aug. 31 to Sept. 1. A large program is being worked out. Stations in Southwestern and Eastern Washington are requested to keep their respective RMs posted as to any schedules or other activities. Traffic reports should be sent to the SCM direct on the 26th of the month.

Traffic: 7KO 135, na7HL 117, na7ABE 91, 7LZ 42, 7QG 33, 7TX 30, 7AEV 29, 7AFQ 17, 7ACB 17, 7IV 15, 7RM 14, 7IZ 11, 7TZ 11, 7TJ 9, 7FD 7, 7AKU 3, 7VL 3.

PACIFIC DIVISION

SAN DIEGO—SCM, G. A. Sears, 6BQ—6AJM leads in traffic again this month. QRN in OP has interfered with message handling and oplAD has moved his station and has been off the air for over a week. 6BWI leads in deliveries this month and is handling messages from men in the fleet to folks at home. 6BAM finds QRN bad on 80 and is using 40 again. 6BAG a new ORS, piled up a nice total again. 6BYZ has resigned as RM. Business leaves but little time for radio. 6QY is now on 20 and reports it FB for DX. 7FP was off the air with the flu for a couple of weeks but he is OK again now. 6DGY is again on the air. 6BZD, a new ORS, reports schedules with si-5BX and 4ABC and has worked all continents. 6BGL reports trouble to an AC operated BCL set next door. 6AKQ has been ill since May 4th. Go and see him, gang. 6ANG is back again with a UX210 and 1000 volts. 6OX is QRW making pictures most of the time. 6BAS has been on vacation and now has the experimental call, 6XJ.

Traffic: 6AJM 362, 6BAM 110, 6BAG 79, 6BYZ 44, 6QY 28, 6FP 33, 6BZD 22, 6BGL 20, 6DGY 26, 6BQ 16, 6ANC 12, 6OX 6, 6BAS 6, 6BFE 1, 6AKQ 16, 6BWI 113.

HAWAII—SCM, F. L. Fullaway, 6CFQ—6ADH takes the traffic high score this month, making the BPL. He has been appointed RM so get behind him and push. 6CFQ is second the traffic list, also making the BPL. A lot of traffic was handled for the fleet personnel via 6BWI in San Diego. 6DJU went out on maneuvers with his portable, 6EDJ, and worked his home station handling Army traffic. Miller of 6AVL is leaving for the States. 6AVL will be operated by his second operator who has taken over the set. 6DEY, a new ORS, worked all but the third dist. on 20 in four nights. 6CLJ installed a transmitter at his high school under the call of 6EAT. 6ROE has put up a Zepp and remodeled his transmitter. 6ALM is trying to get ten to work but can't get his receiver to go. The local power

company gave 6DB some high voltage and his Rectobulbs went west but he is back on now with some new ones. 6BDL is going on a furlough so will be inactive for three months. 6DLR is going down to 20.

Traffic: 6ADH 256, 6CFQ 234, 6DJU 112, 6AVL 79, 6DEY 64, 6DB 59, 6CLJ 32, 6BOE 29, 6ALM 23, 6EDJ 11, 6BDL 9, 6DLR 3.

LOS ANGELES—SCM, D. C. Wallace, 6AM—6DKD and 6ZBJ make the BPL this month. 6DKD, portable, was the station at the Huntington Park Union High School Exhibit. 6ZBJ is just installing a new crystal. He reports that 6CMY got married this month so he won't hear from his for a time. 6JU was a welcome visitor at 6ZBJ's shack this month. 6BPO took a bunch of messages from KNT, Zane Grey's yacht, and delivered them all OK. 6DHR has just changed to 20 as it seems to be a better band here. 6COT worked France on 20 using low power, and only needs Africa for a WAC certificate. 6BSN reports that 6AAH, 6COR, 6DFM, 6CCT, 6BEM spent the week end in Fresno and 6CMY of Santa Barbara passed through on his honeymoon. 6DOW gets a speedy delivery on a message sent to Oakland. 6ABK has QSY'd down to 20 to try for a QSO with Europe. 6APW has been rebuilding trying to get a receiver that will hear more foreigners. 6BFP says he is now signing 6AX. 6EEB blew his 210's and is now using 201A's. 6AGR finds that he can use a $\frac{1}{2}$ wave Zapp for each of the bands to better advantage. 6CUT handled a death message from nc-6AC. 6DKX is still having trouble with the transmitter. 6AWQ has installed a new filter transformer and has a new tube ready to keep his part of the Section on the air this summer. 6DGT was QSO oa-ZSH on a 201A tube on 40. 6CMQ hopes to be on more now that Cal. Tech. closes PDQ. 6AEC is one of our new contributors. 6CHA has five schedules arranged but the other ops didn't come through. 6AM's portable, 6MA-6ZZA, is carried on business trips for QSO's with Mrs. 6AM. 6DMG was off the air for about two weeks but still sends in a good report. 6ANN worked 2JN on 10. 6CHT worked some DX this month. 6BVM QSY'd down to 20 for a while but the set seems to be rather radical. 6CZO has been studying for a commercial ticket. 6CZU is busy with opera at school. 6BVT is still trying to get some good schedules. 6AHS is on 20 now and says it is FB. 6DCH worked VOQ and handled one message for him. 6ASM is very busy with A.R.R.C. and checking off-wave stations. 6AKD was QSO with Australia 32 times, OZ 5 times, and AJAC a number of times. 6CUH was QSO AC, OA, OO, OH, NC, and SC in one week. 6QL reports that aj-4BK sent him a Japanese Radio magazine but can get nothing out of it. 6DEG moved his entire 40 meter transmitter to garage, remote control with relays, and his entire 80 meter transmitter to attic. 6EAF started up April 18th and has 10 cards to date. 6AKW says it is summer season and haying is taking much of his time. 6CBD is building a real 1929 transmitter and receiver. 6BZR finally finished rebuilding and is started on some real work now. 6CLK, 6PY, 6BHR, 6BRO, 6BUX, 6AJA and 6CHT report as usual. 6DHS and 6AM were QSO 9EF on 10 meters. A radio club was formed in Long Beach: 6CAE, president; 6CIK, vice president; 6CHQ, secretary; 6DOZ, treasurer. 6AEF got a big write-up in his home town paper. 6BJX is working toward having a traffic competition between the San Francisco and Los Angeles Sections. The following percentages are suggested: Promptness, QSR or delivery, 20%. Neatness of station, 10%. Traffic total, 50%. Traffic originated, 10%. Operating ability, 10%. The contest will probably begin and run until the 1929 convention. 6DPY says the radio club is coming along fine, 13 members now. 6DHU will send the OBS on 20 meters after June 20 at 8 pm. 6ALG keeps a schedule with op1PW to whom many foreign messages are directed. 6ALR has been very busy but hopes to do some real work soon.

Traffic: 6DKD 446, 6ZBJ 225, 6BPO 192, 6DHR 91, 6COT 53, 6BSN 46, 6DOW 44, 6ABK 40, 6APW 28, 6BFP 33, 6EEB 29, 6AGR 28, 6CUT 27, 6DKX 26, 6AWQ 24, 6DGT 23, 6CMQ 23, 6AEC 22, 6CHA 22, 6AM 21, 6DMG 21, 6ANN 18, 6CHT 17, 6BVM 16, 6CZO 14, 6CZU 12, 6BVT 11, 6AHS 11, 6DCH 11, 6ASM 9, 6AKD 9, 6CUH 8, 6QL 8, 6DEG 8, 6EAF 6, 6AKW 5, 6CBD 3, 6BZR 3, 6ALR 3, 6PY 2, 6BHR 1, 6DPY 8, 6DHU 7, 6ALG 113, 6ALR 11.

ARIZONA—SCM, D. B. Lamb, 6ANO—6BJF leads the state in traffic this month. 6CDU has a 900

cycle generator, 200 watt. 6BJF lost out in the BPL due to no schedules east. 6CRA is moving to San Francisco. 6AZM installed a mercury arc but shot a plate transformer. 6BWS graduated from high school so will be on the air more now. 6CPX is going to sea as a commercial operator. 6ANO and 6CDU are planning on joining the U.S.N.R. 6ANO is back with a rebuilt 6EX 50 sync rectifier. 6EAA is on with a $7\frac{1}{2}$ watt on 40 meters. 6BYG is on the air with 201A's. 6DRH, 6SW, 6CAP and 6DCQ were cancelled for failure to report and for non-membership in the League.

Traffic: 6BWS 72, 6CPX 33, 6ANO 61, 6AZM 3, 6CRA 6, 6BJF 133, 6CDU 28.

SANTA CLARA VALLEY—SCM, F. J. Quement, 6NX—6AMN will stand out first this month in delivered total unless some unforseen station comes and does the unusual. He will soon be off the air for the summer. 6BHY, President S.C.C.A.R.A., maintained his 9COS schedule this month. 6BMW, the RM and OO, reported off wave stations decreasing this month. 6BAX works everything with a 201A on 20 meters. 6DRI just put up a new stick. 6BYH is getting ready to graduate, consequently QRW radio this month. 6NX was on a vacation this month but hopes to continue his 1MK schedule. 6ALW worked Europe several times on 20 meters this month. 6AOD is very QRW. 6BNE is rebuilding his set. 6CSX moved and will soon be going at the new QRA. There are openings for several ORS in the section, all interested stations should get in touch with the SCM.

Traffic: 6AMM 460, 6BMW 36, 6BAX 11, 6DRI 7, 6BYH 6, 6NX 6, 6ALW 2.

EAST BAY SECTION—SCM, J. Walter Frates, 6CZR—Traffic fell off slightly this month on account of one of those unexplainable slumps which occur occasionally. 6CGM, however, came through in his usual style in spite of a bad power leak. Chief RM 6IP also ran up his usual quota in spite of his work on League, convention and marathon swim activities. 6DTM and 6RJ ran up their totals a trifle. 6BOY, back from one of his voyages to Australia, did good work and kept schedules with OA and NN every night. 6ALX and his bug continues a steady stream of traffic. 6DKO will be one of the new ORS shortly. OM 6HJ, formerly of San Francisco, now of Vallejo, sends in first report and says relaying by ham radio is the bunk. 6DWI, having PB time with the split Colpitta, is working most everything on well known Pacific Ocean. 6AWM hooks ac-8AG and is going into OO work on 80 meters. 6BNG comes through with a flock of traffic and plans to get more. 6AMI has been working schedules with OA, OH, WUB and NIJN. 6BZU reports still working on key click filter. 6BOY says he has the dope on a stunt to eliminate BCL trouble and to steady wave. 6EDK has moved his transmitter to top of apartment house building and is getting out in fine style. W. W. Salisbury and L. Marshall, originators of Salisbury-Marshall 10 meter transmitter, are planning lots of traffic work and experimental stuff at 6BB. 6CZR has been working OA, AJ and na-WUJ and with 6IP is turning out new Salisbury-Marshall 10 meter transmitter for reflector work with low power. 6DDQ has been QRW with school but will have more time during the summer months. 6EY has a schedule with 1MK and reports 80 meters dead lately. 6IM is back on the job but says too QRW to be on the air much. 6GLZ still holds a schedule with na-7AER and is going into OO work on 20 meters. 6CDA still works along in spite of other activity. 6RUX reports working Europe but going to Pomona for summer. He says 6EDO is a new man in Pope Valley. 6IT broke up his continuous work as OO and handled a message, first one in years. HI. He is QRW with QRM complaints and doing FB work. 6CMG is still busy with studies but expects to be on the air soon for the entire summer.

Traffic: 6CGM 287, 6IP 105, 6DTM 99, 6RJ 78, 6ROY 62, 6ALX 62, 6DKO 39, 6HJ, 30, 6DWI 23, 6AWM 24, 6BNG 23, 6AMI 23, 6BZU 23, 6EDK 16, 6CZR 12, 6AWF 10, 6DDQ 8, 6EY 8, 6IM 7, 6CLZ 3, 6CDA 3, 6BUX 2, 6IT 2.

PHILIPPINES—Acting SCM, J. E. Jiminez, op1AT—op1DR still strictly keeps the schedule with op1AH and op1HR. Static is prevalent all over the Philippines now. op1DR would like traffic going to the U.S. steamers plying the Oriental Seas. 1HR, 1DR, 1DL and 1GZ report as usual with good totals.

Traffic: 1HR 572, 1DL 124, 1GZ 8, 1DR 274.

SAN FRANCISCO—SCM, J. W. Patterson, 6VR 6DBM has deserted 40 meters for 10 and 20 using a super-het and an ultra-audion for the transmitter, incidentally he also has worked all continents. 6ARD is handling plenty of traffic. 6PN continues to hold schedules with the east coast on 20 meters. 6CXI is planning on moving his QRA to Samoa and way points. 6AWA is handling plenty of traffic and DX. He has had a bad power leak that knocks things for a loop. Not many reports this month. Let's make it 100% next time, gang.

Traffic: 6ARD 753, 6AWA 110, 6CXI 11, 6DBM 10, 6PN 8.

SACRAMENTO VALLEY—SCM, C. F. Mason, 6CBS—6CIS worked nine countries in May and has a schedule with n47TO on the way. 6DON says 80 meters is beginning to wake up again but he is going to try 10 meters. 6ATQ says not much doing on account of hot weather. He is rebuilding his receiver now. 6CRS is working on a Navy set for Mr. Babcock. He (6cbs) will be on the air with 75 watt tuned plate and tuned grid soon.

Traffic: 6CIS 67, 6DON 17, 6ATQ 4.

ROANOKE DIVISION

WEST VIRGINIA—SCM, C. S. Hoffman, Jr., 8HD —The Derby for traffic this month goes to 8CLQ. He is desirous of W. Va. schedules 8BJB got R8 while QSO WSBS. QRD 2000 miles from Washington, D. C. The next few weeks will see 8BNF, 8BBM and 8BJG home from school and on the air again. 8QH-8IT working west coast with his 210, doing some fine work. 8DCM is making a trip to Calif. taking a portable transmitter along and hopes to QSO the gang, so be on the look-out. 8AGI says someone is using his call for phone. 8DPO still works his OH gang and will be glad to QSR traffic that way. 8AWM-8HD are planning an extended trip west.

Traffic: 8CLQ 43, 8QH 26, 8DPO 24, 8BJB 21, 8DCM 4, 8AGI 2, 8HD 2, 8CDV 1.

NORTH CAROLINA—SCM, R. S. Morris, 4JR—ITS is experimenting with antennas. 4AB is going strong in spite of QRN. 4OC worked "LJ" of WSBS and reports much foreign traffic. 4SJ had a booth at the Henderson Auto Show and got considerable traffic. 4OH has been very QRW high school graduation. 4CQ has a short wave super het that really works. 4JR has been idle a great deal due to heavy QRN. 4RF, 4AEW and 4EL paid 4JR a visit. 4ADQ is trying 20.

Traffic: 4AB 192, 4OC 37, 4TS 4, 4JR 2.

VIRGINIA—SCM, J. F. Wohlford, 3CA—3KU went out for a commercial license and got it. Now expects to go to sea. 3TN and 3II failed to pass the exams for commercial licenses. 3AG claims poor DX on account of QRN, QPM and QRW from listening to HC stuff. 3EC has QRM from school. 3ALS has been issued an ORS certificate. 3BGS has QRM from his chicken farm. 3RL is installing mercury arc. 3CFY shipped to South America but returns in August. 3ANV took the first grade ham exams at Charlottesville and passed. 3BFE, 3PO, 3BHL, and 4ABE took exams, also and passed. 3NM's YL and second operator also passed the exams. 3IE is headed for New Mexico. 4ABE, one of the operators at 3NM, has returned to North Carolina. 3PO will open up at Staunton. 3ASE has gone to New Jersey. 3NM has gone to Washington and his second operator to New York City so the station will be dead during the summer months except what time the YL can put in at the station. 3AAJ is coming back on the air and seems that he is working some few stations. 3BZ works a schedule with 8CMP and 8ZZ. 3BDZ works a few stations now and then. 3CKL has been in the hospital so that the station has been doing very little.

Traffic: 3KU 19, 3AG 13, 3EC 12, 3ALS 10, 3ANV 10, 3IE 2, 3AAJ 3.

ROCKY MOUNTAIN DIVISION

COLORADO—SCM, C. R. Stedman, 9CAA—Nissen leads the traffic bunch although he doesn't make the RPL. He will be off indefinitely due to change in location. 9ENM was in the hospital half the month but has done good work since. 9CAA works Morse code daytime and Continental nights. 9CSR has a schedule with Honolulu on 20 meters. 9CCM is rebuilding the receiver. 9BQO is working again.

Director Segal has a new baby girl. Congratulations. 7AIL got married. 9ND says fishing is good. 9DQD is off the air on account of blown tubes. Davis closed a deal by radio. The Rocky Mt. Division Convention will be held August 24-25 at Pueblo. An excellent program is assured. Coday is visiting in Chicago. 9FPZ is due at Canon City. 9CTP blew his transformers. This report came by Western Union as the main report miscarried. Dick Chase is using 50 watts at 9DSB.

SOUTHEASTERN DIVISION

ALABAMA—SCM, A. D. Trum, 5AJP—Summer weather, static, examinations, spring fever, etc. seem to have kept quite a number of the gang from reporting. 5JY recently moved back to his old home in Birmingham and is leading the state for traffic, and DX this month. 5AWL was off a little this month on account of BCL repair work. 5AYL is stirring up the northern part of the state with good ham work. 5ADA rebuilt his transmitter and has it on 20 meters with panel type. 5ATS added South America to his list of DX. 5BBA, our new ham, is only 14 years old and built his first radio set two years ago. 5AJP is rebuilding and hopes to be on the air with a good set soon. 5AX is temporarily off the air.

Traffic: 5JY 154, 5AWL 11, 5BBA 10, 5ATS 12, 5ADA 18, 5AYL 14.

FLORIDA—SCM, C. E. Foulkes, 4LK—The SCM is very glad to see the large number of reports this month. Quite a number of the gang will be leaving for their summer vacations this month. 4CK is ahead this month with quite a bunch of traffic from the Shrine convention. 4AEF is putting Lakeland on the map. Traffic has been very good for 4ADB. The two ops at 4ACV keep the poor 352 pretty hot. QRM from the YL and work keep 4AAO stepping but he has some traffic. 4ACC is a new ORS with us. 4CE advises the SCM to watch the YLS in the summer, they're deadly. 20 meters is FB for 4BN. 4TK passed his commercial exam, last month. 30 meters will see 4AB again soon. Is there an Aussie that 4OB hasn't worked yet? 4MS moved to a new QRA this month. 4NE is back in S. Fla. and will be on the air soon. 4LK is off the air rebuilding.

Traffic: 4CK 259, 4AEF 89, 4ADB 63, 4ACV 58, 4AAO 28, 4ACC 18, 4IE 13, 4OO 7, 4BN 7, 4TK 4, 4ABJ 3, 4OB 2.

GA-SCUBA—SCM, H. L. Reid, 4KU—Georgia: 4PJ has done some nice work and is in line for an ORS. 4RN will be on about 24 hours a day as soon as school is out. 4GY had a nice report and handled some traffic. 4BS had fair luck with a portable and made numerous contacts in 8th and 9th district. 4PD is now an ORS and is going to do some nice work. We must have a report from South Carolina, Porto Rico and Cuba hams if you are to keep yours ORS.

Traffic: 4RN 5, 4GY 14, 4PJ 10, 4BS 6, 4PD 16.

WEST GULF DIVISION

NORTHERN TEXAS—SCM, J. H. Robinson, 5AKN —School is out and reports are picking up wonderfully. Several applications for ORS have been received and a lot have been cancelled. 5BBF handled a good bunch of traffic also did some good DX. 5OE is keeping schedules with 9BOA on 40 meters. 5AXQ and 5AQB blew their tubes trying to QSR his ORS. 5ACL is rebuilding his receiver. 5HY reports all well and still getting R8 reports. 5AKN—5BG has had heavy QRM from a can of paint and a brush but the old shack looks better. 5JA says he has been listening on ten meters for two weeks.

Traffic: 5BBF 26, 5OE 26, 5AXQ 15, 5AQB 15, 5NW 9, 5ACL 8, 5HY 7, 5AKN-5BG 2, 5JA 1.

OKLAHOMA—SCM, K. M. Ebrert, 5APG—School exams and hot weather have been getting in their work. However, a number of new stations are reporting and traffic outlook is fairly good for the summer. 5AEF, 5AYO and 5BAZ have been doing some local work on 10 meters. 5AYO works OA stations regularly on 40 meters. 5BAG has been too busy in the garden to do much on the old set. 5VH will stay on the air this summer mainly during daytime and early morning. 5BZA is using 400 volts on one 201A and one 112 hooked in parallel. 5AIR graduated from High School and says not much doing for radio. He received a letter from 3VR (ex 5FJ) who

is on his way to South America on an expedition. 5AMO has been cramming for exams and ruined his traffic records. He has a portable call, 5BCW which he will use while doing summer work for the Geophysical Research Co. 5AAV has packed his set ready to take it to Denver with him for the summer. 5AFX is doing very consistent DX work. 5QL has the crystal set going in fine shape now and working good DX. 5SW expects to put his crystal in his transmitter some time soon. 5APG still tries to work Naval Reserve schedules on 80.

Traffic: 5APG 9, 5AIR 7, 5AMO 69, 5BAZ 3, 5VH 14, 5BAG 7, 5AYO 29, 5AAV 10, 5BAE 3, 5AEF 2.

CANADA

ONTARIO DIVISION

SCM, W. Y. Sloan, 9BJ—Southern Dist; 3CS leads the Section in DX on 20 meters and is also active on 10 meters. 3CB is active on 40 and 80 meters, 3IA is QRW with business. 3AQ is the traffic station working regular schedules on 52.5, 20 and 80 meters and he sure has a fine total. 3DG is having his troubles with a power leak. 3AP has reached out and worked across the pond. Eastern Dist: 3XL has forsaken short-waves temporarily for work on the Lakes where he is now Op. on VBI. 3JW has purchased 2 fifties from 3XL. 3MD is on the air but has been quiet lately. 9CC is still on the air for prayer meetings on 52. 3XO has been assigned to Rev. Father Verrault of "Le Droit," Ottawa's French newspaper and he is expected on the air soon. 3XQ is overhauling his station. The gang wish to be remembered to 3JL who is attending college in USA. Central Dist: 3AZ has been as active as usual on 52 meters but is leaving for the North Woods and will not be on again until Fall. 3AY is going strong on 40 and 52.5. 3CJ is stepping out on 20 meters having had many European contacts. He has been appointed RM and needs your support, gang. 3DY is on 10 meters at every opportunity and reports hearing real DX. 3EQ has been very QRW with school but has managed to get on the air at times most work being on 80 meters. 3AI has been reaching out and has handled a fine bunch of traffic. 3BT is still playing with phone on 85 meters and reports fine DX. 3AL confines himself mainly to operation on 52.5 and 82 meters. He has just been presented with a new junior op. 9BJ has been ill and is going to the Island for the summer. 3FC has confined his activities to midnight work on 20 meters for work with Australia and New Zealand. Northern Dist: 3ET is having a good time blowing fivers, having blown five of them lately. 3IN and 3HE are returning from the North Woods. 3HP has been active wherever possible. Note:—Canadian stations will hereafter all be signing VE before their various calls. The VE is part of the call and not an intermediate. It is for identification, however, and is assigned by the Gov't.

Traffic: 3AQ 57, 9AI, 38, 3AI 29, 3CJ 14, 3CS 13, 3BT 11, 3AZ 10, 3DY 8, 3AY 4, 3CB 4, 3FC 4, 3EQ 3, 3ET 3.

QUEBEC DIVISION

SCM, Alex Reid, 2BE—Before this report is published, we expect our annual picnic to be over and we will be looking forward to next year's outing. It is very nice to report that there will be three new stations on the air this month. Active stations were never so numerous as at present. 3BR has schedules south, east, and west and also has a weekly schedule with 1MK. 2BB keeps daily schedules and is always open for traffic. 2AL has the flying fever and is doing his Lindbergh stuff at St. Huberts. 2AX left last week for England and France and expects to meet a number of his air friends. 2CA has his 852 perking on 20 and getting out well. 2BG is also on 20 and is surprised how easy it is to work foreigners. 2BE worked 67 foreign stations on 20 meters between April 1st and May 20th. 2CD has a wonderful wallop on 20 and should do real work with it. 2BJ will be off the air until college opens again in the fall. 2BV is leaving for the U.S.A. and will be there for at least a couple of months. 2CM is engineer in charge of the new St. Huberts Flying Field and hasn't much time to attend to pounding brass. 2HV is doing phone work for his company on 90 meters.

Traffic: 2BR 42, 2BE 15, 2BB 22, 2BW 29, 2AC 18, 2AL 9.

VANALTA DIVISION

BRITISH COLUMBIA—SCM, E. S. Brooks, 5BJ—The B.C.A.R.A.'s (9AJ) clubhouse is on the way and

the gang hope to have it completed for the Convention in July. 5CT is rebuilding again. 5BR continues to keep schedules on 80 meters and handled some traffic between KAKE and 7KO. 5AZ continues to reach out. 5CP is in line for a WAC. 5AD is working hard to get one also. 5AL is only on weekends but hands in a fair total. 5CO says 5AJ has returned from New Zealand and is going to operate on a boat. 5CJ-5CO are rebuilding separate 20-meter transmitters for quick QSY. The junior op at 5CJ inherits his dad's tendency for a bottle. 5GO is still messing around with a couple of 204's. nu-6CLS paid the SCM a visit and talked over activities here and in the south. Don't forget the convention, gang, on the 28th and 29th of July.

Traffic: 5BR 48, 5AD 30, 5AL 30, 5CO 27, 5CJ 26, 5CF 18, 5CT 9.

ALBERTA—SCM, E. J. Taylor, ne4HA—Fine weather is having some effect on our message total. 4FF leads this month and says his town is installing a.c. 4AH still does nice work but is too busy to uphold past totals. 4CU has shifted his broadcast to 20-meter band. 4HM is visiting in England. 4EP is going strong on forty with a fifty. 4BC is leaving for Ottawa this month. 4CL worked a couple of EG's but is out of town for a while. 4GT is out of town most of the time but gets in for weekend QSO's. 4HA gets a report from EG that his signals were heard there. 4AE is on 20 and works Belgium and gets R5 from England. 4GD is also on 20. 4AF is still pounding on 40 but reports no DX or traffic. 4IO is on all bands regularly. 4CC comes on for an hour daily but is hampered with YLitis. 4XO-GF bought a car and can't afford radio now.

Traffic: 4AH 6, 4FF 17, 4HA 2, 4GT 3.

PRAIRIE DIVISION

SASKATCHEWAN—SCM, W. J. Pickering, ve4FC.—The gang are beginning to be affected by the summer weather and work but summer is short, gang, so brighten up. 4AQ has been busy lately but sent in a good report. 4IH will not be on much until this fall and complains of poor weather for radio lately. 4GB has a new MOPA which he says has a kick like a mule and is going after DX. 4BM has moved to Sintaluta and has changed to a Colpitts circuit and getting good reports. 4BI, has skeds with 4GR and 4AC at noon daily. 4GR has a new 50 watter. 4CB is trying 10 meters but reports no success so far. 4HS beat the rest of our traffic reports this time but says things are slowing down.

Traffic: 4HS 23, 4CB 18, 4FC 13, 4BL 10, 4GB 6, 4BM 5, 4IH 5, 4AQ 3.

MANITOBA—SCM, D. B. Sinclair, 4FV—DX conditions were much improved this month. Several nice DX feats were accomplished. 4FV lays claim to being the first ne4 to QSO Russia. 4CT worked ef-8ORM with a 50 that he bought for \$2.00. 4GG's schedules with 8ARC brought him in a little traffic this month which is more than the rest of us can say. 4DU has been idle but has a new 20-meter set rigged up to use when he feels energetic. 4DJ-ex4JL, has a 210 perking FB and gets many R7 reports from NU. 4DI, ex4RM, also gets out FB on a 210. 4DB, ex4SD, used a fifty for a while but has graduated to a 5 watter. HI. 4GQ dragged down the R8 reports on 20 but is rebuilding and has designs on an 852. The Ultraudion circuit worked FB for 4EK. 4DW at the Pas has a daily schedule with 4FV though he is not on the air very much at other times. We have yet to hear from 4FS and 4AR. 4DK, ex4ST, uses a 202 and gets out FB on 40 and 20 meters. 4DI, ex4SS, is another 7½ watt station putting out a good signal on the 40-meter band. Another new station has appeared using a temporary call, 4NR. Listen, fellows, not a single report was received this month that I did not have to phone for. How about a little co-operation next month?

Traffic: 4GG 15, 4DL 9, 4FV 5, 4CT 2.

ADDITIONAL AND LATE REPORTS

6RAJ was sick last month so traffic was low. 6DPO's receiver went haywire before he had a chance to make the RPL. 7IY-7QA has been on 20 for the last week or so and finds it FB. 7AKK uses 20 and 40 for traffic work. He received a QSL card from ex-2BHQ the other day. 7ACS is going to Mt. Tacoma this summer with a portable set, signing 7AEE. 5TV says traffic on 40 meters is not so heavy as it was last month.

Traffic: 6BAJ 23, 6DPO 47, 7IY-7QA 9, 7AKK 278, 7ACS 4, 5TV 11.



I.A.R.U. NEWS

It has occurred to the editor of this department that it might be interesting to include here from time to time short histories of the various foreign amateur societies, with information on the early struggles of organization, later progress, achievements, etcetera. If this suggestion meets with approval we would be glad to have you say so, and steps will then be taken to get the histories.

Opportunity is taken here to solicit monthly reports from foreign amateur organizations. We receive regular notes from a number of countries, but there are many missing. If distances are too far for quick delivery by mail, it is suggested that the report be sent on a regular schedule with some NU station. We will make a note of all reports received by radio. Material should be in Hartford about the 25th of the month; it can be written in any language. When it is possible to include good photographs of notable stations, by all means do so, being sure to accompany these with station data.

BELGIUM

"DX conditions have been very good for the last few weeks and many fine contacts were realized by our hams.

"We want you to take notice that those well known stations eb4WW, 4ZZ and 4AX have joined together under the official call eb4WX and that they are pouring in very strong signals almost everywhere.

"Little work has been done lately on 20 meters, although eb4UU and 4AU worked af1B at Saigon, Indochina.

"We must call attention, too, to the work of eb4FT in establishing contact between Belgium and Madagascar, in addition to working ac2FF at Tientsin, China, and several places on the East African coast.

"Also, eb4CM worked asZAI at Vladivostok and had his phone heard in Varsovia, Poland.

"For the benefit of amateurs generally, it might be mentioned that a Dutch ship is regularly circling Africa; her call letters are xenOCP (Zero CP) and despite the fact that the input is only 18 watts the

signals are reported at good distances. This is a fine opportunity to work some unusual countries, as xenOCP is calling at almost every East African port.

"Speaking of low-power work, eb4RO with 440 volts from the d.c. mains is work-

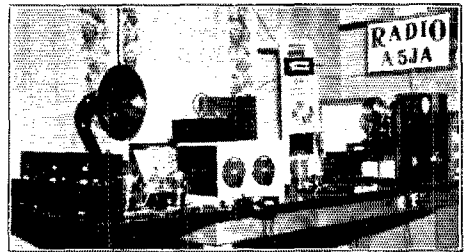

THIS IS THE LAY-OUT OF oa5JA, OWNED AND OPERATED BY P. J. BREWER, 21 DOUGLAS ST., PARKSIDE, SOUTH AUSTRALIA, WHO STARTED TRANSMISSION UNDER THIS CALL FIVE HOURS AFTER GETTING A LICENSE IN 1926

Since the first transmitter, which incorporated a 201-A, the set has progressed until at the present time the "works" consist of a UX-210 supplied with 550 volts made to closely resemble d.c. with the help of a pair of "S" tubes and a good filter system. The best antenna system tried out is a nearly-vertical wire to the top of a 50-foot pole, the antenna being worked on the 3d harmonic against ground. The receiver is a low-loss Reinartz. Oa5JA has QSO'd Australia, New Zealand, Java, Borneo, the Philippines, China, Singapore, Japan, Hawaii, the U.S.A., South Africa, Canada, France, England and Ireland.

ing every continent, as well as all districts in OA, OZ and the U.S.A.

"We want to say to our NU brothers that those ships AWL, AWV and ARCY, running between Europe and the Far East and Australia would be glad to work U.S.A. stations. They are on 31 meters, with strong 600-cycle notes.

—"Paul de Neck, President of the Reseau Belge"

ENGLAND

"British DX activities these days seem to be concentrated entirely on the 23-meter band. On this wave, 5YK has worked

(Continued on Page 70)

Correspondence

The Publishers of QST assume no responsibility for statements made herein by correspondents.



Welcome!

Radio Society of Great Britain,
53 Victoria Street, London, S.W.1.

Editor, QST:

I have been informed that many of your members will be visiting our country during the summer and I write to say that we hope they will not fail to look us up at the R.S.G.B. Headquarters while they are here. We endeavor to give all Hams a warm reception and we welcome them to our meetings during their stay in this country. Amateurs visiting London should 'phone Headquarters (Victoria 4412) when they will be put in touch with myself or some of our social Committee.

Amateurs from the United States or other countries would be particularly welcomed at our Annual Convention on September 28th and 29th when a large number of the country members flock to town and join us. At this time the British Annual Exhibition of the Radio Association will be in progress at Olympia.

—H. Bevan-Swift, Hon. Secretary R.S.G.B.

W A C too Easy

15, rue du Luxembourg,
Brussels, Belgium.

Editor, QST:

It seems astonishing to us that so many amateurs who have worked all six continents refrain from asking for membership in the WAC Club. The WAC Certificate is positively a wonderful idea and is, to its possessor, a real testimony of his ability.

We believe, however, that the value of the WAC Certificate is not equal for every continent, for we, in Europe, are in a much better position to work every continent than amateurs in America or most other countries. For instance, to work Iraq (AQ) for Asia and Algeria or Morocco (FM) for Africa is child's play with about 50 watts input and, with that power, it is not difficult to connect with NU, SB or OA Hams.

What a difference it makes for a New York amateur who has to work Asia! It is just as if the European amateurs had to work the 6th or 7th district to get their NU contact.

If the Europeans had to work China or at least Indo-China for their Asiatic contact and South or Central Africa for their

African contact the significance of the WAC Certificate would be more nearly equal for all countries.

—G. Neelemans, eb4FT, Traffic Manager of the Reseau Belge.

Those Band Jumpers

South Hibbing,
Minn.

Editor, QST:

For about thirty days, I have been off the air waiting for some high voltage rectifiers and have spent the time listening nightly to amateurs all over this and foreign countries. Some curious practices have been observed. Many stations have been heard, for instance, making adjustments and alterations, apparently without a wavemeter, and making their first CQ with a borrowed or 'phony' call. If heard and answered by another station they have not 'come back' at him but have waited a few minutes before starting up again and calling CQ with their rightful call. I have heard this procedure in almost every District and it does seem strange that the amateur must adopt such a pitifully childish practice to protect himself from the 'off-wave' cards of Official Observers. Others who are not certain of their wave send 'ABC de' and their call without the district number hoping against hope that someone will answer them. Surely these Hams are not such dumb animals that they cannot find their transmitter wave on their receivers, or cannot rig a coil and condenser to be calibrated roughly from their receivers and used to check the transmitter by the plate current 'dip' method. If one stops to listen to these off-band babies signing a borrowed call one cannot help wondering what will happen to the amateur game if this sort of thing keeps up.

—Wm. J. Ryder, Jr., 2C1Y-CSU

Off Wave

Racine,
Wisc.

Editor, QST:

After re-calibrating my receiver and frequency meter last night I listened to a bunch of outlaw stations, both above and below the 40-meter band, bouncing along merrily evidently ignorant of their wavelength. The strange part of it was that

CROSLEY

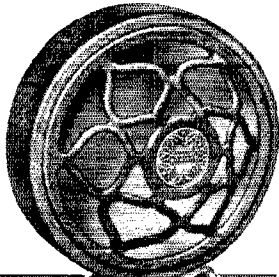

New Dynamic Speaker
DYNACONE
\$25

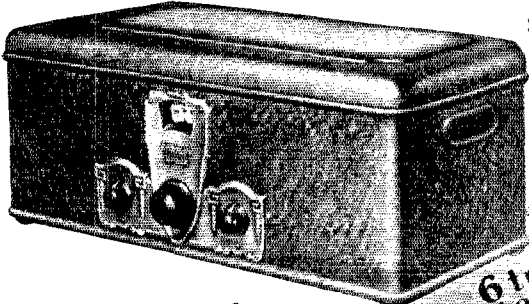

The first AC set of any type ever offered at so low a price. Highly selective; coils shielded; illuminated dial; genuine Neutrodyne; powerful, efficient, proven! \$65



The crowning achievement in a history of successes!

6 tube AC Electric
GEMBOX
\$65

Features of the 1928-29 Crosley Radio Receivers

Genuine Neutrodyne radio amplification.

Complete shielding which adds so greatly to the amazing selectivity of Crosley receivers.

Full voltage delivered to the plates of the tubes.

A sensitivity that delights the "old" radio fans and thrills the new ones by the ease with which weak distant stations are brought in.

Positive volume control reduces volume without detuning set.

Adaptability to any type of console.

Modern illuminated dial.

Beautiful gold and brown finish of receivers and matching Musicone and Dynacone delight the eye.

MUSICONE \$15
The famous Musicone still leads the world as its greatest magnetic type of speaker.

HERE, in a new line of radios for the season of 1928-29, Crosley presents VALUE such as Radio has never seen . . . an engineering triumph in quality . . . a production miracle in price.

These values are yours today because of the powerful advantage gained through study, work and development acquired in the Herculean task of building and selling nearly 2 million pieces of radio apparatus.

Satisfied by laboratory and actual home installation comparisons that Crosley radio has NO equal Crosley NOW makes it possible for every prospective radio owner to know how well Crosley radio will perform in his or her home before they buy.

5 DAYS FREE TRIAL IN YOUR OWN HOME

This is the NEW way . . . the CROSLEY way to buy radio. First advertised nationally by Crosley last April.

Study the sets shown at the right. Then go to the nearest Crosley dealer. Ask for a FREE trial. Over 18000 Crosley dealers serve the United States, but if you cannot locate one near you send us this coupon and we will arrange a home demonstration for you at once.



The 8 tube AC Electric Jewelbox
Genuine Neutrodyne; self-contained; full 180 volts on output tube plates; two 177 output tubes, push-pull; illuminated dial Acuminators. \$86



The 8 tube AC Electric Showbox
A new completely shielded genuine Neutrodyne, self-contained receiver; illuminated dial; full 180 volts on the plates of two 177 output tubes, push-pull. \$80



The 6 tube Improved Battery Type BAMBIX
Neutrodyne; shielded; illuminated dial; Acuminators. Unequaled in its field. \$56



The 5 tube Dry Cell Operated BAMBIX Jr.
Modern radio reception for places where electric current is not available or storage battery recharging is inconvenient. \$35



USE THIS COUPON FOR FREE TRIAL
THE CROSLEY RADIO CORPORATION, Cincinnati, Dept. 18
I want to know more about Crosley Radio. I want to take advantage of your offer to let me try one 5 DAYS FREE IN MY OWN HOME. I cannot locate the nearest Crosley dealer so please arrange a demonstration for me. Send set Send literature

Name

Address

The Crosley Radio Corporation, Cincinnati, Ohio
Powel Crosley, Jr., President
Montana, Wyoming
Colorado, New Mexico and West prices slightly higher.

Say You Saw It In QST—It Identifies You and Helps QST

Get into the COMMERCIAL RADIO FIELD where the MONEY IS

We've had hundreds tell us that they knew radio backwards and forwards. Yet they enrolled in our courses. And a few weeks after they started to learn radio the RIGHT way these same men told us that they never realized how much they had been missing right along.

Maybe you too have sufficient radio knowledge to build a few radio circuits. That isn't enough to make a real commercial success. What you really need is a course that takes you from the first elements of radio right through the most complex stages and gives you the practical knowledge you need for commercial work.

RADIO INSTITUTE SPONSORED BY RCA, G-E AND WESTINGHOUSE

The Radio Institute of America is the world's oldest radio school, giving the finest and most comprehensive instruction obtainable. Our graduates are making real money—we'll send you copies of some of the letters they write us about their successes.

STUDY AT HOME

Another feature of this course is that you can study at home—when you please and as long as you please. No need to give up your present employment. No time lost traveling back and forth to classes. Our new booklet tells how others—just like yourself—have won success in radio, and how you too can make this profession of fascinating brain-work your life career. You owe it to yourself to read this book through. If you will clip and mail the coupon, we'll send the book to you.



RADIO INSTITUTE OF AMERICA Dept. D-7
326 Broadway, New York City

Please send me your booklet.

Name

Address

.....

standard frequency transmissions were in progress and it is quite certain that 9XL could have been heard by any one of the outlaws had they wanted to listen.

I can see a sad end for these clumsy goats who are constantly jumping the fence, and unpleasantness for all of us if they are permitted to continue. I fail to see the possibility of even a feeble excuse for band-jumping on the part of any station when we have a splendid standard frequency service such as that of 9XL and when the checking of the station frequency within the station is such a simple matter. Let us find some means of running down these 'vandals' however drastic it may be.

—A. V. Raught, 9DTN

We'll Say So!

611 E. Gibson Ave.,
Connellsville, Pa.

Editor, QST:

You can't keep a good Ham down (in frequency). We may be hampered by next year's regulations but watch history repeat itself. Everything below 13.1 is either the amateurs or is un-reserved. Once the big fellows thought that everything below 200 was useless—and they had another thought coming. It won't be long now 'till they have another. Fellows, let's make this one a real humdinger.

—J. Craig

Bouquet

236 W. 114th St.,
New York City.

Editor, QST:

I write to praise your League and especially your member 2WI who is responsible for one of the happiest days of my life.

After having been away from my folks for ten years with the mail as the only means of communication, 2WI and his station, with the cooperation of Mr. M. A. Gonzalez of Costa Rica, has given me the chance of communicating directly with my father. There are no words to express my appreciation of this wonderful favor done for me by amateur radio.

More power to you fellows!

R. A. Canas

Off Wave

Cambridge, Mass.
20 Prescott St.,

Editor, QST:

I am much interested in the problem of off-band operation for it seems to me that we must give the matter earnest and serious consideration if we hope to make an effective stand against further inroads into our territory.

Every time an off-wave amateur goes on the air he is weakening not only his own position but that of us all.

NEW GOULD

The New and Improved Gould Kathanode Unipower type AC-6K (6 volt). Automatic "A" Power Unit with built-in relay. Throws the charger on and off and controls a "B" Battery Eliminator if one is to be used.

Fundamentally different from any other automatic charging "A" power device on the market. Its Kathanode construction insures longer life and is an exclusive patented feature, be-

AUTOMATIC RADIO "A" POWER

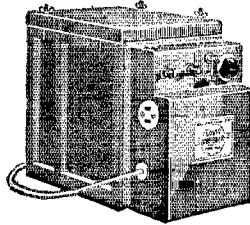

LIST PRICE, \$39.50
EXTRA SPECIAL \$15.50

KATHANODE UNIPOWER

ing used by the U. S. Government in their submarine batteries which are furnished by Gould. Its high capacity makes it especially adaptable to heavily worked or power tube sets.

Equipped with the new noiseless Balkite Charging Unit, which has four graduated charging rates, and in addition one booster rate (1½ amps.), which always keeps the battery fully charged.

Operates on 110-120 volt, 60 cycle A. C.

HIGH VOLTAGE FILTER CONDENSERS

Manufactured by Dubilier Condenser & Radio Corp.

1¼ mfd. 1000 volts rated D. C. Working Voltage

Special \$1.35 ea.

7 mfd. 600 volts rated D. C. Working Voltage

Special \$3.50 ea.

Manufactured by Stromberg-Carlson Tel. Mfg. Co.

3½ mfd. 600 volts rated D. C. Working Voltage

Special \$1.75 ea.

Manufactured by Radio Corp. of America

2 mfd. 300 volts rated D. C. Working Voltage

Special 65c ea.

(Used but guaranteed as rated)

All of these High Quality Filter Condensers are new unless otherwise specified. They are excellent for use in your Transmitter, Eliminator or Experimental Work.

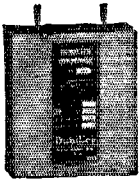

UNI-RECTRON POWER AMPLIFIERS

MODEL AP-935



As the Uni-Rectron stands it is a super power amplifier, which can be used in connection with any radio set and loud speaker. Binding posts are provided for input to the Uni-Rectron and output to the speaker. Requires no batteries for its operation. It obtains its power from the 110 Volt, 60 Cycle alternating current lighting circuit of your house.

The UX-210 super power amplifying tube and the UX-216B or 281 rectifying tube are used with this amplifier, which cannot overload. From the faintest

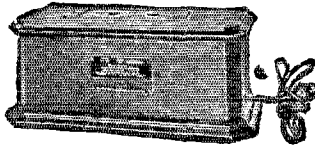

LIST PRICE \$88.50
(Without Tubes)

Special \$19.75 EA.

whisper to the loudest crash of sound—R.C.A. Uni-Rectron amplifies each note at its true value. High and low notes are all treated alike.

The volume and quality delivered will be a revelation.

Also by removing the input and output transformers it can be used as a source of power for an oscillating or transmitting tube, furnishing power for all circuits, grid, plate and filament and is the cheapest form of Power Supply for Amateur Transmitting purposes ever offered. New.

SCANLAN A. C. FILAMENT TRANSFORMER

This Scanlan A.C. Filament Transformer fills a very definite existing need for an accurate and reliable Transformer. Will not overload or heat up. Used in conjunction with an A.C. Cable Harness such as Eby, Carter, Naaid, Enterprise, Sterling, etc. which makes an ideal combination for converting battery sets to A.C. operation. No rewiring necessary. For 110 volts, 50-60 cycles A.C. Green crackle finish case. Size overall 3½x4x4.

LOOK AT THESE FEATURES!

1. Absolutely correct voltage.
2. All voltages center tapped.
3. "B" Eliminator Plug-In.
4. Sturdy and Compact.

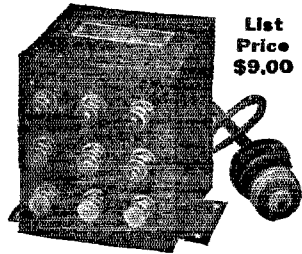

List Price \$9.00

SPECIAL AT \$4.00 EA.

LAST MINUTE SPECIALS

E210 BRADLEYSTATS, list \$4.00	Our Price \$1.60 ea.
G. E. V. T. 14-5 Watt Transmitting Tubes	\$1.50 ea.
MESCO Wireless Keys, list \$2.00	" 95c ea.
U. S. ARMY Aeroplane Spark Transmitters, Gov. cost \$47 each	" \$4.75 ea.
G. E. Kenotron Rectifying Tubes (type T.B.1)	" \$1.25 ea.
Eby A.C. Adapter Harness with Volume Control. Converts a D.C. Set to A.C. when used in conjunction with a Filament Transformer.	" \$4.50 ea.
For 5 tube sets, list \$9.00, . . .	" \$5.00 ea.
For 6 tube Sets, list \$10.00 . . .	

AMERICAN SALES CO., 19-21 Warren St., New York City

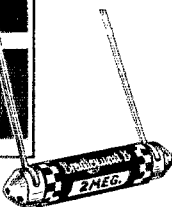
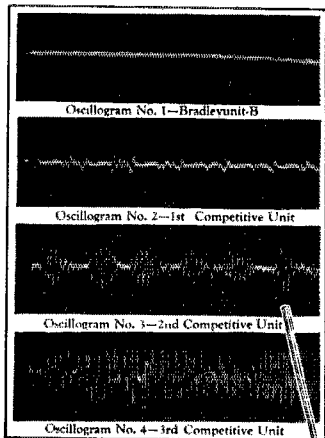

Use Grid Leak Resistors That Are Noiseless!

Not all the noise in radio receivers is "static." Some of it may be caused by "noisy" grid leaks. The above oscillograms show the disturbances in a radio amplifier circuit caused by grid leak resistors. Compare the almost noiseless performance of the Bradleyunit-B, shown in Oscillogram No. 1, with the crackling, hissing interference created by the three inferior grid leaks whose performances are recorded in Oscillograms No. 2, No. 3, and No. 4.

These tests are the best evidence of Bradleyunit-B superiority for grid leak and other radio service. For perfect operation use them in your radio circuits.



Bradleyunit-B for Radio Manufacturers

These remarkable solid-molded resistors are practically unaffected by moisture. They do not depend upon a glass enclosure for protection. Can be furnished with or without leads for soldering. Made in values from 500 ohms to 10 megohms.

Tapped resistors also offered to meet your specifications. Write today.

Allen-Bradley Co., 277 Greenfield Av., Milwaukee, Wis.

Allen-Bradley Resistors

I recommend the immediate publication of a *QST* 'Blacklist' which could be supplied by officially appointed stations detailed to guard our own interests. Any station appearing in this list should be boycotted for the current month that it happened on this list and as long as it remains there. If all stations and *foreign stations in particular* would refuse to work with off-band stations I believe that the trouble would soon be rectified. Private clubs adopt the practice of posting all members who have unpaid dues. There is no doubt that a monthly list of off-wave pirates, published in a conspicuous place, would have a splendid psychological effect.

—Thomas R. Pennypacker, 1VR

Mr. Terrell Commends Us
DEPARTMENT OF COMMERCE
RADIO DIVISION
WASHINGTON

May 24, 1928

Mr. K. B. Warner, Secretary
American Radio Relay League, Inc.
Hartford, Conn.

Dear Mr. Warner:

I have the pleasure of acknowledging receipt of your letter of the 21st instant together with a copy of the current issue of "*QST*" containing an article to which my attention has been invited with reference to the activity of the Twin City Vigilance Committee headed by Mr. Carleton H. Kohler. I get the impression that this Committee has voluntarily undertaken to make Minneapolis and St. Paul model cities from the radio listener's standpoint and to relieve the Supervisor of Radio of many of the interference complaints which would otherwise be sent to his office.

I consider this a commendable step in the way of cooperation beneficial to the listener-in, to the users of electrical devices causing interference, to the amateurs and particularly to the Radio Service of the Department of Commerce. I hope the idea will spread to other cities and that the amateurs throughout the country seeing the good work of the Twin City Vigilance Committee may set up similar committees with the same objects in view. This will do much to remove the false impression existing in the minds of many listeners-in that all interference is caused by amateur operators and there is no good reason for their existence.

I hope you will find space in future issues of "*QST*" to encourage this plan by reporting any new organizations, the work accomplished and some expressions of appreciation which these committees should obtain where relief has been afforded.

I desire to go on record as one who fully appreciates this voluntary activity of the amateurs.

Respectfully yours,
W. D. Terrell,
Chief, Radio Division



Listen to the Stromberg-Carlson Sextette Tuesday evenings at 8 o'clock Eastern Daylight Time, through the NBC and Associated Stations: WJZ, WBZ-WBZA, WJR, WBAL, WHAM, KDKA, WREN, KYW, KWK, WSB, WTMJ, WMC, WCCO, K'VOO, WFAA, KPRC, WOAI, WHAS, WBT, KOA.

Tone Quality

*unsurpassed in Radio
—now available in
Recorded Music*

PHONOGRAPH records "come to life" through your Stromberg-Carlson Receiver.

The living voice of speech and music breathes once more, as originally recorded, through the audio system of your Stromberg-Carlson, bringing the wealth of tone due to today's radio-perfected transmission of sound waves.

To play records interchangeably with radio reception through a Stromberg-Carlson, you merely add to your standard phonograph the new Stromberg-Carlson magnetic pick-up outfit—then push the pick-up plug into a jack provided in the Receiver. The operating power is from the house-lighting circuit just the same as for radio—the tone of the record reproduction has all of radio's living beauty.

[Every new Stromberg-Carlson has handy jack to facilitate playing phonograph records.]

**Stromberg-Carlson Telephone Mfg. Co.,
Rochester, N. Y.**

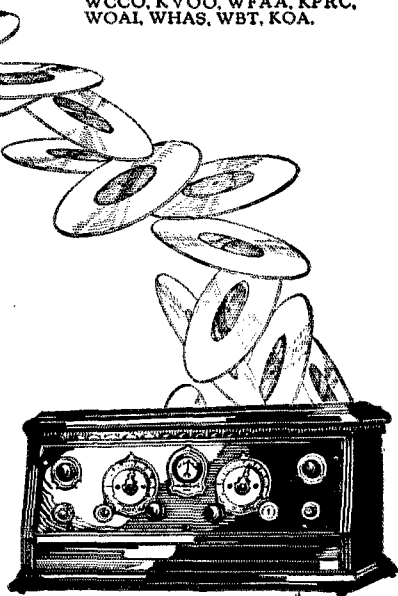

Stromberg-Carlson Receivers.

Complete for A. C. house current operation. East of Rockies \$275 and up; Rockies and West \$315 and up; Canada \$390 and up. No. 23 Stromberg-Carlson illustrated.

A new 22-inch Seamless Cone Speaker. Complete with long cord—

Price, No. 10 Pedestal Type, East of Rockies \$40; Rockies and West \$44; Canada \$50.

Price, No. 11 Wall Type, East of Rockies \$35; Rockies and West \$38; Canada \$45.

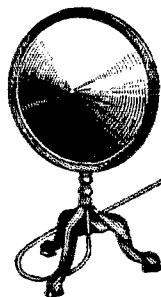

Stromberg-Carlson

MAKERS OF VOICE TRANSMISSION AND VOICE RECEPTION APPARATUS FOR MORE THAN THIRTY YEARS

Say You Saw It In QST—It Identifies You and Helps QST

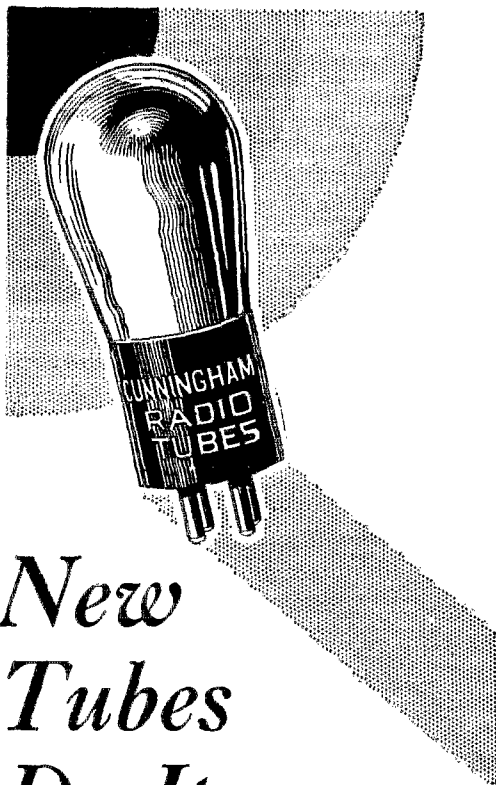

New Tubes Do It

You can give new life and energy to your radio by replacing all the old tubes with correct, modern, Cunningham Radio Tubes.

Instead of "crippled" performance from your present set, try this simple method and see how beautifully it works. Your dealer will recommend the correct tube for each socket, ask him.

E. T. CUNNINGHAM, Inc.

NEW YORK CHICAGO SAN FRANCISCO

Manufactured and sold under rights, patents and inventions owned and/or controlled by Radio Corporation of America

Cunningham
RADIO TUBES

Guarding Our Bands

The following correspondence contains, we believe, a clean-cut statement of the position of the League with respect to the newspapers who are improperly using amateur station licenses in the prosecution of their business, and it therefore is published for general information of the membership. Members are also referred, in this connection, to our June editorial.—Editor.

UNITED STATES FLEET, BATTLE FLEET
BATTLESHIP DIVISIONS
U.S.S. CALIFORNIA

Honolulu, T. H.
May 2, 1928

The American Radio Relay League
Hartford, Connecticut
Dear Sirs:

The New York Times station 2UO broadcasts excellent press items each day at 1:00 a.m., E.S.T., on a frequency of about 7000 kcs. These items are especially desirable, as the news is that which is printed in the morning Times of the date of transmission.

Our reception of this press is frequently interfered with by amateur stations operating on the same frequency. The interference is purely accidental, and I am sure that all amateurs would carefully avoid interfering with this schedule if you would print a notice in QST asking them to keep off this frequency during the press transmission, which lasts about one hour.

The opportunity to copy this schedule without interference will be appreciated by all operators afloat.

Yours very truly,

R. E. Melling,
Lieut., U.S. Navy.
Radio Officer.

May 17, 1928

Lieut. R. E. Melling, U.S.N.
Radio Officer U.S.S. California
via San Francisco, Calif.
Dear Lieut. Melling:

I have your letter of May 2nd from Honolulu in which you say that amateur stations interfere with the reception of news broadcast by the New York Times Station 2UO on a frequency of about 7000 kilocycles, and asking if we would print a notice in QST asking amateurs to keep off this frequency during this transmission.

I have been the secretary of the amateur organization for over nine years and I have no recollection of any request from a Naval official in recent years, whether the matter be slight or large, to which we have not been happy to accede immediately. But I regret that in this matter we can take no action upon the line you propose. I would like to explain this.

The New York Times station is operating under an amateur license, on amateur wavelengths and of course with an amateur call. It is our opinion, and that of the amateur body generally, that the New York Times has no right to an amateur

Aluminum Contributes to Radio

—Lightness, Beauty, Finer Results

MANUFACTURERS of the finest sets are using Aluminum in constantly increasing quantities. Their tests have demonstrated that Aluminum is the *one* metal that most efficiently meets the widely differing conditions encountered in radio design.

Its lightness; its permanent beauty; the fact that it does not rust or corrode; its high electrical conductivity; its efficient shielding quality; its "workability"—all are advantages that combine to make Aluminum the ideal metal for radio.

IN many of the most advanced receiving sets Aluminum Shields are used to achieve better tone quality, greater selectivity, closer tuning—in short, finer reception.

Aluminum shielding reduces interference. It eliminates electrostatic and electro-magnetic interaction between various stages of radio-frequency amplification. It eliminates modulation of radio frequency stages by feed-back from audio-fre-

quency amplifier. It makes possible more compact design.

Aluminum performs these functions efficiently and adds less to the weight of the set than any substitute metal. Moreover, it is easily worked into special shield shapes—cans, boxes or casings. Thus it presents few limitations of size and shape.

It allows the engineer great freedom to design his shielding to meet, ideally, the various requirements of his set.

ALUMINUM is widely used for variable condenser blades. Aluminum Company of America produces special sheet Aluminum for this purpose that is accurate and uniform beyond anything hitherto attained. Gauge tolerance in thickness is $\pm .001$ inch and the *total* variation within one sheet is limited to .0005 inch.

Aluminum Company of America also makes finished condenser blades from this highly accurate and uniform sheet.

THE leading manufacturers of foil and paper fixed condensers now use Aluminum foil because of its high electrical conductivity and its great covering area (a pound of Aluminum foil .0003 inch thick covers 34,000 square inches). Terminals can readily be soldered to Aluminum foil condensers by a process recently developed by Aluminum Company of America.

ALUMAC Die Castings of Alcoa Aluminum combine lightness, strength, accuracy and high conductivity. They have equal strength with *less than half the weight* of other casting materials. They are used with complete success for loud speaker frames and bases, condensers and condenser frames, drum dials, chasses—and even for cabinets.

There is a fund of information on the use of Aluminum in radio, and on radio in general, in the new edition of "Aluminum for Radio." Your copy of this interesting book will be mailed on request:

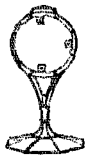
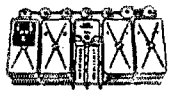

ALUMINUM COMPANY OF AMERICA

ALUMINUM IN EVERY COMMERCIAL FORM
2439 Oliver Building  Pittsburgh, Pa.

ALUMINUM

The mark of Quality in Radio

And Now!

THE THIRD
EDITION of the

Radio Amateur's Handbook

in
STIFF
BUCKRAM
BINDING

Lies open and flat at any page

The invaluable Handbook with attractive and durable maroon leather cloth covers.

Will Wear Like Iron.

Price \$2 postpaid anywhere

A. R. R. L.,
Hartford, Conn.

Stiff
Binding

Gentlemen:

I've been wanting a better bound copy of the Handbook for a long time. Here are my two dollars.

license. They are not operating an amateur station; they are operating a limited commercial station under an amateur license. It is an adjunct to their business and contains the pecuniary interest the absence of which is the distinguishing mark of the amateur. The broadcast service they render is done in forthright violation of a regulation which specifically prohibits the broadcasting of news by amateur stations. This service is undoubtedly of value but it ought to be done on a wavelength outside the amateur band. The League now has protests on file at Washington against the licensing of this station to operate in the amateur bands; the New York Times similarly has application pending for a limited commercial license; it is to be expected that in the near future such license will issue and that they will then have a channel free of amateur interference. Every amateur regards the present 2UO as an interloper and amateurs cannot be expected to abandon any of their rapidly dwindling frequencies to a station which improperly masquerades as an amateur station and then goes outside the law itself in doing things which are denied stations operating under amateur license.

I cannot tell you how much I regret that our office cannot act on this suggestion from a naval officer, with whose department we have only the most pleasant and cordial relations. I trust that you will understand.

Sincerely yours,
K. B. Warner
Secretary-Editor

I. A. R. U. News

(Continued from Page 80)

nu6BQ, his first 6, and 0A, 0Z and AL. 5YX is QSO the sixth and seventh districts and 0A and 0Z, being R8 in all continents. Both these stations are crystal-controlled, although 5YX has not yet got his going quite OK. 5HS has worked heaps of West Coast stations, including na7ADY and nc5AW. He is looking around for 0H now. 6YQ, with nine watts input, has worked 0H and NA, as well as the sixth and seventh districts and 0A and 0Z. That's real QRP work. 5BY and 5MA are too modest to say anything, but they have been heard QSO nu6 and nc5 and 0H. 5ML has worked nc5AW, nrCTO, sc2AS, am1AB, a12KT and quite a few 0A, FO and NU stations. Others busy on 23 meters are 2OD, 5AD, 2NH, 6OH, 6QB, and 6VP.

"5LS has been heard on 45 meters and 6CL managed to reach the States a dozen times on this wave recently, a somewhat unusual experience for him. 2XV had a very good month, working the sixth and seventh districts and NC. He has now increased power to 75 watts on 23 meters and wants skeds with the 6th and 7th between 0400 and 0600 GCT during week-ends only. His QRA is 117 Victoria Rd., Cambridge. 2HJ wants to know if 9FLY is a bootleg call! (No—it is quite reg-

Transmitting Kits and Power Supplies

A Real Transmitter That Has Proven Itself!

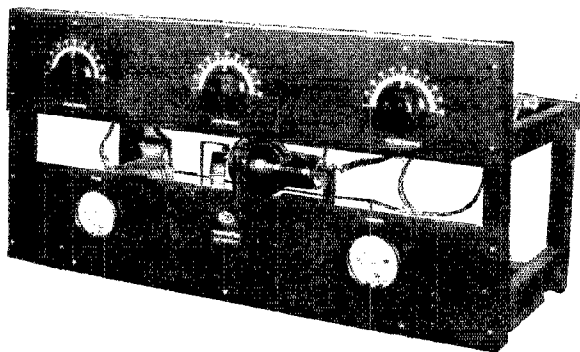

The Tuned Plate Tuned Grid, pictured, equipped with the new REL Super Condensers as well as the universally known Transmitting Inductances, is one of the best buys in Radio today! This kit has proven to be one of the most popular known.

TUNED PLATE TUNED GRID
 7.5 Watt Kit using
 UX210 \$71.00
 75. Watt Kit using
 UX852 80.00
LOOSE COUPLED HARTLEY
 7.5 Watt Kit using
 UX210 \$56.00
 75. Watt Kit using
 UX852 68.00
M. O. P. A.
 7.5 Watt Kit using
 2 UX210's \$86.00
 75. Watt Kit using
 2 UX852's 96.00

—PRICES OF LARGER KITS
 GIVEN UPON APPLICATION—

Efficient Power Supply for Transmitters Is Afforded by This Typical REL Unit

The Cat. 172 is a complete Rectifier Unit supplying both plate and filament voltages at the following ratings:

Plate supply 2000 volts
 D.C. at 300 watts
 (150 MILS)

Filament supply 10
 volts A.C. at 80 watts
 (8AMPS)

Employs standard UX-
 852 tube which is not
 supplied. Price \$85.00



The Cat. 185 rectifier unit is one for lower power transmitters and the output ratings are as follows:

Plate 400 volts D.C. at 40 Watts (100 MILS)

Filament 7.5 Volts A.C. at 2.5 Amps.

Employs one UX231 tube which is not supplied.

Price \$38.00

Radio Engineering Laboratories
 100 Wilbur Avenue
 Long Island City
 N. Y.

JUST OFF THE PRESS

thoroughly revised; right down to the minute; much new material never published; greatly improved and enlarged; no advance in price.

FOURTH EDITION

"Radio Theory and Operating"

By

MARY TEXANNA LOOMIS

President and Lecturer on Radio, Loomis Radio College. Member, Institute of Radio Engineers.

Copyright in U. S. and Great Britain.

Nearly 900 Pages. Over 700 Illustrations

Beautifully bound in Flexible Red Kraft Leather, stamped in gold.

Complete text and reference book on radio with special chapter on "Aircraft Radio" and much European material added, especially British. The first edition of this book was published in July, 1925, and since that time has been used as a text by practically all the leading radio schools in the United States and Canada, by many universities, technical colleges and high schools, and by all the United States radio schools of the Army, Navy and Coast Guard, also a reference book of the Department of Commerce. It has long since been recognized as

AMERICA'S STANDARD RADIO TEXT BOOK

and has had the largest sale of any radio book on the market during the last three years. It contains a wealth of practical, systematically arranged, and sympathetically presented information. This book, so different from other works on the subject, is understandable, and interesting, not just page after page of dry theory. The author has received hundreds of letters from educators, radio experts and fans from all parts of the world praising the book in highest terms. It seems to have filled a long felt want in the line of radio text and reference books. Each edition has been a great improvement over the preceding edition, but the latest edition (4th) far surpasses any of them. It is a library in itself and you should have a copy, if interested in radio.

PRICE \$3.50

Postage Paid to All Countries

For sale in nearly all bookstores in the United States, also in Shanghai, China; London, England; Melbourne, Australia; Wellington, N. Z.; Calcutta, India; Honolulu, T. H.; Manila, P. I.; Vancouver, B. C. Buy of your bookdealer, or send check or money order to

LOOMIS PUBLISHING COMPANY
Dept. 5 Washington, D. C.

YAXLEY

APPROVED RADIO PRODUCTS

Special Switches

There are almost limitless possibilities for different spring arrangements with Yaxley switches. Write for prices on special switches, giving as much information as possible, together with sketch of spring arrangement wanted and thickness of panel.

YAXLEY MFG. CO.

9 So. Clinton St.

Chicago

ular—Ed.) He has been hearing 'em on 40 lately, which seems unusual these days.

—*K. E. Brian Jay, eg2HJ*

GERMANY

"During last month it was quite noticeable that reception conditions got worse on 40 meters as well as on the lower bands, here in EK. In spite of this fact, some fine DX was carried out by 4VR, who on 30 meters had several QSO's with NU hams, using 7 and once even 4 watts only.

"4QM reports some good results on 32 meters, and got in touch with ne8AE on an input of 8 watts.

"4XAD (ex4LV, Stuttgart) constructed a fieldmeter for short waves and won first prize in a German ham apparatus competition held in Berlin.

"4UAD (Munich) continues his picture transmissions on 80 meters, crystal control. Foreign reports are wanted.

"At our 3rd annual convention in Dresden, two lectures were given, one by Professor Esau on 5-meter work, and one by Mr. R. Urtel on the M.O.P.A. circuit.

—*Curt Lamm, ek4AFA*

IRISH FREE STATE

"GW stations are anxious to make contacts, if possible, with NU 5th, 6th and 7th districts. Any station anxious to arrange tests or schedules with GW should apply to the Wireless Society of Ireland, 12 Trinity St., Dublin, C. 1, to which address QSL cards may also be sent.

"About 14 of the 20 licensed stations are now active and are all doing good work. Wavelengths used are 45 and 23 meters.

—*H. Hodgens, Hon. Sec. W.S.I. (GW-12B)*

NORTHERN IRELAND

"Several new stations have appeared on the air in Northern Ireland recently and there are now 28 licensed transmitters in this area, the great majority of these being licensed for a maximum input of 10 watts.

"There has been little activity among the higher-powered stations but several of the low-power men have been doing excellent work. There seems to be some friendly rivalry between 5MO and 6YW in Belfast working on 23 meters and 5WD and 6WG in Coleraine working on 45 meters as to which can put up the greatest score of NU stations worked. All four stations have already lengthy lists of NU QSO's to their credit with only a few watts input.

"2IT is now using a Mesny circuit with two 40-watt valves on 23 meters and reports that it is "the goods". 6MU has been almost entirely QRT owing to other work, but two nights on 20 meters resulted in about a dozen QSO's with the NU West Coast.

—*E. Megaw, gi6MU*

U.S.S.R.

"Here are some notes on the DX conditions here. During the first few months of the year some contacts with U.S.A. sta-

CARDWELL CONDENSERS

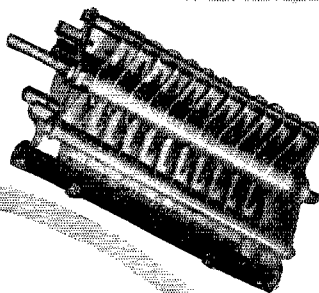

"From Greenland's Icy Mountains To India's Coral Strand"

*Instant Communication Is Made Possible
Through the Miracle of Radio!*

BUT the infinitesimal flow of energy conveying the signals must be launched into and plucked from the limitless ether by apparatus delicately attuned to its purpose.

When resistance and losses are kept to a minimum, decreased power and longer range are made proportionately more possible.

CARDWELL CONDENSERS

will insure you a measure of success undreamed of if you are one still addicted (to quote a merry old wit) to matching against known and unknown natural phenomena and the elements, "an obfuscated collection of fragments" for receiving or transmitting.

"THERE IS A CARDWELL FOR EVERY TUBE AND PURPOSE"

High Voltage Transmitting Condensers
Transmitting Condensers for Medium and Low Power
Air Dielectric Fixed Condensers
Receiving Condensers

Literature Upon Request

The
Allen D. Cardwell
Manufacturing Corp.
81 Prospect St., Brooklyn, N. Y.

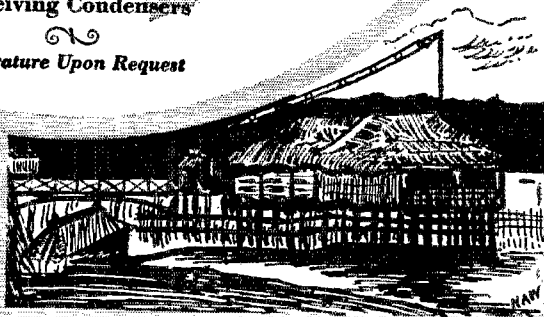

"THE STANDARD OF COMPARISON"

How to be a commercial Radio Operator

A practical book that should enable anyone of average intelligence to pass the Government's theoretical examination given to applicants for a Commercial Radio Operator's License.

NEW!

Nilson and Hornung's PRACTICAL RADIO TELEGRAPHY

380 pages, 5x8, 223 illustrations
\$3.00 net, postpaid

The book covers in detail the theory and practical operation of every type of modern, 1928, commercial arc, spark, and vacuum tube transmitter. It furnishes complete data on commercial vacuum tube receivers. It covers everything from elementary electricity to the practical operation of radio compasses.

Some outstanding points

1. Very little mathematics;
2. Assumes no prior knowledge of electricity;
3. Covers everything in commercial radio in detail;
4. Complete list of self-examination questions;
5. Simple, yet rigidly accurate;
6. Complete wiring diagrams given.

See the book before you purchase. Fill in and mail just this coupon.

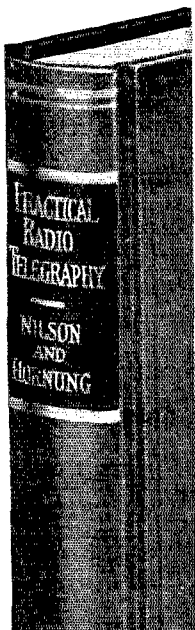

McGraw-Hill FREE EXAMINATION COUPON

McGraw-Hill Book Co., Inc.,
370 Seventh Avenue,
New York, N. Y.

You may send me Nilson and Hornung's PRACTICAL RADIO TELEGRAPHY, \$3.00 net, postpaid. I will either return the book, postage prepaid, in 10 days, or remit for it at that time.

Name
St. & No.
City
State
Name of Employer
Official Position
(Books sent on approval in the U.S. and Canada only) QST. 7-1-28

Transformers

and
Chokes



Of course Acme builds them. Acme products are nationally known.

Furnish us with your blue prints and specifications for prices.

We invite your inquiries.

Member R.M.A.

The Acme Electric & Mfg. Co.

Established in 1917
1653 Rockwell Ave., Cleveland, Ohio

tions were accomplished. The easiest locations for DX QSO are Caucasus, Leningrad region and Vladivostok, because they are located near the sea. In the middle of the country, the proposition is more difficult. In central Russia they have made some contacts with U.S.A., but east of Moscow I have not yet heard of one good contact. The best time for U.S.S.R.-U.S.A. QSO is 0000 to 0300 G.C.T.

"Eu08RA, Leningrad, had QSO with 8 NU stations. Ag67RA, Baku was QSO 17 NU stations, in one night. Eu09RA, 20RA and 05RA, at Moscow, have QSO'd several NU stations. Contacts with SB are good.

"On 30 meters there are many DX stations, and on the 20-meter band also, particularly in the day time.

"Tests have demonstrated that the best time for DX in European Russia is between 0200 in the evening, local time, until sunrise, although several NU stations have been heard on the 40-meter band at 1000 in the morning.

"An interesting experiment was carried out here recently. A short-wave set was installed in the basket of a balloon, working on 40 meters under the call xenCSKW, with 20RA as the operator. During a flight across country continuous QSO with stations on the earth was maintained, and the radio end was a complete success. As a result of this, public attention has turned to short-wave radio and amateurs get attention 24 hours in the day!

"The operator at 08RA now proposes to go up in a balloon herself (ah!—a Russian YL!—Ed.) and work a short-wave set.

—*W. Grzybowski, eu13RA*

STATIONS BELOW 50 METERS

(Continued from June QST)

- 24.9 NKF, Bellevue, Anacostia, D. C.
- 24.9 NAA, Arlington, Va.
- 25. PCMM, The Hague, Holland.
- 25. eg2YT, Poldhu, England.
- 25. POY, Nouen, Ger.
- 25. PCP, Cap. Polonio.
- 25. HZA, Saigon, Fr. Indo China.
- 25. PCR, Kootwijk, Holland.
- 25. FW, St. Assise, France.
- 25.3 5DH, Dollis Hill, P.O. England.
- 25.5 AGB, Nauen, Ger.
- 25.5 B82, Brussels, Belgium.
- 25.5 NKF, Bellevue, Anacostia, D.C.
- 25.728 VIZ, Melbourne, Aust.
- 25.906 GBH, Grimsby, Eng. (Beam)
- 26. AGA, Nauen, Ger.
- 26. AGC, Nauen, Ger.
- 26. FAMJ, SS Jean d' Arc.
- 26. ICJ, Bengazi, Cyrenaica, Libia.
- 26. VIS, Sydney, Aust.
- 26. VJS, Rabaul, New Guinea.
- 26. WNU, New Orleans, La.
- 26.086 GBK, Bodmin, Eng. (Beam)
- 26.2 ANC, Tjillin, Java.
- 26.269 CG, Montreal, Can.
- 26.3 AGB, Nauen, Ger.

Let us Send You This Book!

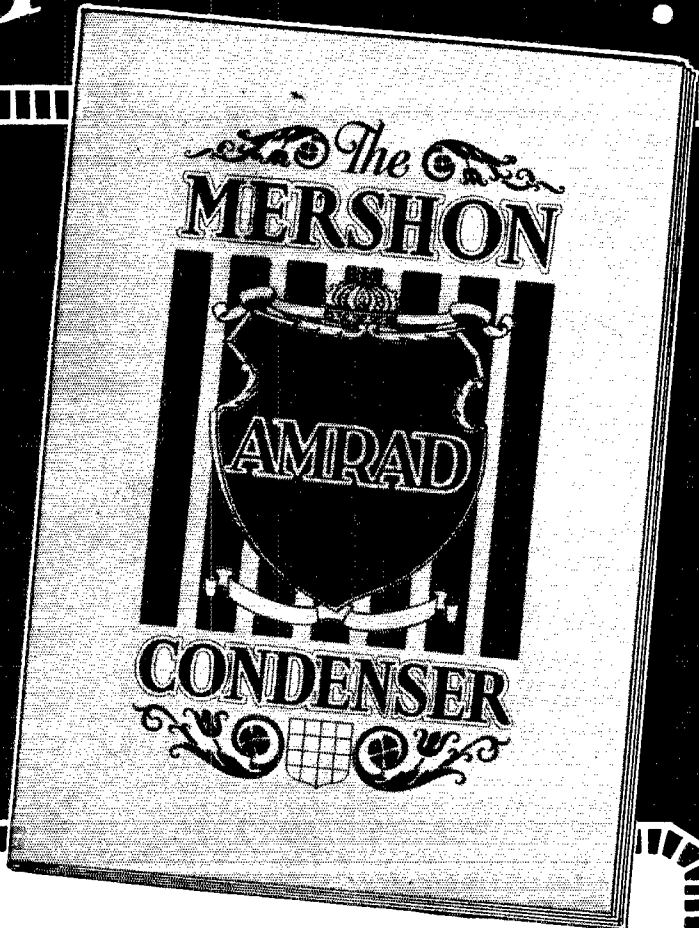

For "B" Eliminators, Power Supply and Filter Circuits, nothing compares to the Amrad Mershon Condenser, which is self-healing, absolutely unaffected by weather conditions, and has extremely high capacity in extremely small space.

Let us send our new book, showing hook-ups and explaining the many uses of Mershon. Address Department 28

The AMRAD Corporation
Medford Hillside, Mass.

J. E. HAHN,
President

POWEL CROSLY, JR.
Chairman of the Board

THE Great New VIBROPLEX

Reg. Trade Marks: Vibroplex-Bug-Lighting Bug

No. 6

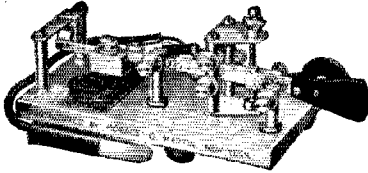

Japanned Base \$17
Nickel-Plated 19

Here's the Bug you want! Slow or fast — it sends smoothly, accurately and with amazing ease, 10 Great New Features New design.

More beautiful. More efficient. A great bug! Hundreds already sold.

Famous Improved Vibroplex

Used the world over because of its ease and perfection of sending. Over 100,000 users.

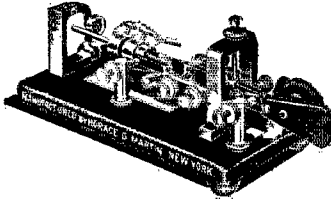

Special Radio Bug Japanned Base \$17
Equipped with extra large, specially constructed contact points to break high current without use of relay \$25
Nickel-Plated 19

Remit by Money Order or Registered Mail.

THE VIBROPLEX CO., Inc. NEW YORK
825 Broadway Cable Address: "VIBROPLEX" New York



Push-Pull Power Stage for Dynamic Speakers

For best results, every dynamic type speaker should be preceded by a push-pull amplifier. This is particularly true because they reproduce frequencies as low as 30 cycles and the attendant hum from raw AC on the filaments of power tubes is greatly pronounced unless filtered out by a push-pull amplifier. The AmerTran completely wired push-pull power stage has been specially designed for dynamic speakers. Consists of type 151 input and output transformers (200 for working out of 210 type tubes or 361 for 171 type tubes). Completely wired with sockets and resistances. Also available for cone type speakers and for both 210 and 171 tubes.

Licensed under Patents owned or controlled by R. C. A. and may be bought with tubes

Price complete (without tubes) \$36.00. (slightly higher west of Rocky Mountains)

Write us for look-up of this remarkable instrument.

AMERICAN TRANSFORMER COMPANY

Transformer Builders for more than 28 Years

192 Emmet Street, Newark, N. J.

- 26.3 KDKA, East Pittsburgh, Pa.
- 26.3 WDJ, Harrison, Ohio.
- 26.8 8XK, East Pittsburgh, Pa.
- 26.92 2XAG, New York City.
- 27. AGB, Nauen, Ger.
- 27. ANH, Malabar, Java.
- 27. PCPP, Kootwijk, Holland.
- 27. PKX, Java.
- 27. RCRL, Central Lab., Leningrad, U. S. S. R.
- 27.5 KKC, Palo Alto, Calif.
- 27.5 PCMM, Kootwijk, Holland.
- 27.6 5DH, Dollis Hill, Eng.
- 27.9 WKC, Newark, N. J.
- 27.9 WKI, Newark, N. J.
- 28. FUL, Beyrouth-Djedeide, Lebanon.
- 28. KNN, Honolulu, T.H.
- 28. POW, Nauen, Ger.
- 28.15 KWE-KEWE, Bolinas, Calif.
- 28.26 WQA-WEQA, Rocky Point.
- 28.4 SPW, Rio de Janeiro.
- 28.5 2ME, Sydney, Aust.
- 28.5 RDRL, Leningrad, U.S.S.R.
- 28.58 KMM-KEMN, Bolinas, Calif.
- 28.8 AND, Tjililin, Java.
- 28.8 KSS-KESS, Bolinas, Calif.
- 28.8 PCH, Scheveningen Port.
- 29. JPS, Sapporo, Japan.
- 29. NKL, Arlington, Va.
- 29. OCNG, Nogent-le-Rotrou
- 29.226 PCH, Scheveningen Port
- 29.282 PCH, Scheveningen Port
- 29.3 6XI, Bolinas, Calif.
- 29.3 KEL, Bolinas, Calif.
- 29.3 SPW, Rio de Janeiro.
- 29.5 KNR, Clearwater, Calif.
- 29.5 PCTT, Kootwijk, Holland.
- 29.71 WQX-WEQX, Rocky Point.
- 29.8 3LO, Melbourne, Aust.
- 29.83 WQY-WEQY, Rocky Point.

(To be continued in Aug. QST)

Calls Heard

(Continued from Page 61)

1kh 1mr 1my 1nv 1nf 1od 1oj 1pe 1qy 1rd 1rf 1ry
1sw 1ue 1vc 1zl 2aby 2afv 2afx 2ahg 2akl 2aks 2aog
2api 2asb 2ayb 2avz 2aue 2baa 2bac 2bad 2bef 2bev
2bfq 2bge 2bet 2bg 2bha 2bum 2bhq 2bir 2ek 2emu
2evj 2dp 2gp 2jc 2jn 2ka 2md 2nm 2ol 2ox 2qu 2tp
2va 3adm 3aib 3ank 3bgs 3bjm 3bta 3cee 3cig 3ekj
3hf 3sh 3wm 4adh 4bl 4ea 4io 4jm 4pd 4rn 5afb 5yb
5adm 5adg 5ahe 5ail 5ahk 5ake 5aly 5amu 5aul 5avs
5axa 5ayu 5bcu 5bde 5ben 5bhz 5box 5brt 5clt 5che
5ejm 5eke 5enh 5enj 5epr 5evj 5eug 5ddn 5dhp 5dgp
5dhx 5djv 5dll 5drj 5dsa 5dsi 5hx 5iq 5as 5baf 5eln
ne-lad ne-lam ne-lap ne-2al ne-2an ne-2ax ne-2be
ne-3bt ne-3es ne-3qs fo-a3z fo-a4e fo-a4f fo-a4x fo-a5x
fo-a7n fo-a9a wnp au-luc ai-2kt.

eg-2HJ, K. E. Brian Jay, 19 Elm Close, Amersham, Bucks, England (20 Meters)

1aa 1ahi 1afb 1alb 1anh 1aqd 1bqd 1eki 1emd 1li
1ql 1uo 1wv 2aae 2acm 2auo 2bec 2bfq 2hq 2ox 2vn
2ahr 2ajh 2anh 2aok 2bjm 2hf 2ku 2nz 2qv 2qw 2sh
2es 2jm 2sk 2tk 2aul 2ael 2aot 2at 2bj 2ns 2rg 2af
2ajj 2fe 2afa 2agy 2alu 2arc 2asb 2atv 2bcu 2bou
2bpx 2brh 2cpr 2dew 2dne 2dsa 2re 2sm 2alv 2ama
2bvh 2bhv 2cfn 2cyl 2oak 2euh 2uou 2dsz 2dxi 2ege
2ehd 2ehs 2elj 2ekt 2ez 2fy 2gw ne-1by ne-1co ne-2be

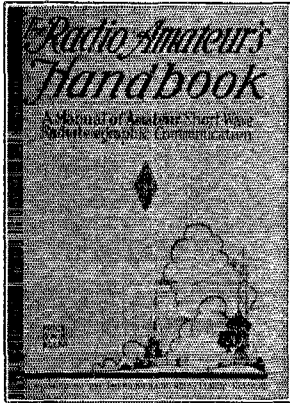

Special Offer



and the

Radio Amateur's Handbook

for \$3.00

During JULY and AUGUST Only

The Radio Amateur's Handbook is the most important piece of equipment in any station! Without it, a station is probably inefficient. With it, a station becomes known for a good 'punch', good operating methods, proper wavelengths and a sharp, non-interfering note. The Radio Amateur's Handbook paints the whole picture of the greatest of modern hobbies, covering everything from so elementary a start as the explanation of what amateur radio is, and how to become an amateur, up to the details of construction and operation of the most up-to-date type of amateur transmitter, and the most elusive and complex of traffic-handling procedures. Data and complete constructional information on the building of many pieces of apparatus are given.

Special Offer

ON THE HANDBOOK, a year's subscription to *QST* and a year's membership in the A. R. R. L.

All for \$3.00

Even if you are already a member of the League and a subscriber to *QST*, you may avail yourself of this offer. Simply mention that fact and instead of entering it as a new subscription we will extend your present subscription for another year, and send a copy of the Handbook at once.

American Radio Relay League

1711 Park Street

Hartford, Connecticut

American Radio Relay League,
Hartford, Conn.

Dear Sirs:

I want to take advantage of your Special Offer and enclose three dollars.

I am
am not a member of the League.

.....
.....
.....

nc-3bc nc-3es nc-3gg nc-5cp np-4ja oa-5dx oa-3dc sb-1lb sb-2aj sb-2ar su-1am.

(40 Meters)

1acj laqi laqo ibat ibbn ibeb lbgf lpcp lfp lmk
1wr 1ws 2aes 2ari 2bes 2bfn 2bkg 2bhi 2bhw 2bke
2bkf 2blr 2blx 2bmb 2bms 2bnn 2bd 2qs 2rk 3afu
3alf 3amx 3aqi 3ard 3bhp 3cix 3di 3dj 3er 3fh 3ga
3gg 3in 3na 3ul 3si 4aam 4aba 4abw 4acc 4acy 4ada
4aep 4amd 4dt 4fx 4gl 4ib 4io 4nn 4oo 4pk 4px 4tg
4wm 4wx 5aej 5afx 5agu 5amo 5aoc 5aq 5auj 5auy
5ary 5di 5ew 5gr 5jc 5kg 5oc 5rg 5zav 6bsn 6ta 6vz
7fe 8ap 8apn 8ay 8ayo 8azg 8baf 8bax 8bp 8buj
8cal 8ace 8ecw 8cla 8ens 8cxg 8ccz 8dem
8drg 8kg 8or 8ua 8uj 8aas 8ac 8azf 8ahk 8anh
8ahz 8arn 8avp 8bge 8bkl 8bqc 8bs 8bxo 8cfs 8cmv
8exz 9e1ya 9dex 9dft 9dms 9drs 9ds 9dwa 9dxz 9eca
9efo 9ell 9erh 9etd 9gt 9ll as-1lra nc-3bm nc-3uv
nn-2nic no-5fl sa-bx2 sa-df4 sa-dw4 sa-ea8 sa-ens
sb-1ah sb-law sb-lay sb-lbr sb-1ca sb-1cm sb-1dc
sb-1dx sb-1ld sb-2ah sb-2ax sb-2ay sb-2az sc-7aa
su-2bt oa-3bq oa-3dc oa-3vp oa-3xo oa-5hg oa-7jk
oz-2ae oz-3ar oz-3au oz-3az oz-4am.

eg-BRS93, G. Hoodage, 1 Friston St., Fulham, London, S.W. 6, England

(Heard on April 15 on 20 meters)

1zl lawe lbke lbat lcfm lqe lcpb lcmx Ebac 2ox
3ku 3qa 4bq 4cb 8btf 8chr 8ces 8btf 8bec 9cau nc-1am
nc-1do.

(40 meters)

lara lahx laug lahn ladb laue lace laef lakk
ladi laus lab lbnn lbgc lbke lfcf lcong lfq lfd lide
lid lim lom loo lno legz lrp lnic lrn lvt lvae 2ge
2bg 2bit 2bec 2exl 2cgg 2acd 2af 2aw 2mt 2as 2kp
2bey 2vm 2bum 2bex 2bjj 2bfn 2aun 2fd 2vo 2tp
2bhr 2bm 2age 2bay 2bf 2tt 2auo 2are 2ajg 2ct
2bgb 2ats 2aot 2ahh 2ajc 2di 2bis 2bac 3bq 3ard 3pf
3ark 3lz 3ath 3pg 3bbh 3aaz 3bns 3afx 3gi 4uf 4uq
4aar 4aab 4aac 4uae 4ufe 4nkf 4lx 4fx 4pt 4ae 4qz
4gl 4ky 4bb 4uf 4ra 4aba 4it 5ayl 5fl 5yb 5aue 5ax
5ain 5btk 8atv 8lf 8enz 8ens 8fkz 8ezd 8deg 8ese
8exi 8adm 8dvt 8oq 8awu 8bbs 8hou 8ent 8ctl 8cal
8aij 8aph 8ami 8chp 9dkg 9fks 9aid 9dft 9fp 9cmm
9ad 9bz 9su 9evn 9eve 9rf 9mq nc-1bh.

eg-6YL, Miss B. Dunn, Stock, Essex, England

(Heard during April on 40 meters)

1amu 1aru 1asy lom 2abz 2aaj 2blx 2bms 2exl
3bsd 3ly 3na 4gl 4nm 5yb 8buj 8cqn 8dbi 8uj 9arn
9eph 9dik 9ege 9ell em-smuv em-smwg xem-sfv
eu-ra9l eu-08ra eu-15ra eu-57ra fm-8ssr nc-2ca
nq-6cx.

et-TPAR, J. Ziembecki, Lwow, Biclowskie, 6, Poland

1aba 1adm 1age 1akm 1amv 1app 1bea 1beb 1bhs
1bke 1bop 1bqs 1bqt 1cjc 1cmp 1cnz 1ga 1gw 1si
1sg 2afv 2atq 2ayj 2bnc 2bcb 2bdh 2car 2cox 2cl
2kx 2ov 2rs 2um 2xaf 3ado 3aih 3akv 3bph 3bwt
3crg 3ckj 3pf 3ql 4aev 4ob 4vae 8acr 8bhx 8bke 8cnh
8cxz 8drj 8rh 9tq ac-2ff ag-raun ag-67ra ai-1bb
ai-2bg ai-2kt ai-2kw ai-2kx ai-qbd ai-1hf ai-1lm
aq-1mdz as-osa as-1lra ea-grp ea-fk ea-l ea-lpo ea-
py ea-ra ep-o ea-tp ea-tx ea-wf ea-wu ea-pl eb-r8
eb-4ar eb-4as eb-4au eb-4bc eb-4bt eb-4bu eb-4cb
eb-4cc eb-4cm eb-4co eb-4cd eb-4fo eb-4el eb-4w
eb-4ft ef-4hp eb-4ic eb-4k eb-4fo eb-4tm eb-4vr
ee-1ab ee-1kx ee-1rf ee-1uz ee-aa2 ed-7bb ed-7bl ed-7cc
ed-7du ed-7hj ed-7hm ed-7jo ed-7lo ed-7na ed-7ob
ed-7rl ed-7zgn ee-ak1 ee-ak2 ee-ar28 ee-ar38 ee-ar55
ee-ar62 ee-ar73 ee-ar74 ef-fw2 ef-fnd ef-fnd2 ef-8ba
ef-8bf ef-8bl ef-8bp ef-8br ef-8cc ef-8cp ef-8amf
ef-8co ef-8est ef-8eu ef-8fd ef-8fk ef-8gdb ef-8gou
ef-8grg ef-8gyd ef-8hco ef-8ho ef-8ix ef-8jc ef-8jd
ef-8kk ef-8kv ef-8lap ef-8lb ef-8lj ef-8lt ef-8lx ef-8lz2
ef-8mb3 ef-8mcy ef-8mpm ef-8mp ef-8mop ef-8msm ef-8oop
ef-8orm ef-8pac ef-8pcx ef-8pjm ef-8pl ef-8pme
ef-8rac ef-8rac ef-8rhj ef-8rit ef-8rnf ef-8rpu ef-8rv
ef-8rw ef-8sac ef-8ses ef-8ssw ef-8sy ef-8tis ef-8tkr
ef-8toy ef-8taf ef-8udi ef-8vvd ef-8wf ef-8xo ef-8ynb
ef-8ypm ef-8zb ef-8zed ef-8zod ef-18gr ef-2ah 2g2-av
2g-2ay 2g-2bq 2g-2dl 2g-2hj eg-2pp eg-2rg eg-2sc
eg-2un eg-5by eg-5dh eg-5j eg-5jw eg-5kz eg-5lf
eg-5lu eg-5ml eg-5ph eg-5rq eg-5sq eg-5sk eg-5uw eg-5uy
eg-5wp eg-5wq eg-5xd eg-5yx eg-6bw eg-6dh eg-6hp
eg-6ig eg-6lb eg-6nf eg-6no eg-6pp eg-6ub eg-6rb
eg-6tx eg-6uo eg-6uz eg-6vj eg-6wo eg-6wy eg-6yl
eg-6yq eg-6vy eg-6zr ge-5vg gi-5wd gi-6mu gi-6wg
gi-6yq gi-6yq gi-8m qk-9xf ei-1am ei-lax ei-lay ei-lce
ei-1dr ei-1dy ei-1eh ei-1fb ei-1gc ei-1gl ei-1lj ei-1mg
ei-1rk ei-1rv ek-hll ek-4au ek-4el ek-4dha ek-4dk
ek-4dka ek-4fn ek-4fd ek-4gd ek-4hl ek-4hy ek-4ku ek-4ls
ek-4nd ek-4nv ek-4nx ek-4ga ek-4gm ek-4uak ek-4uf

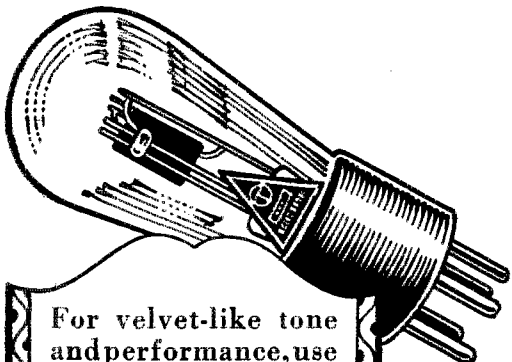

For velvet-like tone and performance, use Televocal Quality Tubes. All standard types. Ask for them at your dealers.

TELEVOCAL CORPORATION

Televocal Building
Dept. R-1, 588 12th Street
West New York, N. J.

Televocal
Quality Tubes

Consider First
The
Volume Control

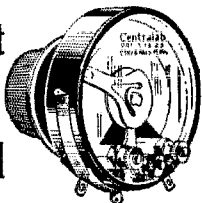

The volume control of a radio set is one of the parts most used and subjected to the most wear. Care must be taken to choose the type that will give the longest trouble-free service—a type that will not introduce noise to interfere with the quality of reception after a short period of service.

Centralab Volume Controls have a patented rocking disc contact that eliminates all wear on the resistance material. This feature adds to the smoothness of operation because a spring pressure arm rides smoothly on the disc and NOT on the resistance. The pushing and shaft are thoroughly insulated from the current carrying parts. This simplifies mounting on metal panel or sub base and eliminates any hand capacity when the volume control is in a critical circuit. Full variation of resistance is obtained in a SINGLE TURN of the knob.

Plus these exclusive features, Centralab has carefully studied every volume control circuit and has built-up tapers of resistance to fit each application. These taper resistances are an assurance of a control that operates smoothly and gradually vary the volume from a whisper to maximum—no sudden cut-offs on distant signals—no powerful locals creeping through when control is set at zero.

These resistances are known as Centralab Radiohms, with two terminals; Potentiometers, with three terminals, and Modulators with three terminals and especially tapered for audio control. The specific circuit, in which each of these units are used, is outlined in a folder. You may have it by writing.

CENTRALAB RADIO LABORATORIES

20 Keefe Ave. Milwaukee, Wis.

Centralab

Are you suitably equipped for TEN METERS?

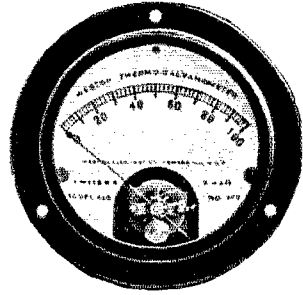

The Weston Model 425 Radiation Ammeter will give you the exact amount of current supplied to the antenna at the wave length of 10 meters (or 30 megacycles) now being advocated. It is generally known that when a wave length is shortened the frequency increases. The effects are that greater distance can be obtained with less power and with an ultimate reduction in equipment. But as the frequency increases a point is reached where the ordinary instrument becomes entirely unreliable owing to the frequency errors of such designs for which no compensation is possible.

The Weston Model 425 Radiation Ammeter is superior to all other instruments for this service. Not only are its constructional features typical of highest Weston quality but it possesses the essential electrical characteristic that its readings are accurate on any wave length—entirely unaffected by frequency errors which are invariably found in inferior instruments.

Weston Electrical Instrument Corporation
602 Frelinghuysen Avenue, Newark, N. J.

Another instrument made in the same size— $3\frac{1}{4}$ " diameter—and exactly the same in appearance is the Model 301 Voltmeter with bakelite case for reading the filament voltage of the transmitting tube. Supplied in 8 volt or 15 volt ranges. Also the same model for measuring the plate voltage and the plate current supply.

Prices—Complete, Ready for Panel Mounting

Model 425, $3\frac{1}{4}$ " diameter, from \$13.50 to \$15.00

Model 301, $3\frac{1}{4}$ " diameter, \$8.00

WESTON RADIO INSTRUMENTS

It's Worth Sending For!

A handy manual—36 pages and cover—88 illustrations and over 20,000 words of practical, concise, fool-proof text—prepared by Austin C. Lescarboura in collaboration with our engineering staff. Usable. Unselfish. Unbiased. Just the plain and workable radio truth. You can use a copy! So can that chap who pesters you for radio dope!

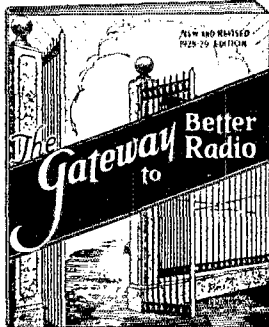

Ask your radio dealer for a copy, or send 25 cents in stamps or coin direct to us, and we'll send the manual as well as other Clarostat literature.

American Mechanical Laboratories, Inc.

Specialists
in Variable
Resistors



285-7
North Sixth St.
Brooklyn, N. Y.

CLAROSTAT

REG. U.S. PAT. OFF.

BUILD A DAVEN TELEVISION RECEIVER

Complete Essential Kit, \$45.00

The first complete Kit enabling anyone to build his own television receiver—and sponsored by Daven! The Kit consists of a Daven 24 aperture scanning disk for receiving WGY, Daven Motor, Bushing, Daven Television Tube, Three complete stages of Daven Television Amplification and Instructions for Building.

Daven 2 Stage Power Essential Kit \$10.00

For use with 210 tubes—2 stages of Daven Power Television Amplification complete with Daven Super Davonoms and Instructions for Building.

Daven Television Apparatus

Daven Television Scanning Disc— 24 apertures for WGY	\$ 5.00 each
Daven Television Scanning Disc— 36 apertures for WRNY	6.00 each
Daven Television Scanning Disc— 48 apertures	7.00 each
Daven Special Television Amplifier (3-T)	(2.50 each
Daven Television Tubes—20 to 80 milliamperes striking voltage 150, Plate $1\frac{1}{2} \times 1\frac{1}{2}$ inches	12.50 each
Daven Television Motor	15.00 each
Daven Bushing to fit $\frac{1}{4}$, $\frac{5}{16}$ and $\frac{3}{8}$ " motor shafts	1.00 each
Daven Television Photo Electric Cell	25.00 each
Daven Television Resisto-Couplers for stages 1, 2 and 3	2.15 each
For stages 4 and 5	4.85 each
Daven MU-20 Tubes for Amplifier Stages	2.25 each
Daven AC-71 Tubes for output tube in series with Television Lamp	3.50 each
Daven AC-10 Tubes for output tube in series with Television Lamp	9.00 each

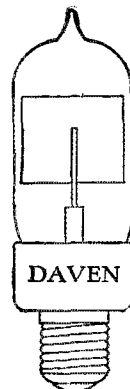

Write For Television Booklet

The Daven Corporation Amplification Specialists Newark, N. J.

Ad. Auriema, Inc.
 Manufacturers' Export Managers
 118 Broad Street, New York, N.Y.

Scientifically equipped to economically export dependably receiving and transmitting radio apparatus

CLAROSTAT
 BRACH
 FARRAND
 SANDER
 SPARKER
 DUBILLET
 "LSCO"
 BREDE

ek-4uj ek-4vb ek-4vj ek-4xr ei-lala ei-laly ei-lalw
 el-lalx em-smga em-smrv em-smss em-smtc em-smto
 em-smua em-smuk em-smus em-smuy em-smye
 em-smzf em-smzy xem-sfv en-0cp en-0dj en-0ec
 en-0gm en-0ly en-0mar en-0vn en-0wg en-0ze en-0zf
 eo-1ld eo-1iz eo-14b eo-17c ep-1aa ep-1ag ep-1ai ep-1bd
 ep-1bk ep-1bl ep-1bx xep-1ma ex-5af es-1co es-2bb
 es-2nad es-2nc es-2nm et-tpach et-tpbg et-tpbi
 et-tpbp et-tpej et-tpim et-tpju et-tpm et-tpmn
 et-tpzo et-tpzz et-p2rn eu-pag eu-nno eu-rk46 eu-lwa
 eu-3wk eu-4ra eu-084a eu-09ra eu-12ra eu-13ra eu-15ra
 eu-23ra eu-39ra eu-waa ew-ab ew-ah ew-if
 ew-km ew-h2 ey-1co ex-lag fb-8hl fe-egex fe-lac
 fe-les fi-lta fm-al fm-8ags fm-8mb fm-8psrv fm-8st
 fm-8sr fm-8v nc-lar nc-lbr nc-lda nl-gren np-4pq
 nq-6cx nt-2ai op-1dr oz-lan oz-2aq oz-2gg oz-3me
 oz-2xa oz-4ae sb-lah sb-lak sb-1ao sb-laq sb-law
 sb-1br sb-1ca sb-1cm sb-1ic sb-2ar sb-2as sb-2ax
 sb-2id sb-2nm se-lah se-3bd su-1oa.

en-R030, C. C. Verbeek, Room 413, H.T.O., Laakkade 30, The Hague, Holland

(Heard between Feb. 12 and April 13)

labz ladm laff lafz lahx lair lakd lakm lakz
 lair lamq laqt larv lasr latj latv lavj lazd lbqx
 lbkp lbqt lbr lejc lerm lenp lesx letp ldl ldp lq
 lf lf lf lgh lgw lide lmo lom lpi lsz lvp lwl 2abp
 2acd 2aem 2afb 2afo 2ajt 2aol 2aoo 2ass 2atk 2atq
 2aub 2aur 2avb 2avm 2ayj 2az 2bhd 2bfn 2bjs 2bj
 2bst 2ct 2erb 2euc 2dg 2gp 2lx 2qh 2qt 2rs 2sj
 2tp 2ty 2zy 2zj 2ze 3acu 3aev 3ahh 3anh 3ani 3auv
 3bed 3blp 3bns 3bg 3bd 3bp 3cbt 3cd 3ev 3oc
 3pf 3qp 3si 3sz 3az 3cf 4ei 4kc 4qy 4tk 4wk 5eb
 6xi 6adg 6agi 6ako 6alu 6ath 6avp 6ayu 6bhz 6bmn
 6box 6cau 6cc 6cew 6ent 6etl 6dh 6dei 6djp 6dpo
 9am 9aj 9bh 9ciw 9cos 9cut 9ef 9fs 9m nc-lam nc-lar
 nc-lbr nc-lda nc-2bv nc-3ay nq-2jt nr-2ags nx-1xl
 fq-pm oh-5hg sa-de3 sb-lar sb-1ld sb-2ad sb-2ag
 sb-2ah sb-2ax sb-2az sb-5az xed-oij.

ec-2UN, Radio Club Ceskoslovensky, Prague II, Slovansky ostrov, Czechoslovakia

lajz lavu lawe lcom lepj lgh lzz 2aib 2al 2alp
 2bif 2bev 2gp 3bkl 3rsy 4es 6oa 7lr 9dxx 9ed ac-lcl
 ac-2al ac-2ek ac-2ff aj-lsk aj-2by ik-3ms oa-2sh
 oa-3ag oa-3xo oa-5bw oz-2hf oz-3az nc-lad nc-2by
 nj-2pa ns-1fmb sb-lah sb-lbi sb-law sb-lib sb-lid
 sb-2ah sb-2az sb-3qa su-1oa.

ef-8PY, c/o R.E.F., Paris, France

laaw labv laed laru lata lbqt lcpf lgh lgv lgw
 lmr lou lry lyc lvw 2agu 2alp 2ama 2aol 2anh
 2atq 2bdf 2bgz 2bir 2bkl 2akz 2agv 2ap 2ar 2as
 2avb 2avz 2aws 2ays 2bbx 2bj 2bc 2bsa 2bei 2bxx
 2ctp 2nm 2tp 2uh 2va 2vi 3apx 3am 3arq 2ke 2lv
 2qw 4act 4bl 4ft 4lp 5af 5bj 5kg 5adg 5adm 5agq
 5ags 5aul 5axa 5baf 5bmd 5btj 5cag 5cim 5cmb 5cnc
 5cuz 5evj 5dne 5dx 5hm 5ncj 5avp 5btw 5bvh 5ce
 9ef 9ez 9evy 9dzz 9esk 9pm 9x nc-lar nc-2al nc-3bt
 nc-3es nc-3us nc-4fv nc-7ag nc-8ae fo-4ae sb-lib
 sb-2as aq-1lm af-lb shm wnp.

R. Dezerville, 46, Rue St. Laurent, Lagny Set M. France (20 meters)

laba labf labd lage labi lakd laot laqt lasf lawe
 laxa lazd lbat lbay lbiv lbus lbvt lbw lcmd lcxm
 lfs lgp lij lia ljj lka lmr lmx lny lrd luo liw
 lzac 2ad 2afx 2akl 2akz 2agv 2ap 2ar 2as 2avb
 2avz 2aws 2ays 2bbx 2bj 2bc 2bsa 2bei 2bxx
 2ctp 2nm 2tp 2uh 2va 2vi 3apx 3am 3arq 2ke 2lv
 2qw 4act 4bl 4ft 4lp 5af 5bj 5kg 5adg 5adm 5agq
 5ags 5aul 5axa 5baf 5bmd 5btj 5cag 5cim 5cmb 5cnc
 5cuz 5evj 5dne 5dx 5hm 5ncj 5avp 5btw 5bvh 5ce
 9ef 9ez 9evy 9dzz 9esk 9pm 9x nc-lar nc-2al nc-3bt
 nc-3es nc-3us nc-4fv nc-7ag nc-8ae fo-4ae sb-lib
 sb-2as aq-1lm af-lb shm wnp.

ef-R091, C. Conte, 24, Allée du Rocher, Clich-sous-Bois, (S-et-O) France

labt lagi laha laip lafo lauj lavj laxq lbbn
 lcx lcd lced lchr lejc lezm lia lii lmx lom lry lvs
 lvw lzo lab 2afa 2ags 2aju 2aov 2apd 2atk 2avw
 2aid 2bda 2bhd 2bfn 2bgr 2bgg 2bhr 2bf 2bj 2bcj
 2bci 2enn 2euj 2evj 2exl 2fs 2ge 2gh 2rs 2wc 2cy
 2afx 2adv 2aqs 2aqw 2aqz 2au 2atl 3bel 3es 3gd
 3na 3nd 3pf 3ra 3aba 4abz 4ada 4aeb 4aee 4af 4es
 4ll 4lx 4nf 4qz 4rf 4rn 4ut 3wo 4aee 5aay 5aej 5amo
 5axn 5aq 5jc 5oa 5yb 6bjf 6jin 7kf 8adm 8ame 8ajt
 8akt 8apd 8avd 8avw 8axg 8ayu 8bbl 8bbs 8bjl 8box
 8bcu 8chi 8cnp 8ciw 8ela 8elp 8ear 8eqn 8erp 8eto
 8euk 8dij 8dpo 8dsv 8gk 8li 8sp 8vx 8qh 9adl 9aid
 9avp 9bmm 9erd 9erj 9esj 9ezd 9dk 9dra 9drs 9edv
 9ees 9ezc 9etd 9eyu 9ez 9fap 9fs 9lc 9uu nq-6cx
 np-4ja nc-lad nc-2br nc-2be nc-2ca nc-2al nc-3es
 nc-3ls wsq.

TOBE Dynamic Speaker Energizer

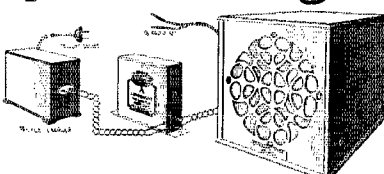

Any trickle charger capable of delivering 1/10 of an ampere with this TOBE-A-CONDENSER 4000 Mfd. connected as shown, will furnish the proper power to energize your Dynamic Cone Speaker.

TOBE-A-Condensers List Price \$6.00
 Write for Pamphlet of this new A-Condenser and A-Filter.

TOBE DEUTSCHMANN CO.
 CAMBRIDGE, MASSACHUSETTS

TRANSFORMERS
 Guaranteed—Mounted—Complete

250 watt 550—700 each side	\$10.50
700 watt 1000—1500 each side	14.50
700 watt 2000—2500 each side	21.00
1 Kw 2000—2500 each side	30.00

Add \$2.00 for fil. winding

SCES F. GREBEN
 1927 So. Peoria Street, Pilsen Sta., Chicago, Illinois

GREAT LOSS OF LIFE FEARED AT MONTPELIER

Denton, Nev. 5.—(AP)—New
Belgias were reached today in
the ever mounting toll of life
and property lost in the worst
storm and flood disaster that
New England has experienced
within memory, and although

Overshadowing everything else in
the storm stricken area was the
message of H. A. Kelly whose wife
and son died in the neighboring city of
Denton, one of whom was reported to
be the lieutenant-governor of the
State, & H. Jackson.
The message was sent out by Sta-
tion 127E and was picked up by
Arthur E. Koeb, an amateur operator
at Binghamton, N. Y. who relayed it
—The Associated Press.



Binghamton, N.Y. April 9, 1928

On the night of Nov 4, 1927 I
was the only person in the room in touch
with the flooded city of Montpelier and for 24
hours without a sleep my little Esco generator
kept the Associated Press, United Press and
N.Y. Government in touch with F. J. Heff (Associated Press
Correspondent at Montpelier) and my reception & reports
from 127E Denton sent to all corners of the globe.

8370

Your trust A. L. Heist
199 Court St

ELECTRIC SPECIALTY COMPANY

TRADE "ESCO" MARK

South Street

Stamford, Conn.

Real DX means maximum miles per watt, and that is what ESCO" generators are built for

A. R. R. L. Members -- What about your friends?

You must have a friend or two who ought to be members of our A.R.R.L., but aren't. Will you give us their names, so that we may write to them and tell them about the League and bring them in with the rest of us? The A.R.R.L. needs every eligible radio enthusiast within its ranks, and you will be doing your part to help bring this about by recommending some friends to us. Many thanks.

American Radio Relay League,1928
Hartford, Conn.

I wish to propose

Mr. of

Mr. of
Street & No. Place State

for membership in the A.R.R.L. I believe they would make good members. Please
tell them the story.

.....
.....



SEE THE NEW

Balkite Radio

a radio set worthy of
one of the greatest
names in radio

IN CABINETS BY

Berkey & Gay

SEE IT AT THE DEALERS TODAY

FANSTEEL PRODUCTS COMPANY, INC.
NORTH CHICAGO, ILLINOIS

B. Brenner, Fredriksq 16, Helsingfors, Finland
lcm lmk lmy lll lim lxxv lxw lacg laef lasy lasy
lbkc lcaa lccx lcfp lhmh 2ay 2cx 2fs 2jc 2md 2ow
2rs 2ay 2up 2afz 2atg 2abx 2alu 2alu 2baj 2bac 2bhd
2bgh 2bhr 2bif 2bvg 2bkk 2ami 2bcl 2bmc 2bnu 2ei
2ft 2sv 2acz 2adm 2jw 2afx 2ed 2dia 2vg 2bth 2fs
2bge 2nox aq-rann aj-2bg aj-2kt aj-2kx aj-2rxp ar-
arax aq-lm aq-lmdz fm-8kr fm-8prv fm-fmal fi-lta
fo-a9a fg-8cag fe-fes fe-geez fq-pm oa-2bb oa-2dy
oa-4dy oa-5hg oa-6sa oa-7cw oz-3aj oz-3az na-9efo
meya oeyu.

ed-7GB, G. Brammer, 132 Osterbrogade, Copenhagen,
Denmark

(Heard in April on 20 and 30 meters)

lade ladm lack laff lakd lakz labl lanz lasy
lawe lejh lei lij lpd lqh lvw 2bir 2bse 2cnm 2dr
2gp 2mt 2ox 2tt 2aom 2bjm 2adg 2dro 2mq 2etd
nc-lad nc-2be nc-3ap nc-8gg nr-2ags sb-1ah sb-1br
sb-1dx sz-2af sb-2ax sb-2az sc-3ac sc-3ej su-loa sa-
rao8 ne-8rg.

A. G. Brown, 8 Mangarra Road, Canterbury E. 7,
Victoria, Australia

lags lamt lasf lasu lje lyb 2alu 2bra 3kt 3iw
4ai 4ll 4pd 4rt 5aav 5ard 5kg 5nw 5wm 6aah 6aai
6aap 6aaz 6aiw 6ajq 6al 6aiw 6alz 6amm 6anu 6asy
6ay 6baj 6bau 6bdj 6bfp 6bgn 6bhm 6bih 6bm 6bow
6bzu 6cby 6cct 6cdd 6cge 6cjj 6cjm 6cm 6csl
6cu 6cwl 6czl 6czx 6dat 6dev 6dez 6ddy 6dfm 6dfo
6dfq 6dfa 6dhr 6dho 6dij 6djj 6dkx 6dmk 6ec 6ek
6gk 6ij 6na 6tj 6ue 6xa 7afz 7vf 7adg 7scj 8dkx 8gz
8ase 8bez 8cht 9cjh 9cm 9erj 9erj 9erj 9erj 9erp
9eri 9erm 9ir 9uu 9xi xnu-6bzw nc-4du sb-lai oh-
6dju oh-6dtg oh-6dvz od-pkl op-lac op-lad op-lcw
ae-1bk ae-1hh aj-1mo aj-3in aj-4zz am-3ab eb-4ft
eg-5hd eg-6yb fo-3za.

G. A. Parslow, 27 Eastbourne Rd., Tooting Junction,
London S. W. 14, England

laev lad lahv lahx laje lajg lakm lai lani lany
lapc lary lauv lavy lawm lvi lbjg lbnm lcio lcje
lciz lckp lctf lim ikh ino loaf lom lrf lrp 2ags
2ama 2azo 2ate 2atg 2bcb 2bda 2bhd 2bds 2bhh
2bfn 2bfg 2bic 2bjs 2box 2evj 2evx 2cxl 2dx 2fd 2fg
2ja 2kr 2mb 2na 2og 2ra 2sm 2su 2tt 2vn 2ty 2bz
3ada 3adf 3ajd 3anh 3az 3aph 3arz 3bvy 3cb 3cf
3ch 3pf 3pg 3sg 3zpr 4ad 4ea 4ll 4ob 4pc 4pk 4rf 4sq
5kg 5az 5aju 5an 5avo 5dcm 5eqk 5no 5pl 5ejw 5elp
5emq 5er 5erz 5epu 5hl.

F. Pemberton, 115 Cambridge Road, Wimbledon,
London S.W. 20, England

latt lave lakm lawm laxa lbux lcmx lgw lho
llu lqv 2afa 2afz 2aji 2ama 2ang 2apw 2arm
2asa 2atq 2aub 2bad 2bdj 2ber 2bhv 2bpb 2bvh 2cle
2cty 2fs 2kc 2ot 2tp 2aq 2an 2anh 2ar 2eb 2af
4oo 4rr 4tg 5abz 5aci 5aej 5afb 5ahm 5amn 5amo
5amd 5aqe 5atf 5ayb 5bam 5bj 5dl 5fu 5he 5hz 5ja
5je 5kg 5nj 5oc 5qk 5sj 5tx 5uk 5uw 5wt 5ax 5am
5app 5azy 5bpl 5bjl 5bvy 5bzf 5bnz 5chl 5czz 5deq
5dev 5dfq 5djj 5dkx 5ue 7afz 7ail 7ajh 7alk 7bb
7bd 7cq 7ef 7ek 7ip 7mo 7mx 7no 8bbs 8bhz 8cfl
8civ 8dme 9aas 9adq 9agw 9ahj 9ahq 9ahz 9ajk
9aof 9aok 9arh 9arn 9aue 9axz 9bbw 9be 9blu 9bnf
9bod 9bp 9br 9bc 9bge 9bre 9bsh 9bwn 9bwo 9caf
9edi 9cej 9efg 9efm 9efw 9egt 9eia 9eji 9ejw 9cmv
9eph 9erd 9est 9ewn 9eye 9eys 9dce 9des 9dex
9dga 9dge 9dk 9dkc 9dng 9dnn 9doe 9dra 9ds 9dso
9dsz 9dxi 9dyl 9ebm 9ecz 9eey 9ef 9ebh 9ehn 9elh
9eld 9elix 9ems 9emp 9eob 9eoo 9eok 9eya 9eve 9evr
9exc 9eyu 9ez 9fao 9df 9ff 9fhy 9fs 9hl 9io 9mh
9nr 9rt 9su 9sw 9tq 9xi ae-1hh ai-2kw am-lab aq-
ldh as-ber as-rao8 er-5af fb-8hl fe-2dd fe-gm fo-
a3z fo-a5t fq-pm-nc-lad ne-2be ne-3bm nc-3dz nc-
3in nc-5zo ne-9cx ne-8ae oa-3jk oa-3la oa-3ot oa-
3wm oa-5hg oa-5ja oa-6dki oi-lad oz-3aj oz-3au oz-
3az oz-4ao sa-a22 x-oib xen-oq.

aj-JXIX, K. Kasahara, 880 Tennoji-cho, Osaka,
Japan

(Heard between Feb. 14 and Mar. 31, 1928)

5agm 5mx 5adh 5ajm 5akh 5alm 5alv 5am 5ans
5asi 5avk 5bgl 5bfp 5bis 5bax 5bkr 5bmt 5bmw 5bph
5bpr 5bsn 5bzy 5bzc 5bz 5bq 5bvy 5bcm 5ch 5cih
5cmw 5cog 5cq 5cub 5cwl 5cxi 5czh 5ddy 5ddq 5dev
5dfp 5dgy 5dhs 5dlh 5dqn 5dum 5ea 5ec 5ed 5gm
5hj 5hm 5jn 5ju 5ps 5tj 5t 5vf 5zf 7afz 7ajh 7bb
7ef 7ek 7fh 7ip 7j 8it 7vf 7vq 9oo oh-6bhl oh-6boe
oh-6dki oh-6dms oh-6dv oh-6vx ae-1hh ei-lay oa-2dy

Beginners! Students!

Advanced

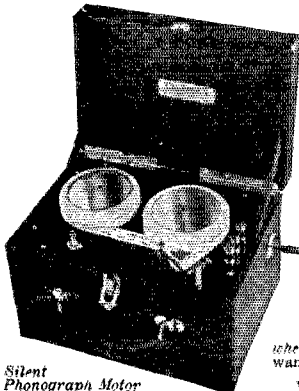

The TELEPLEX Code instructor will make you proficient in code practice in half the usual time. Teaches both sending and receiving. Reproduces actual sending of expert operators exactly as they send on the air and on land lines. Sends messages, radiograms, etc. — regular code traffic at whatever speed you desire. Endorsed by U. S. Navy and leading Schools. Complete course of instructions (Wireless or Morse) for beginners and advanced students furnished. Get the TELEPLEX and practice when, where and how you want.

Silent
Phonograph Motor

Write for booklet RL

Telex Co., 76 Cortlandt St., New York, N. Y.

QUARTZ OSCILLATING CRYSTALS

Unconditionally Guaranteed

1 in. sections ground to 1% of your specified frequency at these prices:

40-75 meters \$35.00

75-100 meters 17.50

100-200 meters 10.00

200-600 meters 15.00

Tested blanks, 2 to 3 mm thick 5.00

Sections of any practicable dimensions made to order.

Prompt Delivery

J. T. Rooney, B. Sc., 31 Calumet Bldg., Buffalo, N. Y.

"Ten years crystallographic experience"



Look This *NEW* Service Instrument Over

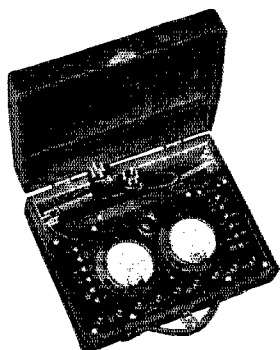

Pattern No. 199

After you have seen the new Jewell Pattern No. 199 A. C. and D. C. Radio Set Analyzer, you will agree that it has desirable features not found in similar instruments now available—features that improve and increase its value in the servicing of radio sets and equipment.

It is entirely new—designed to meet the present up-to-date service demands, with additional features that anticipate future requirements.

Some of the features which mark it as distinctly advanced in design are: A new 5 prong plug arrangement, simple push button switches for making tests, provision for an accurate tube test, a new cathode voltage test,—all of which are distinct Jewell accomplishments and worthy contributions to the advancement of radio.

The two instruments, one an A. C. and the other a D. C., have the following ranges: 0-4-8-16-160 A. C. Volts and 0-7.5-75-300-600 D. C. Volts and 0-15-150 Milliampères. All ranges are brought out to binding posts and special leads are provided for continuity tests. All D. C. voltage ranges have a resistance of 1000 ohms per volt.

The instrument case measures 9½ x 11½ x 3¾ inches and is covered with genuine Morocco leather. The complete set weighs 7½ pounds and is equipped with a handy carrying handle.

A new descriptive circular No. 2002 gives complete details of its special features. Write for a copy.

Jewell Electrical Instrument Co.

1650 Walnut St., Chicago

"23 YEARS MAKING GOOD INSTRUMENTS"

BECOME A RADIO OPERATOR

See the World. Earn a Good Income.
Duties Light and Fascinating.

LEARN IN THE SECOND PORT U.S.A.

Radio Inspector located here. New Orleans supplies operators for the various Gulf ports. Most logical location in the U.S.A. to come to for training.

Nearly 100% of radio operators graduating on the Gulf during the past five years trained by Mr. Clemmons, Supervisor of Instruction. Start training now for summer and fall runs.

Member of the A.R.R.L.—Call "5 G R"

Day and Night Classes—Enroll anytime—Write for circular.

GULF RADIO SCHOOL

344 Howard Ave.

New Orleans, La.

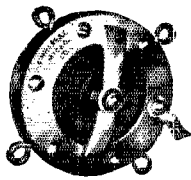

2-Button Broadcast Type Microphone \$15.00

Can be used with or without amplification. Operates on 5 to 15 mills per button.

Standard broadcast microphones.

Extra heavy—latest features—large buttons. Solid back—Unconditionally guaranteed. PRICE \$60.00

Condenser microphones—No hiss—No blasting—requires no repairs or adjustments. Fine characteristics. PRICE \$200.00

Send for Catalogue.

Guaranteed microphone repairs. 48 hour service

UNIVERSAL MICROPHONE COMPANY
Chamber of Commerce Bldg. INGLEWOOD, CALIF.

FORESIGHT

Says:

Standard Apparatus for best results!

SIGNAL PRACTICE SETS



Key & buzzer
Set \$2.70

Signal Buzzer 1.25

Neon Bulbs G.E. 55c

No. 12 Enamel Aerial Wire per .. 100 ft. 90c

Bakelite cut to size, per sq. inch .. 02c

Bradleystats for 210 tubes 2.95

R.E.L. 852 Sockets 1.80

Thordarson Fil. Trans. 7½ Volt

C.T. 35 V.A. 6.35

Thordarson 2098-550 Volt each side

plus 2-7½ Volts fil. Windings ..13.95

Acme 200 Watt 550-750 Volt each

side plus 2 fil. windings \$16.75

Complete line of Ward Leonard ap-

paratus.

5000 Ohm C.T. 44 Watt \$1.50

Free Short Wave catalogue will be

mailed upon request.

All Mail Orders promptly filled upon

receipt of Money Order including

postage.

WIRELESS EGERT

179 GREENWICH ST.

NEW YORK CITY

Announcement

To meet the demands of those who prefer a vitreous coated resistor, Hardwick, Field, Inc., announces the release of a complete line of this type in addition to the regular line of specially processed cement coated resistors.

Vitreous enamel coated resistors can be supplied in a wide range of values and carry the usual Har-field assurance of accuracy and dependability.

May we not have the privilege of assisting you in your resistor problems by submitting samples made to your specific needs?

HARDWICK, FIELD, INC.

SALES OFFICE
122 Greenwich St.
New York City



FACTORY
215 Emmett St.
Newark, N. J.



The Ideal "Mike" for any purpose, broadcast or amateur phone, public address systems, etc. Two button stretched diaphragm type, priced at only \$40.00. Split Primary Microphone Transformer, \$10.00.

A New Standoff Insulator
No. 20 is already used by thousands of Hams. 2 3/4 inches high, price 20c.
No. 60, the new one, is similar, but 4 1/4 inches high and with ribbed surface Splendid for high voltages, lead-in bushings, supporting antenna and ground lead, etc. Price 60c.



E. F. JOHNSON CO.,
Waseca, Minnesota

Marconi transformer, 5 kw 500 cycle type E 13 catalogue No. 4320, pri volts 220, sec. volts 12,500 for \$30 00; U. S. Navy Long Wave Receiver, type CP. 33, range 1000-10,000 meters, mkr. DeForest Tel. & Tel. Co. Up to date set. Tuned Pri. Tuned sec. Tickler regeneration. Detector not incorporated in cabinet. Condition O. K. but used for \$25.00; Weston Electric Inst. Co. Ammeter scale 0-150 amps. Internal shunt 8 inch face, zero center for \$15.00; Largest stock of Government Radio Transmitting and Receiving material in U. S. Send 2c stamp for our new and latest reduced price list. Ship anywhere. WEIL'S CURIOSITY SHOP, 20 South 2nd St., Philadelphia, Pa.

oa-2lg oa-2sh oa-2yj oa-3do oa-3wm oa-4lj oa-4rb oa-5by oa-5aw oa-5hg oa-5wa oa-7cw oz-1ad oz-1rn oz-2be oz-2bp oz-2bx oz-3ar oz-3az oz-4am od-1ad od-1ao od-4ar oc-5aw oc-5gf sb-2aj sb-2as sb-3nm sc-2as sc-3tc su-1aj su-1oa su-2bt xep-1ma.

eb-4KD, A Blancquaert, 20 Rome St., Loreren, Belgium

1amu 1bk 1ia 1cpl 1asr 1no 1adb 1mk 1apc 2azk 2bly 2exl 2hjq 2acd 2atx 2ble 2ejd 2arb 2dg 2anh 2bhd 2brh 2brz 2bu 2na 2nw 2ao 2sh 2af 2ac 2aev 2ef 2om 2apw 2axa 2cpd 2awu 2bbs sb-1ay sb-1aw sb-1ay sb-1ax nq-5ea te-egcz.

1BUX, D. H. Borden, Touisset, Mass. (20 meters)

eb-4aa eb-4au eb-4cb eb-4rs eb-4uu ee-1ab ee-2yd ee-7bb ee-7jo ee-7zg ee-ar65 ee-8ar0 ee-8bf ee-8br ee-8cp ee-8et ee-8fd ee-8eo ee-8fd ee-8fr ee-8gr ee-8hip ee-8ho ee-8hz ee-8jr ee-8kl ee-8orm ee-8yee ee-2ao ee-2ax ee-2bm ee-2jp 2g-2ju ee-2kf ee-2ms ee-2nh ee-2nm ee-2od ee-2sc ee-2vq ee-2vx ee-5ad ee-6at ee-5br ee-5by ee-5fs ee-5kl ee-5ma ee-5ml ee-5mo ee-5ms ee-5qv ee-5skeg-5uo ee-5uw ee-5vl ee-5wk ee-5yx ee-5yx ee-6bd ee-6by ee-6cr ee-6dr ee-6gz ee-6hp ee-6ht ee-6oh ee-6oo ee-6pi ee-6qb ee-6rb ee-6rw ee-6td ee-6uf ee-6ut ee-6vj ee-6vo ee-6vp ee-6wd ee-6wl ee-6wy ee-6yq ee-6vj gi-2it gi-6mu ei-1au ei-1bs ei-1dv ei-1fp ei-1gl ei-1gw ei-1kz ej-7dd ek-4jk ek-4jl ei-1ak em-smuk em-smus em-smuv em-smuz en-orz en-ova en-owim eo-17c eo-18b ep-1aa ep-1ae ep-1by es-2nx fm-tun2 fo-83z fo-88p na-7adg na-7mm na-7nr np-4ia np-4sa np-4xk nq-2kp nq-2mw nq-5nb oa-2hm oa-2hj oa-2mh oa-2sh oa-2ss oa-2uk oa-2yi oa-3bk oa-3cp oa-3dc oa-3gr oa-3hl oa-3jc oa-3kr oa-3my oa-3ta oa-3wq oa-3xo oa-4fk oa-4lj oa-4ly oa-4by oa-4dx oa-4hg oa-4jz oa-4m oz-1ao oz-1fe sb-1aa sb-1ah sb-1ib sb-2ar sb-nob sc-2ac sc-3ac sc-3ar sc-3c anf-fzs xnu-kdwn 1co oib peh rjc rkv tve xnu-wsq wnp.

(40 meters)

ea-kl eb-4ar eb-4au eb-4bv eb-4bu eb-4cb eb-4ck eb-4dl eb-4dx eb-4fp eb-4ft eb-4lc eb-4rk eb-4wx ee-aa2 ee-7ly ee-ar10 ee-ar28 ee-ar77 ee-8ar0 ee-8axq ee-8br ee-8cp ee-8eo ee-8est ee-8ez ee-8fc ee-8fd ee-8ff ee-8fr ee-8gr ee-8gyd ee-8hip ee-8hz ee-8ix ee-8jc ee-8jb ee-8jf ee-8jt ee-8kv ee-8kl ee-8lx ee-8orm ee-8ssy ee-8vd ee-8vu ee-8wb ee-8wz ee-8wz ee-8z ee-8ze ee-8fn ee-2lz ee-2up ee-5uw ee-5yx ee-6bd ee-6rm ee-6td ee-6yq ee-6yq ee-6vj gi-6mu ei-1as ei-1au ei-1ay ei-1bs ei-1ce ei-1cr ei-1dc ei-1dy ei-1et ei-1fp ei-1gc ei-1it ei-1mg ei-1za ej-7dd ek-rau ek-4ds ek-4oa ek-4uh ek-4uai ek-4uf ek-4yo em-smtn em-smus em-smuf em-smuk em-smus em-smuv ep-1ae ep-1bl ep-1bx ep-1cf ea-2nm ee-4nb ei-tpai et-tpmm fa-8pm fl-1ab fn-1aw fo-af7 fu-6m fu-8hp fu-ocya nb-be8 nj-2pa nm-1l nm-1rz nm-9a nm-xc51 nm-1nic np-4ap nq-2ac nq-2ef nq-2iq nq-2jt nq-2kp nq-2ro nq-5by nq-5cx nq-5fl nq-5nin nq-7ef nr-eto nr-2ags oa-2bv oa-2dy oa-2fp oa-2hm oa-2jw oa-2lg oa-2mh oa-2ms oa-2ns oa-2rb oa-2rt oa-2rv oa-2v oa-2sh oa-2tm oa-2yi oa-2yj oa-3al oa-3bd oa-3bk oa-3cp oa-3ew oa-3gt oa-3hr oa-3ij oa-3jk oa-3jo oa-3kr oa-3lc oa-3lp oa-3ls oa-3my oa-3od oa-3pi oa-3px oa-3tm oa-3ut oa-3vp oa-3w oa-3wm oa-3xo oa-3xo oa-4ab oa-4bd oa-4go oa-4ph oa-4rb oa-4wa oa-5bw oa-5bx oa-5by oa-5dx oa-5hg oa-5jc oa-5jh oa-5mb oa-5mr oa-5qp oa-5si oa-5wa oa-5wh oa-5xg oa-6mu oa-7dx oa-7lj oz-2ab oz-2be oz-aw oz-3au oz-3az oz-4am oz-4av sa-ne3 sa-dq sa-fc6 sb-1ah sb-1aj sb-1al sb-1ao sb-1aq sb-1as sb-1aw sb-1bg sb-1bo sb-1ca sb-1cx sb-1cj sb-1cm sb-1ld sb-2ab sb-2af sb-2ag sb-2ah sb-2as sb-2id sb-2ig sb-2ih sb-5aa sb-5bf sb-7ab sb-8ni sc-1ai sc-2ab sc-2as sc-3bd sk-2ah sj-3bx su-1oa su-1pe ardi.

oa-3AB, J. W. Leonard, 18 Love St., Black Rock, Victoria, Australia

(Heard during March on 40 meters)

1cmf 2ase 2ayj 2mb 2au 4sj 5at 5aci 5bj 5ja 5mx 5ox 5rk 6add 6ayj 6avl 6awk 6am 6ard 6al 6bz 6bhl 6by 6bz 6bf 6bz 6bn 6cz 6cz 6ck 6dow 6dx 6dko 6dho 6ga 6fs 6vn 6va 6zxm 7afz 7ek 7lt 7pv 7qu 8avs 8bau 8czr 8dd 8gz 8vn 8avp 8aok 8acu 8ase 8adq 8afz 8aoo 8bez 8bc 8bh 8ck 8ca 8ch 8cjh 8che 8ep 8dng 8eob 8eul 8ff 8gv 8tn 8uu oh-6adh oh-6aim oh-6be oh-6el oh-6dd oh-6de oh-6ek ac-2ek ac-8na aj-5k aj-1gs xop-ldr op-1ad op-1cw op-1qd op-1rc oa-1aj oo-bam oo-dgk oo-faz oc-5co ee-2od ee-gia eb-4bc eb-4ft eb-4wx ee-8cp ee-8fr ee-

PILOT brings the latest in RADIO within reach of all!



PILOT'S "FLYING LAB"

Equipped with Pilot Short-Wave Radio Apparatus, the Pilot Airplane Radio Laboratory will be the first airplane radio station to communicate with amateur experimenters. This is the Pilot Company's contribution to the development of a communication system which promises to be a great aid to the safety of air travel, enabling pilots to receive weather reports, fog and storm warnings while flying.

A RESEARCH laboratory surpassed by few, manned by engineers who've grown up in radio, backed by a factory with unexcelled mechanical equipment—these are a few of the reasons for Pilot quality, Pilot precision and Pilot engineering leadership.

Volume production permits manufacturing economies which are reflected in the popular prices of all Pilot Radio Parts.

Send 4c Stamp for Catalog

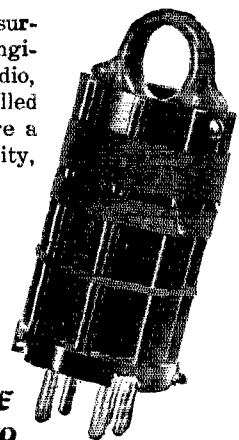

One of the set of five PILOT SHORT WAVE PLUG-INS equipped with Vari. Colored Handles Each Designating Wave Band from 17 to 500 Meters.

RADIO'S BIGGEST 25¢ VALUE!

"RADIO DESIGN," a Quarterly Magazine edited by M. B. Sleeper, national radio authority, is brimming over with the newest and latest Short Wave, A.C. Data, Power Amplification, latest Television Development, etc. Send 25c stamps or coin for four meaty quarterly issues.

Name

Address

PILOT RADIO PARTS ARE SOLD IN EVERY CIVILIZED COUNTRY IN THE WORLD!



PILOT
ELECTRIC M'FG. CO., INC.
323 BERRY ST. BROOKLYN, N.Y.

To Our Readers Who Are Not A. R. R. L. Members

Wouldn't you like to become a member of the American Radio Relay League? We need you in this big organization of radio amateurs, the only amateur association that does things. From your reading of *QST* you have gained a knowledge of the nature of the League and what it does, and you have read its purposes as set forth on page 6 of every issue. We would like to have you become a full-fledged member and add your strength to ours in the things we are undertaking for Amateur Radio, and incidentally you will have the membership edition of *QST* delivered at your door each month. A convenient application form is printed below—clip it out and mail it today.

..... 1928

American Radio Relay League,
Hartford, Conn., U. S. A.

Being genuinely interested in Amateur Radio, I hereby apply for membership in the American Radio Relay League, and enclose \$2.50 (\$3 in foreign countries) in payment of one year's dues. This entitles me to receive *QST* for the same period. Please begin my subscription with the issue. Mail my Certificate of Membership and send *QST* to the following name and address.

.....

Station call, if any

Grade Operator's license, if any

Radio Clubs of which a member

Do you know a friend who is also interested in Amateur Radio, whose name you might give us so we may send him a sample copy of *QST*?

.....

Thanks!

FROST-RADIO FROST-RADIO FROST-RADIO FROST-RADIO FROST-

FROST-RADIO

New Data Book Now Ready

The new Frost-Radio 16 page Data Book, just off the press, is ready for mailing. It contains a great deal of valuable information regarding circuits but also technical data on rheostats, variable high resistances, filter condensers, etc. We have aimed to make this a complete authoritative manual of interest to every reader of QST. Write for your copy today, inclosing 10c to cover cost of postage and mailing. Also contains full information on the new Frost-Radio items for 1928.

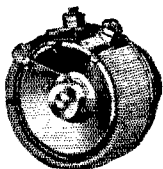

HERBERT H. FROST, INC.

Main Office and Factory
Elkhart, Indiana

Chicago New York City

HERBERT H. FROST, Inc.
160 North La Salle Street, Chicago

Send me by return mail your NEW 16-page Data Book for which I inclose 10c.

Name

Street Address

City

State

Model "N"
Vario Denser

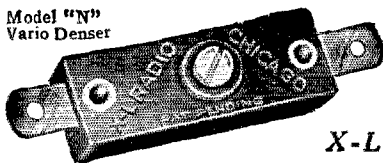

Pep Up
Your Set
With
X-L Products

Tune quickly—adjust accurately—eliminate distracting noises—get correct tube oscillation—with X-L VARIO DENSERS in your circuit. Designers of all latest and best circuits specify and endorse.

MODEL "N"—Micrometer adjustment easily made, assures exact oscillation control in all tuned radio frequency circuits, Neutrodyne Roberts 2-tube, Browning-Drake, Silver's Knockout. Capacity range 1.8 to 20 Mfd. Price \$1.00.

MODEL "G"—Obtains the proper grid capacity on Cockaday circuits filter and intermediate frequency tuning in super-heterodyne and positive grid bias in all sets. Capacity range. Model G-1 .0002 to .0001 Mfd. Model G-5 .0001 to .0005 Mfd. Model G-10 .0003 to .001 Mfd. Price each with grid clips \$1.50.

X-L PUSH POST—NEW! Bakelite Insulated. Push it down with your thumb, insert wire, remove pressure, wire is firmly held. Vibrations will not loosen, releases instantly. Price each 15c.

FREE—New up-to-date book of wiring diagrams, showing use of X-L units in all popular hookups, also the Goodwin Aperiodic Detector Circuit, applicable to any set; adds a stage without added tuning controls. Write today.



X-L PUSH
POST

X-L RADIO LABORATORIES,
Dept. D, 1224 Belmont Ave., Chicago, Illinois

NATIONAL

Velvet Vernier Precision Dial Type N. A Solid German Silver Dial with the original Velvet Vernier Mechanism and a real vernier reading to 1/10 of a division. Ideal for short-wave work.

Send for Amateur's Bulletin 127
NATIONAL CO., INC., MALDEN, MASS.

8fc ef-8fd ef-8la oz-1an oz-1aa oz-1ab oz-1al oz-1al
oz-1ai oz-2aa oz-2ab oz-2aw oz-2ae oz-1fe oz-1fu
oz-2be oz-2bf oz-2bp oz-2bd oz-2bu oz-3ar oz-3aj oz-
3aw oz-4am oz-4ae oz-4ac.

ei-IDY, A. Ancilotto, Treviso, Italy
(Heard between Jan. and March)

1aba 1adm 1aep 1aft 1afx las law lara lasf 1ale
1ahv 1akd 1azt 1ary 1axl 1axa 1age 1alb 1asy 1aom
1awe 1bk 1bw 1bhs 1bkp 1bed 1bms 1co 1cd 1cx 1cax
1cnz 1caa 1cpb 1chr 1di 1gh 1ij 1mo 1mr 1od 1pc
1qv 1ry 1vy 1vw 1vs 1ww 1yc 1zadd 2afx 2ass 2app
2avw 2anx 2box 2bfj 2brm 2bek 2bx 2bui 2baz 2br
2dp 2ge 2fn 2gw 2hc 2mpo 2mt 2md 2pso 2tp 2vl
2vy 2ag 2any 2ape 2ans 2akw 2bmc 2buu 2bqq 2bms
2ckj 2nr 2pf 2ps 2qe 2sz 2ts 2oc 2ft 2nl 2rd 2sh 2adg
2avp 2ayu 2box 2bgk 2bhs 2ben 2bbs 2cns 2erz 2ded
2dsi 2don 2dmt 2il 2arn 2an 2alr 2cn 2dbj 2fbc
2rp nr-2fg nr-2ags nr-1am nr-1ar nr-1ak nr-1g nr-1a
nr-1a nr-2jt nr-2jt nr-2ro 2q-5v af-1b ag-rann ag-
67ra ar-2kx al-2kw al-2kt al-2kt al-11ra as-ra03 as-19ra as-
69ra sa-osa aq-1lm aq-1ds aj-jbbn fe-gez fe-1es fe-1ac
fe-gm fm-8sr fm-8jo fo-a9o fo-a9l fo-1sr fo-af4 sb-
lah sb-las sb-lak sb-law sb-1ca sb-1cm sb-1ck sb-
1bg sb-1id sb-2ag sb-2az sb-2id sb-2as sb-2ar su-1oa
su-1br oa-3vp oa-3ot oa-4db oa-5by oa-5hg oa-7ch oz-
1ap oz-1fe oz-1bd oz-1fb oz-2bp oz-2bx oz-2xa oz-3al
oz-3az oz-3au oz-3ar oz-4am oz-4aa wnp.

Cpl. Edward J. Day, opr. WUCG, Hdqrs. Battery 1st
C.A., Fort de Lesseps, C. Z.

1ae 1wg 1bed 1cep 1ii 1mo 1mv 1aw 1bl 1ado 1ah
1app 1om 1br 1chg 1xc 1co 1bnh 1xv 1awe 1cax
1aac 1sz 1ka 1ao 1urn 1ry 1td 1ed 1uv 1ape 1ex
1bke 1z 1gw 1axp 1bgt 1cpj 1nic 1age 1ack 1epb
2bq 2afz 2ag 2bad 2bfv 2cbr 2evi 2fg 2gw 2mu 2af
2tp 2fr 2bh 2ern 2bec 2ang 2vt 2eei 2gu 2xam
2baa 2xad 2xaf 2xb 2awq 2xs 2xr 2afx 2mg 2xbc
2mk 2tp 2bae 2sb 2gp 2api 2bdf 2ebb 2gc 2ff 2atx
2ch 2afx 2my 2bxr 2anm 2avb 2adi 2bjy 2pf 2cc
2sz 2fg 2afk 2aks 2aim 2cg 2bgn 2alq 2ab 2ld 2akv
2ke 2afp 2lz 2ee 2aom 2ec 2af 2ur 2iq 2nq 2k 2ax 2uo
2ff 2pd 2oo 2rm 2pz 2nl 2bl 2ld 2km 2jg 2rf 2aa 2acy
2et 2ds 2gq 2ok 2ud 2hd 2bf 2ry 2zav 2ac 2ch 2ma
2fy 2yd 2amw 2kp 2pt 2pr 2gm 2ael 2ahn 2haj 2tx
2vp 2eve 2xi 2ecx 2ard 2oq 2adg 2adm 2axa 2arx 2kx
2asf 2baf 2eft 2eug 2efr 2dpo 2bc 2vj 2bto 2ajo
2lt 2eil 2gng 2eug 2eam 2ev 2est 2er 2djh 2afz 2app
2hx 2ard 2efv 2fac 2efz 2avl 2ec 2er 2bgn 2ala 2au
2afm 2ark 2ez 2et 2am 2c-3cc ne-3dg ne-1rnh nr-
2fg nr-2ags nr-2ea ne-2q ne-5fl ne-6kw ne-2iq ne-
ca eg-5hs eg-5w eg-2ld eg-2ll eg-6cr eg-2lh eg-2zv
np-4sa ef-8vu ef-fw ef-8jf ef-8f eb-1fw eb-4bd ei-1dy
ei-1rl ei-1nv oz-4am oz-2xr oz-4av oz-8am oz-2bp oa-
3lo em-smuf.

Central Division Convention (Michigan Section)

THE Michigan State, Central Division Convention was held at the Hotel Olds at Lansing on April 27 and 28, and if all small conventions are like this one, this particular member of Headquarters staff craves to be sent exclusively to small conventions.

Things started on time—so much so that Director Darr, Doc Witter, Al Fuller and the writer, who drove up from Detroit and arrived at 2:15 Friday instead of 2:00, found themselves out of luck for the official opening and the trip to the telephone and telegraph companies. However, we located some hams in a similar predicament and spent a thoroughly enjoyable afternoon in that most pleasant diversion—chewing the rag informally with similarly-minded fellow-amateurs.

At the evening smoker, Prof. B. K. Osborn led off with a masterly talk on distortionless amplification, and an explanation of the differences between static and dynamic characteristics of vacuum tubes—good

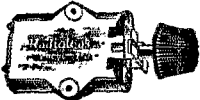

Bradley Leak, absolutely noiseless and stepless, 2000 to 30,000 ohm resistance. List \$5, special \$2.95.

\$4. Bradleystat No. E-210 Special1.60



Signal Buzzer Set International Code on Baseboard \$2.45

Heiden braid 1/4 inch wide, ft. .06

Myers \$5 4 1/2 volt Det. or Amp tube, complete with mounting clips95

LEEDS

The Home of RADIO
45 VESEY STREET
NEW YORK

New York's Headquarters for Transmitting Apparatus

When in Town Visit Our Store

Full Line of Acme -- Thordarson -- Jewell -- Flechtheim -- General Radio -- Signal -- Bradley

SPECIALS

Dubilier Mica Condenser, .002 cap, 5,000 working volt 1.95
General Radio 247D .001 cond. plain or with vernier 1.75
Dubilier cond. 1.7 mfd. 1,000v D.C. test; 650v. working voltage 1.35
Dubilier cond. .5 mfd. 1,000v D.C. working voltage 1.85
R.C.A. - U.V. 1716 Super Het. transformer 1.45
Ward Leonard Resistances; fits standard bar receptacles; sizes 300-600-900-1200 and 2000 ohms .95
\$15. Imported German head sets; very sensitive 3.45
Honeycomb Coils unmounted, all sizes in stock at 1/2 price.
\$8 Signal Corp adjustable arm micro-transmitter for panel mounting 2.45
\$9. Dubilier condenser, 4mfd; 600 v. D. C. working type 903; limited quantity 2.25
R.E.L. Transmitting Inductances, per set, 3.50
Bristol 50 Henry choke 2.75
6.50 Acme .0005 enclosed condenser .95

Neon Glow Lamps, made by General Electric Co., type G.10, standard base. 101 uses, as illustrated in QST May issue page 1755

Flechtheim Condensers, all types 35% off list.

Pyrex Low-loss V.T. sockets, each 39c.

MAIL ORDERS FILLED SAME DAY
10% Must Accompany All Orders

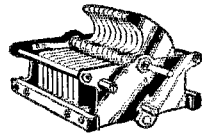

Cardwell condensers, double spaced for transmitting, .00025 cap. 3.45

No. 12 Enameled copper wire, any length, ft. \$.01

No. 10 Enameled copper wire, any length, ft.01 1/2

Genuine Bakelite Panel 10x14 1/4 1.50

Baldwin phones type C, pair 5.95



Ward Leonard Resistance \$4.75 list-6 1/2 inch long-800-1000-1200-3000-6000-8000-11000 ohms; can be used for 2-50 watt tubes or less. \$1.45

Thordarson Power Transformers
\$19 list-T-125, cap. 100 watt, secondary each side of neutral 850 and 850 volts, \$9.85.
\$18 list-T-126, cap. 450 watt, secondary each side of neutral 1000 and 1500 volts, \$13.95.
\$30 list-T-127, cap. 900 watt, secondary each side of neutral 1000 and 1500 volts, \$22.50.

Acme C. W. 30 Henry Choke \$18 list-150 M.A. single, \$14.40, also other sizes at special prices.
General Radio No. 358 Short Wave Meter, 14 to 225 meters, list \$22, special \$17.80

DODGE RADIO SHORTKUT

With Appendix and Hints for Better Key Work. Fixes Signals in mind to stick-Kills Hesitation, Cultivates Speed and Good Fist-Produces Results. Slow Hams raise speed to 25 per in few evenings. Previous Failures qualify and pass exam quickly. Beginners master code and pass in ten days.

DODGE HIGH SPEED METHOD

(Intensive Speed Practice)
Quickly puts 25 per Hams in 35-40 per class. Five Hams report made this gain in few evenings. One of them by 75 minutes total practice only.

DODGE MORSE SHORTKUT

Easily mastered by Radio Ops-Kills tendency to mixup or confusion. Either code used as desired.

REPORTS FROM USERS

Tell the complete story-Mailed on request. Radio \$8.50. High Speed \$2.50. Morse \$2.50. Money order. None C. O. D. Foreign add 50 cents.

C. K. DODGE, MAMARONECK, NEW YORK.

PACENT DUO-LATERAL COILS

FOR laboratories, experimenters, engineers and for special circuits, Pacent Duo-Lateral Coils are the accepted standard.

A complete line of all standard turn ratios are always in stock.

Write for information and prices

Pacent Electric Co., Inc.
91 Seventh Avenue, New York

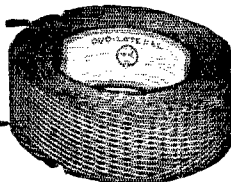

AMATEURS

The Most Interesting Field for Experimenters.

Light Sensitive Cells

...AND...

Their Applications

PHOTO ELECTRIC CELLS

have been used in Television, Telephotography, Talking Movies and innumerable uses with:-

RADIO RELAYS

Our special polarized relay, a result of long research for a practical relay to be used with-Light Sensitive Cells-also used in connection with telegraph-printers, receiving time-signals and many applications in radio.

Write for further information:-

Photo Electric Devices, Inc.,
594 Fifth Avenue Brooklyn, N. Y.

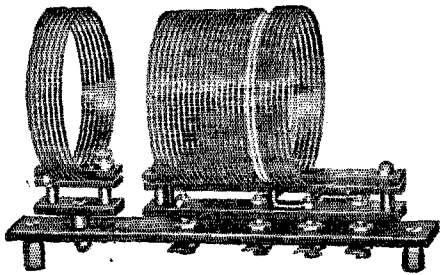

The **CHI-RAD**
Short Wave Coils

20—40—80 Meter Band

Designed by Chi-Rad engineers to meet the demands for an extremely efficient short wave coil. Complete with mounting, hardware and three interchangeable plug-in coils to cover 20, 40 and 80 meter wave bands. These coils are noteworthy for their convenience in design, neatness in appearance and sturdiness in construction. All plugs give positive contact.

Chi-Rad Short Wave Coils Complete for 20, 40 and 80 meter band net price \$7.50
Extra coil for broadcast band ... net price \$2.45
Dealers and Set-builders—write for further details and discounts.

CHICAGO RADIO APPARATUS CO.

415 South Dearborn St.

Chicago, Ill.

Electro-Bug, Jr., \$12.50

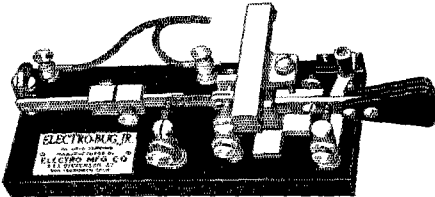

A full size, highest class instrument. Special introductory terms—half with order, half in 30 days. Five-day trial, money refunded if not satisfactory. SPECIAL WIRELESS MODEL \$17.00. $\frac{3}{8}$ " silver contacts, extra heavy cord, will work any hook up. Same terms and guarantee of satisfaction as Junior.
ELECTRO MFG. CO., 443 Stevenson St., San Francisco, Calif.

ROBERT S. KRUSE

Consultant and Technical Writer

103 Meadowbrook Road,
West Hartford, Conn.

Telephone Hartford 45327

AEROVOX Makers of high quality resistors and condensers that are Built Better — to endure.
Write for The Research Worker.
A free monthly publication.
AEROVOX WIRELESS CORPORATION
66 Washington Street Brooklyn, N. Y.

dope for any amateur. Following this R. H. G. Mathews, of 9ZN fame, and Lt. L. T. Hayes spoke so eloquently on the Naval Reserve that 25 fellows signified a desire to join. In which connection it might be mentioned that Matty, not to be outdone, wired for a Navy doc to be present Saturday, and at that time 20 fellows were duly examined and sworn in. This is a record to be proud of! Spirited contests and some fine movies wound up the formal evening session, but general 'hamming' in the lecture room and various of the hotel rooms kept up far, far into the night.

Saturday morning was taken up with a fine traffic session and remarks on 1929 by Director Darr, followed by a cleverly-done humorous argument between L. V. Wells and Dr. Woodruff, Director of the Atlantic Division, on the hoary subject of power factor. Remember it?

After lunch occurred one of the finest technical sessions it has ever been the pleasure of this writer to attend. Good, solid amateur dope from start to finish. The talks of Mr. Marburger, of Kalamazoo Teachers' College, and Mr. Pancost, SZF, were so good that we hope to get them for QST. Budlong, from League Hq, spoke on 1929 receivers and ten meters, and Director Woodruff finished with a splendid discussion of amateur transmitter and receiver problems, with demonstrations of the apparatus he talked about.

One hundred amateurs—some of them y'l's—crowded the hall for the banquet that night, with Matty acting as toastmaster. Short speeches were followed by the distribution of prizes won in the various contests and drawings for others. To say that excitement ran high during this part of the convention is putting it very mildly indeed.

Eventually, the last speech was made and the last prize awarded and the convention was officially over. The committee that put it over can be proud of themselves—we hope we get out to the Michigan convention next year.

A. L. B.

RADIO OPERATORS WANTED

THE EASTERN RADIO INSTITUTE can train you quickly and thoroughly because:

MODERN AND EFFICIENT METHODS
THOROUGH INSTRUCTION under staff of LICENSED COMMERCIAL OPERATORS
MODERN APPARATUS including SHORT WAVE TRANSMITTER

FIFTEEN years a RADIO SCHOOL
THE OLDEST, LARGEST and MOST SUCCESSFUL school in New England. RECOMMENDED BY THE A. R. R. L.

Day or Evening Classes Start Every Monday.

SPECIAL CODE CLASSES

Write for Illustrated Prospectus

EASTERN RADIO INSTITUTE

899 BOYLSTON STREET BOSTON, MASS.

Have you a 'Back Copy' file?

If not you should have, for reference is continually being made in QST articles to previous issues

All 1925 copies (except January)	- - -	\$2.50
All 1926 copies	- - -	2.50
All 1927 copies	- - -	2.50

All Three Years for \$5.00, a saving of \$2.50 if all three years are ordered.

If you do not want all copies, state which years are wanted.

Any Individual Copy - - - 25c

Binders to keep these files in order - - - \$1.50 each

Will hold 12 issues of QST and does not mutilate the copies.

QST

1711 Park Street

Hartford, Conn.

JACOBS ANTENNA SPREADER

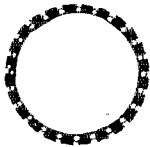

Made in Both 5 in. and 7 in. diameter
Patented Sept. 8, 1925; Sept. 7, 1926

Used whenever and wherever rapid and efficient 4, 6 or 8 wire cage antenna or counterpoise construction is required. Price \$6.00 per dozen; \$3.25 for a half dozen.

CHARLES F. JACOBS, (2EM)
279 Park Place, Brooklyn, N. Y.

Learn Radio Operating

Day and evening classes. Full or part time employment service. Write for details.

Radio Dept.

FEDERAL RAILWAY INSTITUTE

517-25 Wells St. Milwaukee, Wis.

(Incorporated 1919)

DON'T LOSE

A minute of full band operation. Get ready now. You'll need that sharp, cutting, distinctive note that will make your station stand out and gladden your heart when you listen in after a call. Only a mercury arc rectifier will do it. Use your vacation time to improve your station or loaf now and call your head off next winter. We're with you. Write now and your rectifier problems are solved.

RECTIFIER ENGINEERING SERVICE

4837 Rockwood Road, Radio BML, Cleveland, Ohio.

Freshman Power Transformers

Complete Power Supply for 210 Transmitter or Power Amplifier. Supplies Plate Voltage of 375 Volts, Filament Voltages of 7½ volts (Center tapped) for 210 and 281 tubes, also "C" Bias for 210.

SPECIAL \$3.00 Ea.

AMERICAN SALES CO., 19-21 Warren St., N. Y. City

Where are your six copies of QST for this year?

Certainly you need a binder for your 1928 copies as issued—

One-fifty each, post-paid

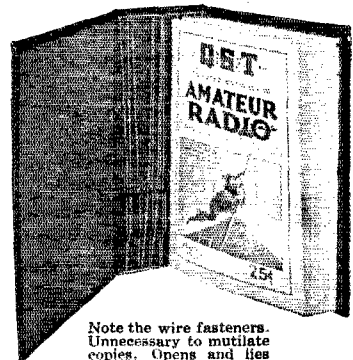

Note the wire fasteners. Unnecessary to mutilate copies. Opens and lies flat in any position.

A binder will keep your QSTs always together and protect them for future use. And it's a good-looking binder, too.

QST

1711 Park St., Hartford, Conn.



Approved Parts

(Transformers, Chokes and Condensers)
for the

New UX No. 250 Power Amplifier Tubes

For the popular new UX No. 250 P. A. Tube Dongan laboratories have perfected a complete line of power unit parts. You can assure yourself of the maximum in performance with the proper Dongan parts, designed specially for use with this tube.

No. 7568 - A power supply transformer.

No. 1177 - A straight power amplifier output transformer.

No. 1176 - An output transformer, for push pull amplification, designed for all types of dynamic speakers.

Condensers and chokes for the complete Filter Circuits.

Set Manufacturers and Custom Set Builders.

You are invited to consult the Dongan engineering department for any desired information for your particular requirements. Production on all types assures satisfactory deliveries.

Dongan Electric Manufacturing Co.

2999-3001 Franklin St., Detroit, Mich.

TRANSFORMERS of MERIT for FIFTEEN YEARS

You Can Quickly Become An EXPERT RADIO OPERATOR

The Candler System of Training in High-Speed Telegraphing Shows How

Theo. McElroy, World's Champion Radio Operator, endorses no other system. Read what he says—"At the Pageant of Progress, Chicago, I copied 56 words per minute for 5 minutes, establishing a new radio record, which I still hold. I owe my Skill, Speed and Steady Nerve both in sending and receiving to The Candler System." What this system has done for McElroy and thousands of others—it will do for YOU.

FREE Booklet explains system fully. Send for it TO-DAY. A post card will do. Send Now!

THE CANDLER SYSTEM CO., Dept. AR
6348 So. Kedzie Ave., CHICAGO, ILL.

QST OSCILLATING CRYSTALS AMATEUR BANDS

WE WISH TO ANNOUNCE:

1st.—That now, our crystals are capable of being used with as high a power tube as the 50 watt size.

2nd.—That we do not claim to grind the CHEAPEST crystals, but we do claim to grind only the best which is the cheapest in the long run.

3rd.—That we will ship the closest frequency crystal we have to your desired frequency, and that the frequency of the crystal will be stated ACCURATE to BETTER THAN A TENTH OF 1%.

4th.—That all crystals are absolutely guaranteed regards to output and frequency, and immediate shipment can be made on crystals in the amateur bands. Prices for grinding POWER CRYSTALS to oscillate in the various amateur bands are as follows:

1715 to 2000 Kilocycles \$15.00
3500 to 4000 Kilocycles \$25.00
7000 to 7300 Kilocycles \$40.00

Note: The above prices are effective July 1st, 1928, to be in effect until November 1st, 1928. (Add \$10.00 to these prices if crystal is to be mounted in an excellent dust-proof power mounting.)

Broadcast Band—We will grind a crystal for you accurate to plus or minus 500 cycles of your assigned frequency for \$45.00 unmounted, \$55.00 mounted. Two day shipment and all crystals guaranteed.

Crystals ground to any frequency between 40 and 10,000 Kilo-cycles. We will be pleased to quote prices on your particular requirement.

SCIENTIFIC RADIO SERVICE, "The Crystal Specialists"
P. O. Box 86, Dept. "Y" Mount Ranier, Maryland

Strays

The other day we received a letter asking if we could furnish the QRA of a short-wave phone station which, in announcing itself, had said something about Bay Toven. 'And I can't find it in my Atlas', the letter stated.

No, we had the idea he died some time ago.

Amateurs with bookshelves—and there are mighty few without them—will be interested in the new catalog 'Electrical Measuring Instruments' of the Jewell Electrical Instrument Co. The Jewell address, by the way, is 1640-50 Walnut Street, Chicago, Ill.

8GI offers a brilliant scheme for operating the transmitter and running across the street at the same time to hear the racket and key clicks on somebody's BCL receiver. The idea is to connect a 'flasher' button in the keying relay circuit, or in series with the high voltage transformer primary if keying is done there. 8GI suggests that the power rating of the button should be taken into consideration when the latter connection is used.

The idea of running the Tungar bulb without any filament power, once it has been started, is not a new one admits Hewson of 2BX-3XM. But it is not generally known, he says, that one cell of the battery to be charged can be used to start the bulb and the necessity of a filament supply therefore avoided. The positive terminal of the battery is connected to one filament lead as usual and the negative terminal of the first cell is connected to the other filament lead through a push button. It is hardly necessary to mention that the scheme will not work if the battery has been 'run flat'.

HAM-ADS

ANNOUNCEMENT

Effective with the October, 1928, issue of QST the following changes will be made in the rules of this department. The Ham-Ad rate will be 15c per word. The restriction which has limited use of this column to members of the American Radio Relay League will be removed and advertising may be signed either by company name or by an individual. A special rate of 7c per word will apply to advertising which is obviously non-commercial in nature and which is placed and signed by an individual member of the American Radio Relay League. Please read carefully the following conditions under which advertising in these columns will be accepted.

- (1) Advertising shall pertain to radio and shall be of nature of interest to radio amateurs or experimenters in their pursuit of the art.
- (2) No display of any character will be accepted, nor can any special typographic arrangement, such as all or part capital letters, be used which would tend to make one advertisement stand out from the others.
- (3) The Ham-Ad rate is 15c per word, except as noted in paragraph (6) below.
- (4) Remittance in full must accompany copy. No cash or contract discount or agency commission will be allowed.
- (5) Closing date for Ham-Ads is the 25th of the second month preceding publication date.
- (6) A special rate of 7c per word will apply to advertising which, in our judgment, is obviously non-commercial in nature and is placed and signed by a member of the American Radio Relay League. Thus, advertising of bona fide surplus equipment owned, used and for sale by an individual or apparatus offered for exchange or advertising inquiring for special equipment, if by a member of the American Radio Relay League, takes the 7c rate. An attempt to deal in apparatus in quantity for profit, even if by an individual, is commercial and takes the 15c rate. Provisions of paragraphs (1), (2), (4) and (5) apply to all advertising in this column regardless of which rate may apply.

THE life blood of your set—plate power. Powerful permanent, infinitely superior to dry cells, lead-acid, B, B eliminators, Trouble-free, rugged, abuse proof, that's an Edison Steel-Alkaline Storage, B-battery. Upset electrically welded pure nickel connectors insure absolute quiet. Lithium-Potassium solution (that's no lye). Complete, knock-down kits, parts, chargers. Glass tubes, shock-proof jars, peppy elements, pure nickel, anything you need. No. 12 solid copper enameled permanently perfect aerial wire \$1.00, 100 ft. Silicon steel laminations for that transformer 15c lb. Details, full price list. Frank Murphy, Radio 8ML, 4837 Rockwood Rd., Cleveland, Ohio.

PURE aluminum and lead rectifier elements holes drilled brass screws and nuts, pair 1"x4" 13c, 1"x6" 15c, 1 1/4"x6" 17c, 1 1/2"x6" 19c. Sheet aluminum 1/16" \$1.00, lead \$1.00 square foot prepaid, \$1.00 or more. Silicon transformer steel cut to order .014" 10 lb. 25c, 5 lb. 30c, less than 5 lbs. 35c lb. .022" 5c less per lb. Not cut 2-7" wide 15c lb., minimum 10 lb. postage extra. Edgewise wound copper ribbon 7 sizes see January QST. Air pocket and stand off insulators 25c each. 4 for \$1.00. Glazed porcelain 5 and 6 1/4" long period on 4. Electrolytic condenser parts, \$1.50 prepaid. Geo. Schulz, Calumet, Michigan.

HAWLEY Edison element battery and parts standard for over five years. Look at our patent pending connector—no thin wire to drop off—contains 20 times more metal than regularly used. Heavy shock proof cells, fibre holders, etc. Everything for a rapid-fire "B" supply. Complete assembled 100 volt "B" \$10.00. Knock-down kits at still lower prices. Chargers that will charge in series up to 160 volts \$2.75 to \$4.00. Trickle B Charger for 90 to 150 volt "B" \$3.75. Special transmitter "B" batteries up to 6,000 milli-amp capacity, any voltage. Write for interesting literature, testimonials, etc. B. Hawley Smith, 360 Washington Ave., Danbury, Conn.

BULLETIN 66-E Lists the Ensell Radio Laboratory receivers, transmitters, wavemeters, etc., Item No. 69 and 68-A type receivers are the most modern types for amateur reception. Four and eight tubes respectively. We also make all types of apparatus for any radio purpose, including inductances, power transformers, rectifier units, filter chokes, high voltage variable condensers, plate reactors, etc. We build to order any apparatus using your parts if desired. Kit and blue print service on any power amateur station. Write for copy of Bulletin 66-E, Thos. Ensell, 1208 Grandview Ave., Warren, Ohio, 8BDN.

OMNIGRAPHS, Teleplexes, Natrometers, transmitters, receivers, chokes, meters, transformers, 50 watters, "S" tubes, motor-generators, syncs, electric receivers, portable loop receivers, Vibroplexes. Bought, sold, traded. L. J. Ryan, 9CNS, Hannibal, Missouri.

JEWELL Meters, new, 25% discount. We stock Hammarlund, Ward-Leonard, Acme, Thordarson, Pyrex, National, Cardwell, Baldwin, CeCo, Yaxley, Signal, Bakelite, Samson, Raytheon, RCA, Browning-Drake, Fleron, Ferranti, REL, Aero, Eby, Victoreen, Silver-Marshall, Tyrman, Tohe, Shield Grid Tubes, Carter, Bodine, Clarostats, Air Chrome Speakers, Exponential Horns, Abox, Kingston, Marco, Ham Call Books, Keys, Relays, Buzzers, Exide, Philco, Westinghouse, Fritts, Newcombe-Hawley. Many other lines of Ham and BCL apparatus. Tell us what you want. Discounts to Hams, dealers and custom set builders only. Roy C. Stage, Montgomery & Burt Sls., Syracuse, N. Y.

IMAGINE an organization of radio "nuts" with over 3000 clients scattered throughout the world, hundreds of them hams, all of them radiowise—dealers, builders, experimenters. Over \$40,000 stock of high-grade receiving and transmitting parts only, no sets. Spend over \$5,000 yearly on our own experimenting, carry nothing until it passes our tests. 25c will bring prepaid over four pounds, catalog, circuits, data, etc. Weekly data sheets for experimenters and builders (more reliable data than all radio magazines together)—20 weeks \$1.00, 52 weeks—\$2.50. Full dealer's discounts to licensed hams, and radiowise builders. Fred Luther Kline, Established 1920, Kent, Ohio.

FOR sale—Two complete radio transmitters, one 500 watt master oscillator power amplifier, one 500 or 750 watt crystal control power amplifier, UV204, UV204A, UX852 tubes, numerous small parts and other equipment. Write for list and prices. 9KG, Paul Harris, Graham, Brothers, Evansville, Indiana.

TRADE—Croft's American Electricians' Library, 6 volumes, never used. Cost \$14. Would like \$0 watter. Your offer? Norman Underwood, 353 W. Oakland Ave., Toledo, Ohio.

C. R. Leutz phantom receiver with current supply 30-3600 meter, cost \$485.00, first \$150.00 takes it. Whiting, 118 Wall St., Bridgeport, Conn.

ENGRAVING—Finest workmanship on radio and laboratory apparatus panels. A. L. Woody, 19 S. Wells St., Chicago, Ill.

QSL cards—\$1.00 per 100 on plain cards \$1.85 per 100 on government cards. 9BEU, 9032 Windom Ave., St. Johns Station, St. Louis, Mo.

EDISON element rechargeable B battery parts and supplies. Write for complete list. Special, 180 volt type 3-G, 1500 Ma unit, wired and assembled \$16.00 complete. Kenotron tube "B" battery charger, will charge up to 225 volts in series. \$4.75 with tube. 100 volt type 5-G 2000 Ma B battery complete \$12.50. Other voltage batteries built to order. J. Zied, 334 N. Randolph, Philadelphia, Penn.

SELL 1 204A used 100 hours \$65.00. 1 204A used 300 hours \$45.00. Advance sink rectifier nearly new \$25.00. New national UV 203 tube \$15.00 in original carton. 6 New sonatron 210's at \$5.50 each. 3 new sonatron UX 250's at \$7.25 each. Want 1 to 5 kw tube water or air cooled. W. K. McCulla, Waukegan, Illinois.

SALE. 5 watt Transmitter Complete—\$15.00—REL. Receiver 1 stage audio 20, 40, 80M. \$10.00—Multi-Volt Filament Transformer \$5.00—Multi-volt plate transformer \$5.00—24 jar Rectifier complete \$5.00—2mf. transmitting condensers \$1.00—two stage audio amplifier \$5.00—push-pull amplifier \$5.00—etc. 3anf 2121 N. 32nd Street, Philadelphia, Pennsylvania.

GENERAL Electric 12-350 volt .143 ampere dynamotor \$18. Westinghouse 10-350 volt .08 ampere \$20. Complete with effective filter, meter 0-500 volts, panel etc \$30. 500 cycle transformers \$12.50. 500 cycle generators and gasoline engine power units. 1500 volt motor generator for DC supply. Unusual machine \$150. Photographs, Henry Kienzie 501 East 84th Street, New York.

SELL—15 watt transmitter. Bargain. 9BOV, Oskaloosa, Iowa.

SALE—One GE and two Kellogg stretched diaphragm broadcast microphones. Either type \$35.00, excellent bargain. Ed. G. Raser, 321, 315 Beechwood Ave., Trenton, N. J.

SELLING out—complete station. One new Esco 1000 volt m.g. \$60. Two new 203 tubes, fifteen each, one new DeForest 250 watt tube \$25.00. One Grebe CR13 shortwave receiver, new \$20. All guaranteed satisfactory or money back. Radio 9AHG, Concordia, Kans.

G. E. transformers, 1100-2200-4400 each side tap, carry 1000W continuously. Guaranteed. 110-220 primary mounted on marble, \$12.00. F.O.B. Detroit. F. G. Dawson, 5740 Woodrow Ave., Detroit, Michigan. Ask ham who owns one.

WANT to get in communication with other Railroad Morse Operators who are operating stations. Write M. G. Barrick, SAKQ, B. & O. Railroad, Moatsville, W. Va.

ORS 4AAM Zeigler reports: "Had long wanted ORS ticket but could not qualify. Was surprised how easily and quickly made the grade when used Dodge Radio Shortkut." Method \$3.50 U. S. Elsewhere \$4.00. Money order only. C. K. Dodge, Mamaroneck, N. Y.

WILL sell 4 UV203A transmitting tubes at \$15 apiece, guaranteed O.K. Also brand new Kellogg broadcast mike at \$60. John Haren, Schuylerville, N. Y.

SACRIFICE—150 watt Thordarson filament transformer \$4.50. 80 watts filament \$3.00. 450 watt Thordarson plate 1000-1500 volts each side \$9.00. Two rectobulbs, the ideal rectifier, stand 3000 volts 250 M.A. \$8.00 each. Other bargains. Paul Delgado, 17 Bellew Ave., Tuckahoe, N. Y.

HAMS: Get our samples and prices on printed call cards made to order as you want them. 9APY, Hinds, 19 S. Wells St., Chicago, Ill.

ANTENNA insulators (glass) for power up to 150 watts, 5 inches long, each 50 cents. 0-300 volts d.c. portable "B" eliminator voltmeters, \$2.65. 75 milliamperes 50 Henry filter chokes \$2.25. 1 like new Acme 250 watt power transformer 550-1100 volts each side of center taps, \$13.00. Ed. Keers, 9CJR, 2300 E. Washington St., Joliet, Illinois.

SELL—super-sync perfect condition, \$25. Used 203A, \$8. S. W. receiver, plug-in coils, \$12. 9DNG, Lawrence, Kansas.

LARGE 22½ volt Rayovac batteries, 89c. RCA 50 watters, original cartons, \$12.00. REL 50 watt sockets, \$1.50, 6 months guaranteed new 210s also 281s each \$4.50, 6 months guaranteed 201As and 199s 79c. Readrite 2 meter tube checker, \$3.00. Resistometers 49c. RCA 535 rheostats 29c. other rheostats all sizes, 15c. Willard storage B batteries \$1.95. Kodak silent 2½ amp. homecharger \$4.75. Bradley switches 29c. Federal transformers \$1.19. pure aluminum 1/16" thick, sq. ft. 80c. Elnach 4000 ohms, grid leak 50c. rubber panels 1c sq. inch Bakelite panels 2c sq. inch. Amateur Call Books 85c. Free list, everything for hams. D. L. Marks, 125 Madison Ave., Albany, N. Y.

NEON tubes. General Electric type G10, one dollar each. Westinghouse Rectox trickle chargers without case, \$4.50. Radio 9AUB, 1281 S. Meridian St., Indianapolis, Ind.

USED vacuum cleaner motors 1/8 h.p. 100 volt A.C. or D.C. \$2. each. Ed. Lear, 1574 Fullerton, Detroit.

YOUR QSL cards represent your station to the other fellow. An attractive card suggests a good station. Our cards are neat and up-to-date, and yet our prices are unusually low. Want a sample? Drop us a card and we'll ship you the proof. 5AHU, Box 46, Comanche, Tex.

1500 Volt, ½ ampere generator connected to 3-phase motor \$125.00. 1000 Volt, 200 watt generator connected to 110 Volt motor \$75.00. 1000 Volt, 450 Watt with 10 volt filament supply connected to 32 volt motor \$150.00. ¼ Hp. 1750 speed AC Westinghouse motors \$7.50. ¼ Hp. brand new repulsion induction, 1750 speed Westinghouse motors \$27.50. 8 Volt, 10 Ampere filament generators with rheostat \$12.50. 110 Volt, 1 Ampere generators \$7.50. Converters 110 volts Dc to 75 Volts AC \$12.00. Also larger motors and generators. James Smat, 1734 West Grand Ave., Chicago, Illinois.

WESTERN Electric 250 watter, practically new, \$50.00. Ross Moorhead, 8ARO, Route 9, Box 69, Findlay, Ohio.

SALE—Jewell No. 64 radio frequency ammeter 83 amps, \$7.50. Aero coil receiver 4 coils, Thordarson Audio and mahogany cabinet, \$25.00. Crescent Lavite 5000 ohm \$2.00. List of receiver parts. Radio 8AQB.

QSL cards two color, \$1.00 per hundred. Government \$1.90. Samples. Have a couple tubes, tfr., receiver, etc. that I don't need. List. 9CKA, Corwith, Iowa.

GENUINE Western Electric VT1 tubes, \$1.00, 6 volt 14 ampere generators, \$5.00, 12 volt 7 ampere generators, \$8.00. General Electric G-10 standard base Neon lamps, as described in May QST, "Amateur Television" \$1.00, RCA rheostats, 40c. Wm. Wagner, 819 DeKalb Ave., Brooklyn, N. Y.

QSL cards, two colors, government post cards, \$1.90 per hundred, white cards \$1.00. Real ham stationary at \$1.40 per hundred sheets and envelopes, pad form. Postage 10c. Free samples. SDTY, 257 Parker Ave., Buffalo, N. Y.

POSTPAID and guaranteed brand new. Readrite panel mounting, flush type Milliammeters, 0-300 or 0-400 Mils. Either type, \$1.25. Readrite 0-15 A.C. Voltmeters, flush type, \$3.00. R.E.L. 2000 volt working voltage filter condensers. 1 Mfd., \$3.10; 2 Mfd., \$5.50. Sangamo .002 Mfd. 5000 volt tested fixed condensers, \$1.75. General Electric 5000 ohm Heavy Duty Grid leaks, \$1.25 R.E.L. 5000 volt working .002 Mfd. fixed condensers, \$7.50. Other prices on request. G. F. Hall, 535 West Horster St., Philadelphia, Pa.

QSL cards: 100 two color, 95c, 150 Government cards, \$2.50. Message blanks, stationery, etc. H. M. Selden, Cranestville, Penn.

QSL cards, western hams prompt service. Plain \$1.00 per hundred, government \$2.00 hundred. Your John Henry, QRA and call with bill brings 'em. Samples gratis. 6LB, Mt. Montgomery, Nevada.

SELL Western Electric 7A amplifier with three 216As new \$24.00. 15 dial Omnigraph and 35 dials, \$17.50. Weston flush 0-500 M.A. \$4.80. R. E. Mummert, 307 Lewis St., Harrisburg, Pa.

HERE'S what you have been looking for! Complete diagram and explanation RCA ET-3629 500 cycle ACW transmitter with receiver, storage battery auxiliary and charging panel. Just what you need for the Commercial Operator's examination. Price fifty cents. C. O. Slyfield, 8LA, Frankfort, Michigan.

VT1—genuine W. E. \$1.50 each. Genuine VT14 5 watters \$3.00. Guaranteed tubes our specialty. Tell us your needs. We carry all R.E.L. Short wave equipment. Send stamped envelope for list. Mac, Box 21, Seaford, N. Y.

SET Remler intermediates \$15.00. Sampson band filter, \$7.50, phasatrols \$2.00. 9BRX.

DID you get your station emblem? All who got them last month cannot express themselves on the beauty of them. Cannot be described in words or black and white picture. Sheepskin leather, buff background, letters in red or green. International intermediate before call if desired. The station emblem for those who want the best. Price \$2.50. Money back if not satisfied. Joe Bush, 178 Berkshire Place, Irvington, N. J.

VIBROPLEX keys, used, \$8.00 to \$12.00. Price governs condition. New General Electric Company GH type G10 Neon lamps for television and wavemeters, price \$1.25 each. 0-10 and 0-15 A.C. voltmeters \$2.50 each. 0-100 or 0-300 milliammeters, \$1.65, other ranges \$1.80. 30 Henry 200 milliamperes chokes. Dudlo wound \$2.50 each. 1500 and 7.5 volt center tapped power transformer 100 watts only \$8.75. Sent C.O.D. on request. Send for bargain list. E. P. Hufnagel, 879 S. 18th St., Newark, N. J.

WAVEMETERS calibrated \$1 per curve or 4 for \$3. Guaranteed accurate within 1% on well made instruments. Any wave 13 to 600 meters. 8MY, 1498 Huribut Ave., Detroit, Mich.

CURTIS-Griffith 250-watt power-filament transformers 350-550 each side \$10.50. New Thordarson mounted transformers: 550-volts each side; two 7¼-volt filament windings, each \$20.00; Thordarson 350-550 power transformers mounted \$16.00; 1000-1500 power transformers \$22.00. Thordarson 650-volt power-filament transformers for 7¼-volts \$6.90. Aluminum square foot 85c; Lead square foot 85c. Potter 2-mfd 1000-volt condensers \$2.75. "Ham-List" 4c. James Radio Curtis, 1109 Eighth Avenue, Fort Worth, Texas.

HEADQUARTERS for hams:—Mueller 150-watt input tubes \$15.00. Complete 7¼-watt transmitters: tube, transformer, rectifier, key, etc. 20-40 meters, each \$40.00. 20-40 meter receiver and one step \$17.50. Aerovox 1000-1-mfd Condensers \$2.50; 2500-volt 1-mfd Condensers \$3.25. "Ham-List" 4c. Robert Curtis, 1109 Eighth Avenue, Fort Worth, Texas.

POWER transformers, 1 kw. 2000-2500 v. each side, \$80. 100 watt 350-550 each side, \$3.50. 200 watt filament transformer 3-11 v. \$7.50. 700 watt 1000-1500 v. \$14.80. 700 watt 2000-2500 v. \$21.00. 250 watt 550-700 v. \$10.50. 250 watt 25 cycle 600-800 v. \$14.00. 700 watt 25 cycle 1000-1500 v. \$22.00. 700 watt 25 cycle 2000-2500 v. \$28.00.

Q R A SECTION

200 watt 25 cycle filament transformer 8-11 v. \$11.00.
39 Henry 150 mil choke \$10.00. F. Greben, 9CES, 1927
S. Peoria St., Chicago, Ill.

MOTOR generator bargains almost new 750 Volt 200
Watt Robbins and Myers direct connected on iron base to
110 Volt 60 cycle single phase alternating motor \$45.00.
400 Volt 100 watt direct connected to 110 Volt 60 Cycle
motor \$32.50. Five 400 Volt 150 watt 3500 Speed Emerson
generators only with field resistance each \$9.50. Three
110 Volt 3500 speed alternating current motors with
coupling to direct connect to above generators or any
machine having a 1/2 inch shaft 1/3 H.P. each \$11.00,
also a few larger generators and motor generators.
George H. Harris, 1911 Chicago Ave., Chicago, Ill.

MOTORS for television experimenters 6,000 rpm 100 v.
A.C. or D.C. \$11.50. Add 5 lbs parcel post charges. A
Forbes, 4832 Rice St., Chicago, Ill.

GUARANTEED crystals and blanks. Also cutting and
grinding. Omnigraph \$20.00. 9DRD, Edwardsville,
Kansas.

RUSCO bandpass filter, two 95 kc. transformers \$20.00.
New W. E. 250 watt, \$75.00. New W. E. 50 watt
\$24.00. Power transformer 2-550 750. 7.5 volt windings,
\$18.00. Type UX250 \$7.00. UX281, \$5.25, UX210 oxide
filament greater output \$6.00. Levy, 2050-69th St.,
Brooklyn, N. Y.

WHY pay more for a Wavemeter when you can buy
the new improved Master Radio Wavemeters for \$5.50
and \$8.50 15-200 Meters. Send for complete description
and free wavemeter offer. Specials: G. E. Neon lamps
for television, oscillation indicator, etc.—95c; socket—
20c. Fada 3 1/2 ampere power rheostats—40c. Bradleystats,
type E-210 \$1.50. Special transformer, 7.5 Fil., 215 Volt
plate—\$1.95. Marco Vernier dials—\$1.15. 1/4" Copper
tubing inductance; 4" diameter—12c per turn; 3"—9c.
Pure aluminum, lead, elements. Per pair: 1"x4"—7c.
1"x6"—10c. Extra heavy 12c. 15c. "Quick Service."
Send for free catalog. William Harrison, 35 Ft. Wash-
ington Ave., New York City.

TRANSFORMERS—25, 40, 50, 60 and 500 cycle Plate
and Filament supply transformers to order, any size up
to 5 KW. Transformers for any purpose built to specifications.
Filter chokes for plate supply of any size up to
100 Henry 1000 Milliamperes, specializing in large trans-
formers and filter chokes. Nat G. Scott, New Albany,
Miss.

NEW Polymet filter condensers 2 mfd., 1000 d.c. working
volts, guaranteed \$2.25 each. One Apco "B" charger
\$1.75. Woodrow Darow, Waterford, Conn.

TRANSMITTING and receiving parts. Good bargains.
List 2c. Harry Sonneborn, Michigan Ave., LaPorte,
Indiana.

TRANSFORMER Reclaiming Service. Stop throwing
away valuable burnt out transformers. We replace with
original factory windings. Make previous guarantee.
Audio Transformers, Audio chokes and most "B" units
\$1.00. Correct engineering. If you do radio service you can
make real cash on this—nearly 500%. Also buy burnt
out, sell reclaimed. Inquiries invited. H. A. Sears, 9 S.
Reed Ave., Mobile, Ala.

THE original low capacity Neon tube. Sold only by me.
Its capacity is so low, that when used on an already
calibrated wavemeter, it will not affect the calibration.
The coming wave band changes in 1929 will make an
accurate wavemeter or frequency meter a necessity.
Flashlight bulbs will not do, as they have in the past.
My type "B" is second only to a the-mo-galvanometer so
at \$1.50 you can't go wrong. Television Neon tubes,
\$2.00. Small experimental tube, type "A", 50c. Send me
your name for dope on Neon tubes, and my swell ham
list. Dudlo wound 50h, 150 mil. chokes, \$2.95. G. L.
Lang, 2WW, 2AWH, 1128 Springfield Ave., Irvington,
N. J.

AERO T P.T.G. 30-40-80 meter transmitter, 10x18 panel,
three Jewell meters complete. Also power transformer
100 two 7 1/2 all center tapped, 45 bucks. 8BYL, 614
Lafayette, Jamestown, N. Y.

EXCHANGE—one registered black and white setter doz.
Bench show type and broken to a first class shooting
dog, value \$200, for complete transmitting set wavemeter
and receiver. S. E. Johnson, 1118 Columbian Mutual
Bldg., Memphis, Tenn.

SELL—two Westinghouse Dynamos, rated 27.5V-
350V., 80 mills each. Will deliver 700V. at 100 mills with
inputs in parallel and outputs in series. Complete in
spring mounting and including switch board and filter
less voltmeter—guaranteed first class shape—\$35.00.
Just the thing for 32-volt power supply. Jas. J. Lamb,
1711 Park St., Hartford, Connecticut.

50c straight with copy in following address form only:

1C1F—John Phillips, 666 Brookline Ave., Brookline,
Mass.

1VP—D. R. Greenawalt, 31 Summer St., New London,
Conn.

1WV—Miles W. Weeks, 40 Norfolk Road, Chestnut Hill,
Brookline, Mass.

2BUO—Werner H. Olpe, 14 Brooklyn Ave., Jamaica,
Long Island, N. Y.

sb2IA—Ruben Simas, Rua Riachuelo 19, Curitiba,
Brazil.

sb2AL—J. Levy Silva, Rua Arthur Prado 49, Sao Paulo,
Brazil.

The following stations belong to members of the
A.R.R.L. Headquarters gang. Mail for them should be
addressed care A.R.R.L., Hartford, Conn. When operat-
ing IMK they use personal sines as indicated.

IMK	IBMM-1FL-ISZ G. D.
A.R.R.L. Headquarters	Meserve "dm"
R.B. Parmenter, Chief	ISZ J. J. Lamb "jim"
Op. "r.p."	1BUD A. L. Budlong "bud"
L. R. Huber "ou"	1ES A. A. Hebert "ah"
1AL H. P. Westman "ws"	1KP F. C. Beekley "beek"
1BDI F. E. Handy "fh"	ISZ-1BIZ C. C. Rodimon
1BHW K. B. Warner "kb"	"rod"

Reached Half Way around the World!

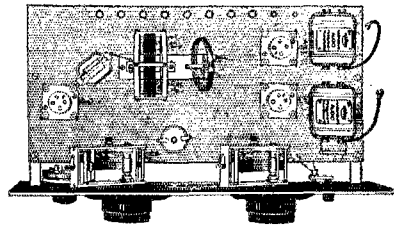

Now—get real short wave results with this fa-
mous set! Uses KARAS Micrometric Dials—
smooth, even tuning, free from backlash,
made of Bakelite; no drilling—only 1 set
screw; 2 knobs, rough tuning and vernier. Also
KARAS Orthometric Variable Condensers built
of the finest materials; greater separation—
broader tuning range! Get complete kit at deal-
ers (only \$58.95). If your dealer does not stock
KARAS parts, send your order direct to us and
we will see that you are supplied.

KARAS ELECTRIC COMPANY
4030G-N. Rockwell Street. Chicago, Ill.

Send for **FREE LITERATURE**
KARAS parts guarantee best results in
any short wave set.

I am—
Have u ordered ur copy of
andy's
andy
Handbook?

THE BEST \$1 YOU EVER SPENT!

PUBLISHED BY
AMERICAN RADIO RELAY LEAGUE
1711 PARK ST. HARTFORD, CONN.

National Rectobulbs



A Nice Job;
Built for the Discriminating Ham;

have established for themselves a reputation for easy and dependable operation; their even and steady note resounds throughout the world.

We are amazed at the number of Hams using Rectobulbs and National 50 watters that are WAC members.

Order your Rectobulbs now and cash in on DX Price \$15 each

Type 203 50 watt tubes "They make good" Price \$20 each

TBI Kenotrons as per May ad \$1.00 each

Rebuilding of tubes is our specialty!
 No tubes smaller than 50 watt repaired.
 All work Guaranteed against defects.

No charge for crating if cash accompanies order.

National Radio Tube Co.

3420 18th St. San Francisco, Calif.

(A Ham Institution)

FOR YOUR CONVENIENCE QST'S INDEX OF ADVERTISERS IN THIS ISSUE

Acme Electric & Mfg. Company	71
Acme Wire Company	2
Aero Products, Inc.	3rd cover
Aerovox Wireless Corporation	88
Allen-Bradley Company	66
Aluminum Company of America	69
American Mechanical Laboratories	79
American Sales Company	65, 89
American Transformer Company	76
Amrad Corporation	75
Aorjema, Inc., Ad.	80
A.R.R.L. Application Blank	85
A.R.R.L. Back Copies	89
A.R.R.L. Binder	70, 95
A.R.R.L. Handbook	81
A.R.R.L. Recommendation Blank	77
A.R.R.L. Special Offer	77
Burgess Battery Company	4th cover
Candler System Company	90
Cardwell Mfg. Corp., Allen D.	72
Central Radio Laboratories	78
Chicago Radio Apparatus Company	88
Crosley Radio Corporation	63
Cunningham, Inc., E. T.	68
Daven Radio Corporation	79
Deutschmann Company, Toke	80
Dodge, C. K.	87
Dongan Electric Mfg. Company	90
Eastern Radio Institute	83
Electric Specialty Company	81
Electro Manufacturing Co.	88
Fansteel Products Company	82
Federal Railway Institute, Inc.	89
Prost, Inc., Herbert H.	86
General Radio Company	2nd cover
Grebe & Company, Inc., A. H.	4
Greben, F.	80
Gulf Radio School	83
Hardwick, Field, Inc.	84
Jacobs, Chas. F.	89
Jewell Electrical Instrument Co.	83
Johnson Company, E. F.	84
Karas Electric Company	69
Kruse, Robert S.	88
Leeds Radio Company	87
Loomis Publishing Co.	72
McGraw Hill Book Company	74
National Company, Inc.	86
National Radio Tube Company	94
Pacent Electric Company	87
Photo Electric Devices, Inc.	87
Pilot Electric Mfg. Company	85
Radio Engineering Labs.	71
Radio Institute of America	64
Rectifier Engineering Service	89
Rooney, John T.	82
Scientific Radio Service	90
Stronberg-Carlson Telephone Mfg. Co.	67
Telenlex Company	82
Televox Corporation	78
Thordarson Electric Mfg. Co.	96
Universal Microphone Company	83
Vibroxplex Company	76
Well's Curiosity Company	84
Waston Electrical Instrument Corp.	79
Wireless Expert	83
Wireless Specialty Apparatus Co.	1
X-L Radio Laboratories	96
Yaxley Manufacturing Company	72

30,000 COPIES

OF THE

Radio Amateur's Handbook

NOW IN USE

THE RADIO AMATEUR'S HANDBOOK first appeared less than a year and a half ago. Our expectations, based on the sales of other Radio books, were greatly exceeded. No other book was ever received with such acclaim by the radio world. The result has been that printing after printing has been rushed off the presses to supply the demand.

We believe that The Radio Amateur's Handbook, by F. E. Handy, Communications Manager, A.R.R.L. is the most valuable book which any amateur or experimenter could own. Its chapter headings will give an idea of the thoroughness with which the subject is covered. They are "What is An Amateur?", "Getting Started", "Fundamentals", "How Radio Signals Are Sent and Received", "Building a Station—The Receiver", "The Transmitter", "Power Supply, Keying and Interference Elimination", "Antennas", "The Wave-meter—Radio Measurements", "The A.R.R.L. Communications Department", "Operating a Station", "The Experimenter".

These chapters each occupy from ten to forty pages—indicating that each subject is treated in a thorough manner. In addition there is an appendix containing a fund of useful data. Then there is an index, occupying six pages, by which the valuable information contained in the book is made available. This is a particularly important point and has been compiled and cross-indexed with great care and thought. Altogether the book contains 256 pages of the most valuable radio information ever found between two covers.

The Radio Amateur's Handbook starts at the beginning and tells what an amateur is, what the League is, what amateur radio is, how to become an amateur, how to learn the code, how to understand what you hear, how to get your license, how to build a simple station, how to build a better station, how to operate your station, how the A.R.R.L. works, how to handle traffic, how to conduct experiments and make measurements, and a multitude of other things too numerous to mention.

Anyone who is at all interested in the technical side of radio can ill afford to be without The Radio Amateur's Handbook.

*If you haven't
a copy of The Radio
Amateur's Handbook you
are missing the largest dollar's
worth in radio today.*

DO IT →
NOW

AMERICAN RADIO RELAY LEAGUE,
HARTFORD, CONN.

Dear Sirs:

Enclosed find my dollar. Please send postpaid (anywhere in the world) my copy of the Handbook.

Name

Address

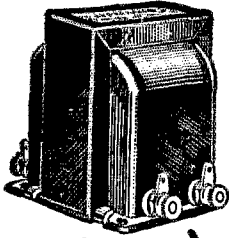

In Most of The Better Radio Receivers

Watch dogs of tone quality safeguarding the musical reproduction of broadcast programs, Thordarson Audio Transformers do their part in making real musical instruments of hundreds of thousands of receiving sets annually.

Among leading set manufacturers, Thordarson transformers have long been recognized for their fidelity of reproduction. Today their use is so universal that it is difficult to find a dealer who does not sell at least one make of receiver so equipped.

Try this simple experiment. Ask your dealer for a demonstration of his receivers. Pick out the instrument with the most natural reproduction, and then look inside the cabinet. You will find, in the majority of cases, Thordarson amplifying and power supply transformers.

You will realize that it is wise to specify Thordarson amplification when buying your receiver, for the manufacturer who is far-seeing enough to equip his sets with Thordarson transformers, may be depended upon to have the balance of his instrument in keeping with this high standard.

new!



THORDARSON
R-300
AUDIO TRANSFORMER

A superior audio transformer that will satisfy the most critical musical ear. The high impedance windings of the R-300 are wound on a core of D-X Metal, a recent development of the Thordarson laboratory. This new core material has an exceedingly high A.C. permeability, and an inductance that is 50% greater than that of the highest grade silicon steel. In performance, this transformer responds exceptionally well to the lower frequencies and provides the same degree amplification to the diapason of the grand organ as to the note of the flute. Ratio 3:1. Dimensions, $2\frac{1}{2}$ " x $2\frac{1}{2}$ " x 3" high. Weight, 2 lbs. Price, \$8.00.

THORDARSON

RADIO TRANSFORMERS

Supreme
in
musical performance

THORDARSON ELECTRIC MANUFACTURING CO.
Transformer Specialists Since 1895
WORLD'S OLDEST AND LARGEST EXCLUSIVE TRANSFORMER MAKERS
Ulton and Kingsbury Streets — Chicago, Ill. U.S.A.

5082

A New and Better SHORT WAVE RECEIVER

The Aero International Four

(Rear Panel
View)

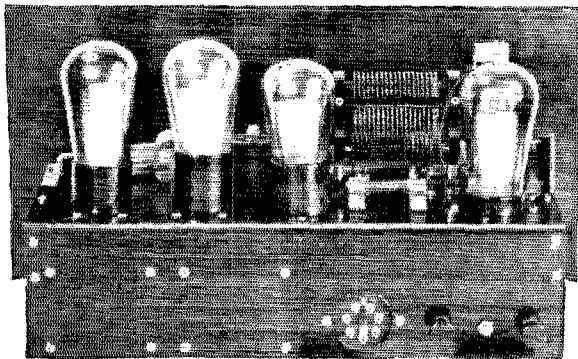

NOTICE

We can furnish all parts for this new receiver, including foundation unit, direct from factory. Write for information, and complete kit price list.

These are the new Aero L. W. T. Coils used in the Aero International Four. Read about them below—then plan to build this superlative set at once!

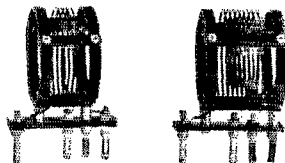

THE new Aero "International Four" Receiver marks a distinct milestone in radio progress. For the first time, radio frequency amplification on short waves has become a possibility. Sensitivity has been increased, control has been made far easier and receiver noises have been reduced considerably below their former level by development in the design of this receiver.

Newly designed parts have been incorporated throughout. The tuning condenser has no metal-on-metal bearing, so that the hissing noises formed by the variation in contact has been eliminated. New coils of a smaller diameter, having a much smaller external field, a better shape factor and improved efficiency are employed. The foundation unit with holes drilled for mounting every part, simplifies the construction of the set, and assures proper placement of the parts. The isolation of the antenna from the tuned stage means that swinging of the antenna will have no effect on tuning and variations in antenna lengths have little effect on the operation of the set.

The Aero "International Four" is to our knowledge the first short wave receiver of any kind designed peculiarly for reception of musical broadcast rather than code reception, and as such fills its place far better than the best of all-purpose outfits, although due to its ease of control and great sensitivity, it is superior to most all perfect short wave sets in any field.

Uses The Aero Coil L. W. T. 10 Kit

The new kit of coils illustrated above is the L. W. T. 10, price \$10.50. This it is designed to go with special drilled and engraved foundation unit, in which mounting base is provided in drilled sub-panel. If you desire to furnish your own foundation unit, order the L.W.T. 11 Kit, price \$11.50. This kit includes mounting base.

The New Aero L. W. T. 12 Coils

This is the new Aero L. W. T. 12 kit. Consists of 3 new small diameter Aero Interchangeable Coils and base mounting with primary coil. A pronounced improvement, even superior to our last season's coils. You should own this kit if you're interested in securing the best in short wave reception performance.



All Parts Can Be Purchased Direct

We have made arrangements to supply a complete kit of all parts of the Aero International Four direct from our factory. Write us today for description literature, list of parts, and special price list. You'll want to build and own this dandy receiver. Send for complete information at once!

AERO PRODUCTS Inc.

Dept. 16

1772 Wilson Ave.

Chicago, Ill.

For Your Own Information~



THE next time you buy Burgess Batteries for your radio set, take a pencil and mark the date on them the day you connect them to the set. Then you will know how long they last.



"Ask any Radio Engineer"

BURGESS BATTERY COMPANY

MADISON, WISCONSIN